

INSTRUCTION SHEET

HS5D / 5E-K / 5L / 5L-K
Door Handle Actuator
HS5 Series

Confirm that the delivered product is what you have ordered. Read this instruction sheet to make sure of correct operation. Make sure that the instruction sheet is kept by the end user.

SAFETY PRECAUTIONS

In this operation instruction sheet, safety precautions are categorized in order of importance to Caution:

WARNING

Warning notices are used to emphasize that improper operation may cause severe personal injury or death.

CAUTION

Caution notices are used where inattention might cause personal injury or damage to equipment.

1 Type

HS9Z-DH5C	Unit	C:	Switch Cover Unit
		C2:	Switch Cover Unit for HS5L-K
		RH:	Right-door Handle Unit, Push-turn Type
		(RHN):	Right-door Handle Unit, Free-turn Type
		LH:	Left-door Handle Unit, Push-turn Type
		(LHN):	Left-door Handle Unit, Free-turn Type
		B:	HS5D Installation Kit

RHN and LHN are not standard. Contact IDEC.

2 Specifications

Applicable Type	HS9Z-DH5C HS9Z-DH5C□HO HS9Z-DH5B HS9Z-DH5C HS9Z-DH5□HO	HS5D Metal Head Interlock Switch Type No. HS5D-□□Z**
		HS5E Key Type Interlock Switch Type No. HS5E-K□□L**△■ HS5L Interlock Switch Rear Unlocking Button Type Type No. HS5L-□44L**△■
		HS5L Key Type Interlock Switch Type No. HS5L-K□□L※※△■
Weight (approx.)		950g (HS9Z-DH5C/HS9Z-DH5C2) 1000g (HS9Z-DH5LH/RH/LHN/RHN) 30g (HS9Z-DH5B)
Mechanical Durability		100,000 operations minimum
Applicable Shackles Diameter of Padlock		φ6 to 7.5
Withstand Load of Padlock		30N minimum
Handle Operation Angle		77 (removed status ⇄ inserted status)
Thickness of mounting frame or panel		70mm maximum

- Interlock switches are not supplied with the door handle actuator and must be ordered separately.
- For the interlock switches, see the specifications of the interlock switches used.

3 Mounting Examples

- Check whether the package contains the following parts.

Unit	Parts	Qty
Switch Cover Unit HS9Z-DH5C	1.Switch Cover	1
	2.Mounting Bracket	1
	3.Blind Cap	1
	4.Screw A *	1
	5.Screw B *	2
	6.Screw C	4
	7.Manual Unlock Label	1
Handle Unit HS9Z-DH5RH HS9Z-DH5LH HS9Z-DH5RHN HS9Z-DH5LHN	8.Actuator Cover	1
	9.Front Handle (black)	1
	10.Back Handle (gunmetal)	1
	11.Back Handle Shaft	1
	12.Back Handle Plate	1
	13.Back Handle Base	1
HS9Z-DH5B Installation Kit	16.Mounting Plate	1
	17.Spacer	2

* Screw A and Screw B are temporarily installed on the mounting bracket, and screw D is temporarily installed on the front handle and back handle.

Installing the Switch Cover Unit (HS9Z-DH5C / HS9Z-DH5C2)

- Remove the screws A and B, and remove the switch cover from the mounting bracket.(Fig. 1)

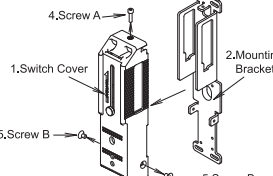

- When using the HS5E-K□□L/HS5L-□□L/HS5L-K□□L interlock switch> Using the screw C, fasten the HS5E-K□□L interlock switch, HS5L-□□L interlock switch or HS5L-K□□L interlock switch on the mounting bracket. (fig. 2-1) (Note 1) Please note you only need 3 screws C to fasten the HS5L-□□L/HS5L-K□□L interlock switch on the mounting bracket (Fig.2.2)

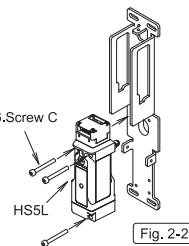
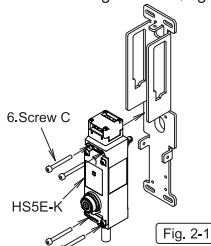

Note1 : When using on an HS5L cable side-routing type (HS5L-□44LSM-G) / HS5L-K Interlock Switch type (HS5L-K□□L), install the main unit plate onto a frame, etc. before installing the Safety Switch.

For details on installing the main unit plate, see step 5).

<When using the HS5D- □□Z Interlock Switch>

Using the mounting plate, two spacers, and two Screws C, install the HS5D-□□Z on the HS5D Installation kit(HS9Z-DH5B)(Fig.2-3).

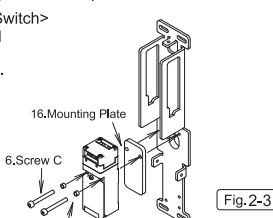

- Of the two actuator entry slots on the switch cover, plug the unused slot using the blind cap.

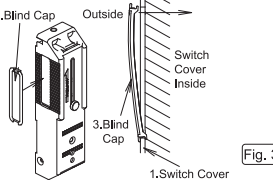

- Install the switch cover on the mounting bracket, and fasten using the Screw A and two Screws B (Fig.4).

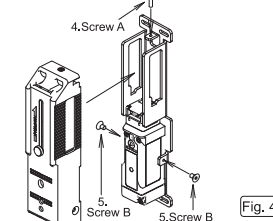

- When installing HS5L-K type safety switch, be sure to use HS9Z-DH5C2. When using HS9Z-KC52, install HS9Z-KC52 for HS5L-K□□L first and then install the main body cover. (Fig.5)

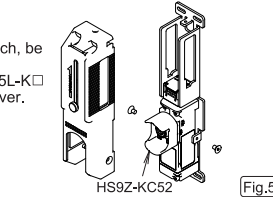

- Fasten the switch cover unit on the mounting frame or panel. Mounting screws and nuts are not supplied and must be provided by the user.

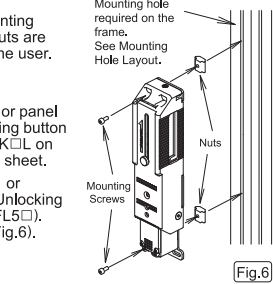

*Installing the Rear Unlocking Button
When the thickness of mounting frame or panel is 3.0mm or less:Install the rear unlocking button of the HS5E-K□□L, HS5L-□□L or HS5L-K□□L on the rod. For details, see the instruction sheet.

When the thickness of mounting frame or panel is over 3.0mm: Install the Rear Unlocking Button Kit for Frame Mounting (HS9Z-FL5□). For details, see the instruction sheet (Fig.6).

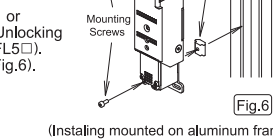

Installing the Handle Unit (HS9Z-DH5RH/RHN)

- Install the front handle (black) on the rod as shown in Fig. 7.

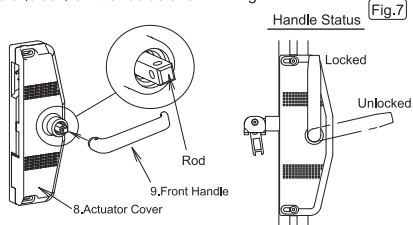

- Tighten the Screw D attached to the handle using the hexagonal wrench (size:2.5) (Fig.8).



- Fasten the handle unit on the mounting frame and panel. Align the handle unit with the switch cover unit (HS9Z-DH5C/HS9Z-DH5C2) referring to 6. Adjustment. Mounting screws and nuts are not supplied and must be provided by the user(Fig.9).

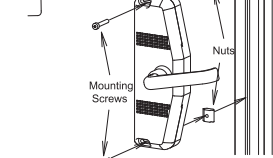

- Cut the back handle shaft according to the thickness of mounting frame and panel.

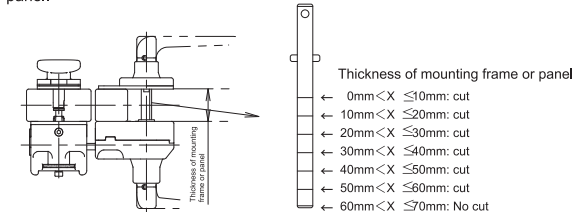

- Align the back handle plate, back handle shaft, and the back handle base as shown below, and fasten using two Screws E (Fig.10).

- Install the back handle (gunmetal) on the back handle shaft (Fig.11).



- Tighten the Screw D attached to the handle using the hexagonal wrench (size:2.5)(Fig.12).

- Turn the handle to the locked position, and insert the back handle shaft into the actuator cover (Fig.13). The back handle should be in the locked position.

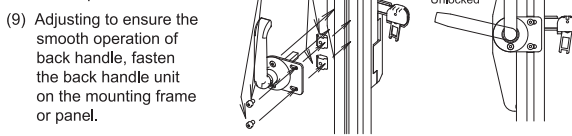

- Adjusting to ensure the smooth operation of back handle, fasten the back handle unit on the mounting frame or panel.

4 Precautions for Operation

CAUTION

- The slide handle actuator can be used with HS5D Metal Head, HS5E-K□□L interlock switch rear unlocking button type,HS5L-□□L interlock switch rear unlocking button type and HS5L-K□□L interlock switch rear unlocking button type only. Do not use with other interlock switches.
- Read instruction sheet before starting operation.
- HS5 Series Safety Switches are Type 2 low-level coded interlocking devices (EN ISO / ISO14119). When using the door handle actuator in the safety-related part of the system,make sure of proper operation while observing the safety standards and the latest regulations of the relevant country or region where the actual machine/system is used. Also, perform risk assessment before operation.

6 Dimensions (mm)

- Mounting Hole Layout (Thickness of mounting frame ≤ 3mm)

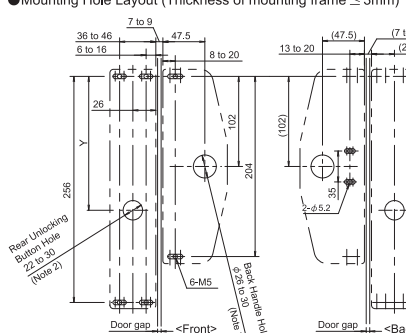

- Mounting Hole Layout (Thickness of mounting frame ≥ 20mm)

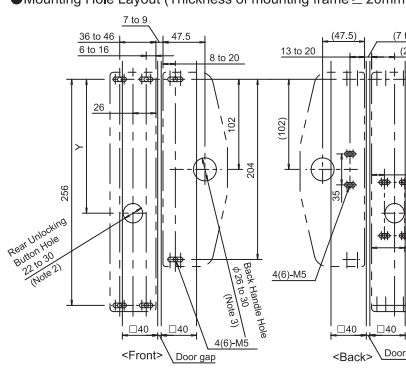

Note: The above mounting hole layout is for □40 frame.

	Y1(mm)
HS5E-K□□L	151.6
HS5L-□□L	147.2
HS5L-K□□L	148.4

Dimensions

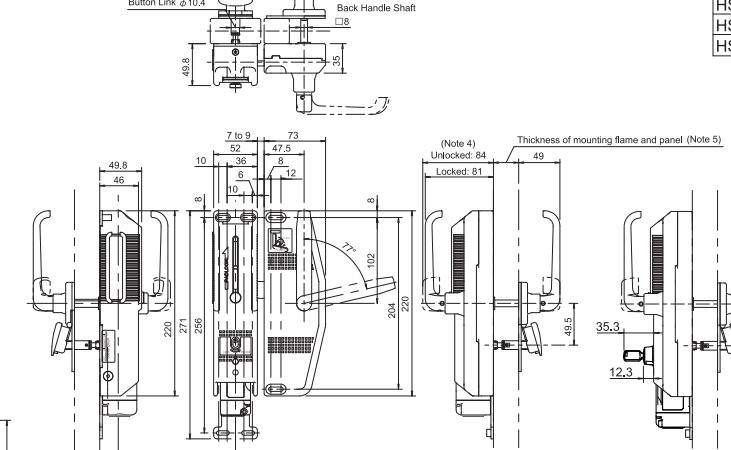

(Installing HS5L)

- Note 2: Mounting hole is required when using the HS5E-K□□L, HS5L-□□L, HS5L-K□□L. Mounting hole is not when using the HS5D-□□Z.
- Note 3: Before operation, ensure to make adjustment so that the back handle shaft does not interfere with the frame.
- Note 4: The value is for Push-turn Type. For Free-turn type, 81mm (locked, unlocked).
- Note 5: Thickness of mounting flange and panel

	Thickness of mounting flange and panel
HS5D-□□Z	≤ 70mm
HS5E-K□□L / HS5L-□□L / HS5L-K□□L	10 to 70mm

- Note 6: When using on an HS5L cable side-routing type (HS5L-□44LSM-G), take the size of the connector (conduit) into consideration when selecting mounting screws.

WARNING

- By using the Door Handle Actuator with the HS5E-K Key interlock switch (HS5E-K, optional), HS5L-K Key interlock switch (HS5L-K, optional) and connecting the EB3N safety relay barrier, the HS5E-K and HS5L-K can be used as an intrinsically safe explosion-proof product.
- When using the explosion-proof cover, affix the nameplate for ExiallBT6, supplied with the EB3N safety relay barrier, where it is easily visible.
- When using in an explosive atmosphere, see the EB3N safety relay instruction manual or the user's manual. (The manuals can be downloaded from IDEC website. http://www.idec.com/japan/)
- If the switch cover unit (HS9Z-DH5C / HS9Z-DH5C2) is used in an explosive atmosphere (When using the switch cover unit (HS9Z-DH5C / HS9Z-DH5C2) in an explosive atmosphere the product must be covered with a grounded metal to prevent static charge. When using the switch cover unit (HS9Z-DH5C / HS9Z-DH5C2) in an electrostatic environment, the product must be covered with a grounded metal to prevent static electricity. Therefore, the main body plate /The mounting screws of the switch cover unit must be grounded. The mounting screws of the switch cover unit should be made of conductive copper or steel for grounding. Please use conductive copper or steel mounting screws for the switch cover unit.
- When using the explosion-proof cover, HS5E-K with rear unlocking button type, and rear unlocking button kit for frame mounting together, do not open a hole larger than the specified size.
- When connecting the lead wire, connect using a junction box. See the instruction manual supplied with the EB3N safety relay barrier.
- When connecting HS5E-K type keyed safety switches and HS5L-K type keyed safety switches to EB3N type safety relay barriers, be careful not to exceed the safety parameter Li≤80μH and Ci≤32nF.

5 Adjustment

Actuator Mounting Reference Position

The mounting reference position and allowable mounting range are as shown on the right.

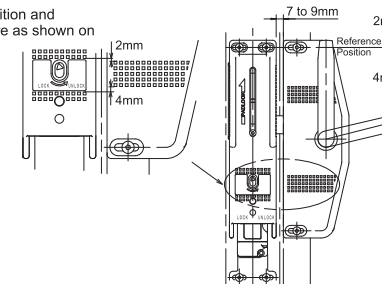

Recommended Tightening Torques

HS9Z-DH5C / HS9Z-DH5C2	Tightening Torque
To install HS5E-K□□L/HS5L-□□L/HS5L-K□□L interlock switch Screw C (M4) *	1.5 to 1.8N · m
To install HS9Z-DH5C unit Three M5 Screws *	4.5 to 5.0 N · m
To install switch cover unit mounting screws Two Screws B (flat-head screw for M5 hexagonal socket), One Screw A for M4 hexagonal socket *	4.5 to 5.0 N · m
HS9Z-DH5RH/RHN/LH/LHN	
To install HS9Z-DH5RH/LH handle unit Two M5 screws each on the front and back *	4.5 to 5.0 N · m
To install Back Handle Base Two Screws E (M5) *	2.5 to 3.0 N · m
To fasten handles One Screw D (M5 hex set screw) *	1.0 to 1.2 N · m

* When the torque is not enough to recommended screw tightening torque, make sure that the screw do not become loose by using adhesive sealants etc.

7 Precaution for Disposal

When disposing of the door handle actuator, do so as an industrial waste.

IDEC CORPORATION

http://www.idec.com
Manufacturer: IDEC CORPORATION, 2-6-64 Nishimiyahara, Yodogawa-Ku, Osaka 532-0004, Japan
EU Authorized Representative: APEM SAS
55, Avenue Edouard Herriot BP1, 82303 Caussade Cedex, France
UK Authorized Representative: APEM COMPONENTS LIMITED
Drakes Drive, Long Crendon, Buckinghamshire, HP18 9BA, UK