

INSTRUCTION SHEET

Safety Controller

SafetyOne

FS1A-C21S

Confirm that the delivered product is what you have ordered. Read this instruction sheet to make sure of correct operation. Make sure that the instruction sheet is kept by the end user.

SAFETY NOTE

In this operation instruction sheet, safety precautions are categorized in order of importance Warning and Caution :

WARNING

Warning notices are used to emphasize that improper operation may cause severe personal injury or death.

CAUTION

Caution notices are used where inattention might cause personal injury or damage to equipment.

WARNING

- Do not disassemble, repair, or modify SafetyOne. This will cause impairment of the safe operability of SafetyOne.
- Turn off the power to SafetyOne before starting installation, removing, wiring, maintenance, or inspection of SafetyOne. This can cause electrical shocks or fire hazard.
- Before operating SafetyOne, carefully read this instruction sheet and the latest user's manual (FS9Z-B1572), and ensure that the environment conforms to the requirements of SafetyOne specifications. If SafetyOne is operated in an environment that exceeds the specifications of SafetyOne, it causes impairment of the safe operation of SafetyOne.
- The installation, wiring, configuration, and operation of SafetyOne must be performed only by "Safety responsible persons". Safety responsible persons are personal who have requisite qualification authorizing them as being capable of safely carrying out each step including the designing, installation, operation, maintenance, and disposal of SafetyOne. Persons without this technical expertise must not use SafetyOne.
- SafetyOne must be subjected to regular proof test verification that each function of SafetyOne is performing up to the required standard.
- Installation of SafetyOne must be performed according to the instructions found in this instruction sheet and the user's manual. Improper installation may cause the SafetyOne to fail.
- Do not use the monitor outputs or solenoid/lamp outputs as safety outputs. When there is a failure in SafetyOne or peripheral devices, impairment of the safe operation of the system is possible.
- The start switch has to be placed outside the danger zone and in a safe position from which there is good visibility for checking that no person is within the danger zone.
- Do not use the start input and the external device monitor input as a safety input. When there is a failure in SafetyOne or peripheral devices, impairment of the safe operation of the system is possible.
- Use the SafetyOne in compliance with laws and regulations of the country in which it is being used.
- Use safety inputs and safety outputs in circuit configurations conforming to the application according to the usage, and the safety requirements.
- Calculate respective safety distances, taking into consideration the response time of the SafetyOne, safety devices to be connected to the SafetyOne, and each other devices that forms a part of the system configuration.
- Applicable safety performance is dependent on each system configuration.
- Use a power supply that meets following required specifications :
 - Conforms to the power supply rating of SafetyOne.
 - Complies with the SELV/ PELV circuit specified by EN 50178 or EN60950-1.
 - Has the functionality or the functional equivalent of the control voltage and current of class 2 circuit, as defined in UL508 or UL1310.
 - Is in compliance with safety laws and regulations relating to electrical safety, EMC, and like under the laws and regulations of the country in which it is being used.
- Ground the V- line (0V DC) for ground fault diagnosis.
- In the case of a new configuration or modified configuration, be sure to perform a check for each input and output function.
- Implement protective measures that personal, other than safety responsible persons operating the SafetyOne, are unable to modify the configuration.
- Separate SafetyOne from devices and wires which are not according to class 2 circuit requirements.

CAUTION

- SafetyOne is designed for installation within an enclosure. Do not install SafetyOne outside an enclosure. Install SafetyOne in enclosure rated IP54 or higher.
- Install SafetyOne in environments described in the catalog, instruction sheet, and user's manual. If SafetyOne is used in places where the SafetyOne is subjected to high temperature, high humidity, condensation, corrosive gases, excessive vibrations, and excessive shocks then electrical shocks, fire hazard, or malfunction may result.
- Environment for using the SafetyOne is "Pollution degree 2". Use SafetyOne in environments of pollution degree 2 (according to IEC/EN60554-1).
- Prevent SafetyOne from falling while moving or transporting the SafetyOne, otherwise damage or malfunction of the SafetyOne may result.
- Prevent metal fragments and pieces of wire from dropping inside the SafetyOne housing. Ingress of such fragments and chips may cause fire hazard, damage or malfunction.
- Install SafetyOne, so that there is adequate distance from the walls, heat generating bodies, and peripherals, taking into consideration space requirements for maintenance and ventilation.
- Install SafetyOne on 35mm DIN rails with BNL6 mounting clips (sold separately) on both sides of SafetyOne.
- Wire the connectors with conforming cables or ferrules.
- Ground FE terminal to assure electromagnetic compatibility.
- Use common 0V DC, if different power supplies are used for SafetyOne and other devices (ex. safety light curtain).
- Wire the inputs and outputs so that they are separated from power lines.
- When overcurrent flows into output terminals, the protective function turns off the output. However, when overcurrent status lasts long, internal protective elements will fuse. To protect the internal elements, insert fuses of double the rated value to each terminal.
- Use IEC60127 approved fuses on outside of the power line. (This is required for equipment incorporating SafetyOne that is destined for Europe.)
- When disposing of SafetyOne, handle it under the laws and regulations of the country in which it is disposed.

1 Unpacking

- Before installing the FS1A-C21S, make sure that following items are contained completely without damage during transportation.

Item	Type Number	Number
Module	FS1A-C21S	1
Connector (input / output)	FS9Z-CN01 / FS9Z-CN02	1 for each
Configuration tool		1
Marking tie	FS9Z-MT01	3
Instruction sheet (English / Japanese)	B-1570 / B-1571	1 for each

2 Dimensions and Parts Descriptions

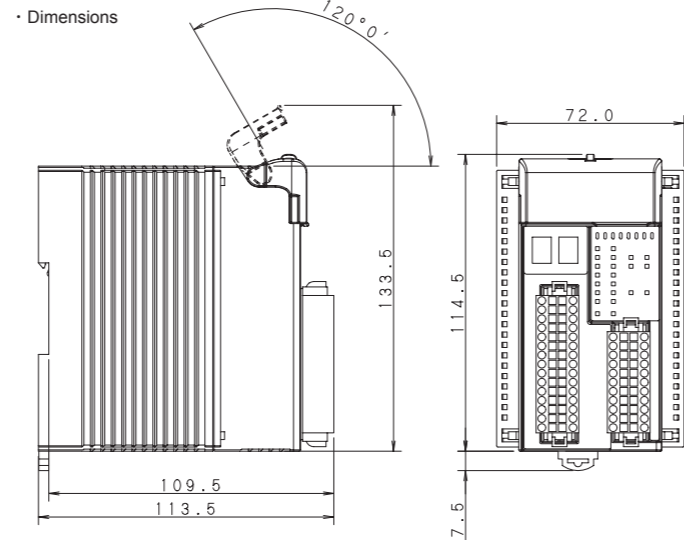

Parts descriptions

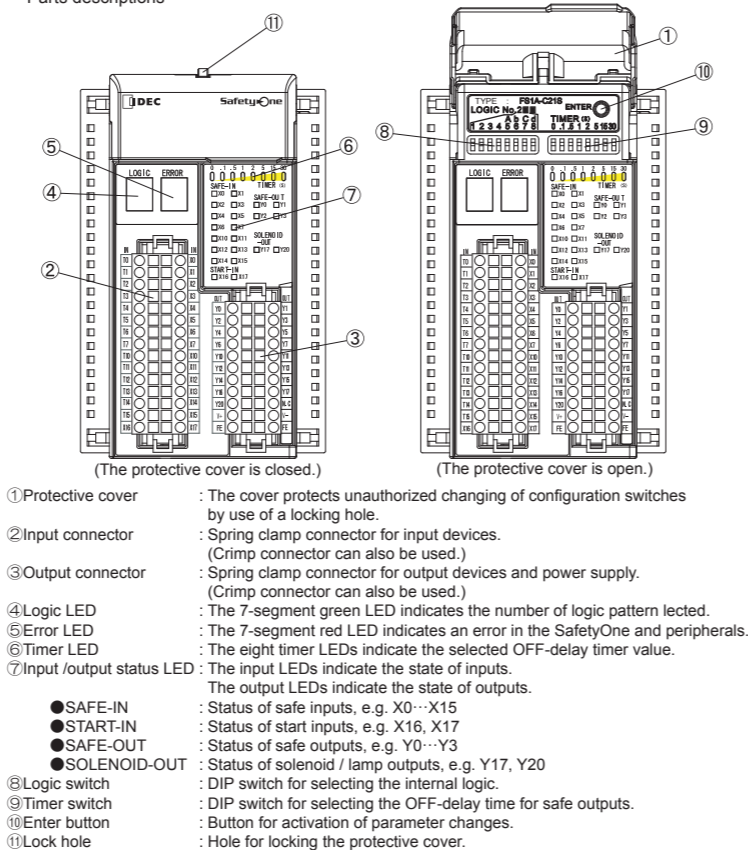

3 Product Specifications

General specifications

Operating temperature (Surrounding air temperature)	-10 to +55°C (no freezing)
Relative operating humidity	10 to 95% (non-condensing)
Storage temperature	-40 to +70°C (no freezing)
Relative storage humidity	10 to 95% (non-condensing)
Pollution degree	2 (IEC/EN60664-1)
Degree of protection	IP20 (IEC/EN60529)
Corrosion immunity	Atmosphere be free from corrosive gas
Altitude	Operation : 0 to 2000m (0 to 6565 feet) Transportation : 0 to 3000m (0 to 9840 feet)
Vibration resistance	Vibration : 5 to 8.4Hz amplitude 3.5mm, 8.4 to 150Hz acceleration 9.8m/s ² (1G) 2 hours per each of XYZ axes (IEC/EN60068-2-6) Bump : Acceleration 98m/s ² (10G) 16ms duration 1000 times per each of XYZ axes (IEC/EN60068-2-29)
Shock resistance	147m/s ² (15G), 11ms duration, 3 times per each of XYZ axes (IEC/EN60068-2-27)
Connector durability	50 times maximum
Operation strength of configuration switches	100 operations maximum (per 1 switch)
Operation strength of enter button	1000 operations maximum
Enclosure material	Modified-Poly Phenylene Ether (m-PPE)
Weight	Approx. 330g
Life time	10 years (at 40 °C of operating temperature)
Over voltage category	II

Operating conditions

Rated voltage	24V DC
Allowable voltage range	20.4V DC to 28.8V DC
Power consumption	48W (at rated voltage, all inputs and outputs are ON, includes output loads)
Allowable momentary power interruption	10ms minimum (at rated voltage)
Reaction time	ON to OFF : 40ms maximum ^{Note1} 50ms maximum (in case of logic 22b and 22C) ^{Note1} 100ms maximum ^{Note2} OFF to ON : 100ms maximum ^{Note3}
Start-up time ^{Note4}	6s maximum
Dielectric strength	Between live part and FE terminal : 500V AC 1minute Between enclosure and FE terminal : 500V AC 1minute
Insulation resistance	Between live part and FE terminal : 10MΩ minimum (at 500V DC megger) Between enclosure and FE terminal : 10MΩ minimum (at 500V DC megger)
Noise immunity (Noise simulator)	DC power terminals : 1.0kV 50ns to 1μs I/O terminals : 2.0kV 50ns to 1μs (with coupling adapter)
Inrush current	25A maximum
Affect of improper power supply connection	Reverse polarity : No operation, no damage Improper voltage : Permanent damage may occur
Applicable standards	IEC 61508 part1-7, EN ISO13849-1, IEC/EN 62061, IEC/EN 61131-2, IEC/EN 61000-6-2, IEC/EN 61000-6-4, IEC/EN 61326-3-1, IEC/EN 61496-1, ISO 13851, UL 508, CSA C22.2 No.142

Note1 : Time to shut OFF safety outputs after inputs are turned OFF or input monitor error is detected (in case of OFF-delay timer is 0s).

Note2 : Time to shut OFF safety outputs after error is detected (in case of OFF-delay timer is 0s).

Note3 : Time to turn ON safety outputs after safe inputs are turned ON (in case of auto start).

Note4 : Time to change to Run state after power supply is turned ON.

Safety input specifications

Drive terminal specifications (T0, T1, T2, T3, T4, T5, T6, T7, T10, T11, T12, T13, T14, T15)	
Rated drive voltage	Power supply voltage
Minimum drive voltage	Power supply voltage -2.0V
Number of drive terminals	14
Maximum drive current	20mA per port (at 28.8V DC) ^{Note1}
Receive terminal specifications (X0, X1, X2, X3, X4, X5, X6, X7, X10, X11, X12, X13, X14, X15)	
Rated input voltage	24V DC
Input ON voltage	15.0V DC to 28.8V DC
Input OFF voltage	Open or 0V DC to 5.0V DC
Number of receive terminals	14
Rated input current	10 mA per port (at rated voltage)
Input type	Sink type input (PNP input), Type1 (IEC/EN61131-2)
Wiring specifications	
Cable length ^{Note2}	100m maximum (total wiring length per 1 input)
Allowable wiring resistance	300Ω maximum

Note1 : The drive port generates check pulses in order to diagnose input devices and internal circuits. (Wiring and the diagnostic function are different depending on the logic selected. See further information in user's manual "Chapter 5 LOGIC". The basic specifications are the same.)

Note2 : For cables longer than 30m between SafetyOne and connected devices, or wiring drive terminals and receive terminals separately, use grounded shielded cables to assure electromagnetic immunity.

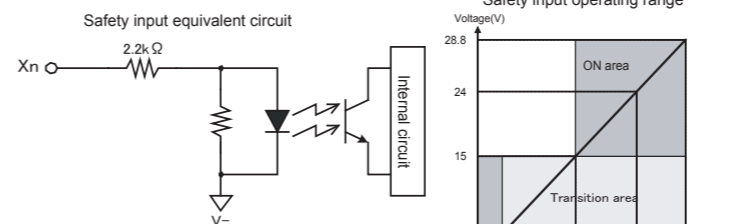

Start input specifications

Rated input voltage	24V DC
Input ON voltage	15.0V DC to 28.8V DC
Input OFF voltage	Open or 0V DC to 5.0V DC
Number of start input terminals	2 (X16, X17)
Input current	5mA per terminal (at rated voltage)
Type of input	Sink type input (PNP input), Type1 (IEC/EN61131-2)
Cable length ^{Note1}	100m maximum (total wiring length per 1 input)
Allowable wiring resistance	300Ω maximum

Note1 : For cables longer than 30m between SafetyOne and connected devices, use grounded shielded cables to assure electromagnetic immunity.

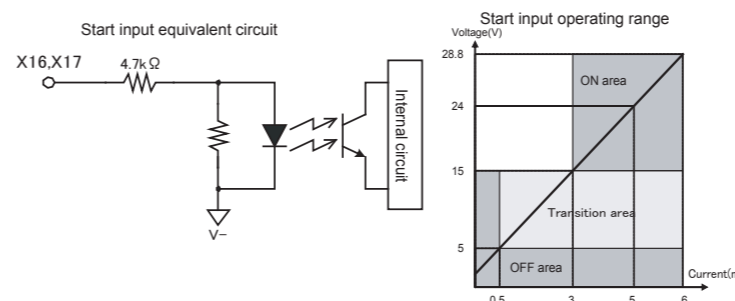

Safety output specifications

Output type	Source output (N channel MOSFET)
Rated output voltage	Power supply voltage
Minimum output voltage	Power supply voltage -2.0V
Number of output terminals	4 (Y0, Y1, Y2, Y3)
Maximum output current	Point : 500mA maximum Total : 1A maximum
Leakage current	0.1mA maximum
Allowable inductive load ^{Note1}	L/R = 25ms
Allowable capacitive load	1μF maximum
Cable length ^{Note2}	100m maximum (total wiring length per 1 output)

Note1 : For protection of output circuits, protection devices such as diodes should be connected to output circuits with inductive loads.

Note2 : For cables longer than 30m between SafetyOne and connected devices, use grounded shielded cables to assure electromagnetic compatibility.

Safety output equivalent circuit

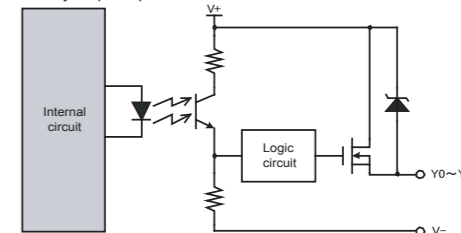

Safety outputs of the SafetyOne are semiconductor outputs. For diagnostics of the shut-off function, the SafetyOne generates off-pulses in certain intervals when the outputs are in ON state. The specifications of the safety outputs change depending on the logic selected. See further information in user's manual "Chapter 5 LOGIC". But the basic specifications are the same.

CAUTION

Check the response time of the external devices so they do not correspond to the off-pulses. Monitor and solenoid/lamp outputs do not generate OFF-pulses.

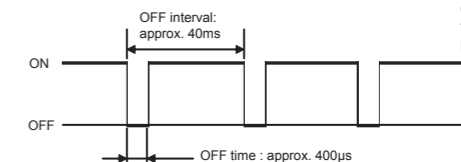

Monitor output specifications

Output type	Source output (N channel MOSFET)
Rated output voltage	Power supply voltage
Minimum output voltage	Power supply voltage -2.0V
Number of output terminals	11 (Y4, Y5, Y6, Y7, Y10, Y11, Y12, Y13, Y14, Y15, Y16)
Maximum output current	Point : 20mA maximum Total : 220mA maximum
Leakage current	0.1mA maximum
Cable length ^{Note1}	100m maximum (total wiring length per 1 output)

Note1 : For cables longer than 30m between SafetyOne and connected devices, use grounded shielded cables to assure electromagnetic compatibility.

Monitor output equivalent circuit

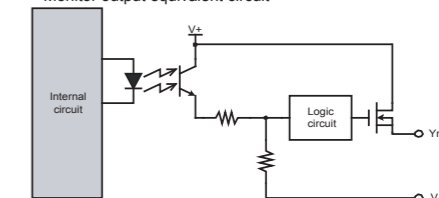

The specifications of the monitor outputs change depending on the logic selected. See further information in user's manual "Chapter 5 LOGIC". The basic specifications are the same.

WARNING

Do not use monitor outputs for safety related purposes. This may cause a loss of safety functions in case of failure of the SafetyOne or peripherals.

Solenoid/lamp output specifications

Output type	Source output (N channel MOSFET)
Rated output voltage	Power supply voltage
Minimum output voltage	Power supply voltage -2.0V
Number of output terminals	2 (Y17, Y20)
Maximum output current	Point : 500mA maximum Total : 500mA maximum
Leakage current	0.1mA maximum
Allowable inductive load ^{Note1}	L/R = 25ms
Cable length ^{Note2}	100m maximum (total wiring length per 1 output)

Note1 : For protection of output circuits, protection devices such as diodes should be connected to output circuits with inductive loads.

Note2 : For cables longer than 30m between SafetyOne and connected devices, use grounded shielded cables to assure electromagnetic compatibility.

Solenoid/lamp output equivalent circuit

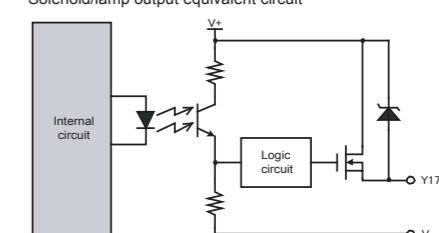

The specifications of the solenoid/lamp outputs changes depending on the logic selected. See further information in user's manual "Chapter 5 LOGIC". But the basic specifications are the same.

WARNING

Do not use solenoid/lamp outputs for safety related purposes. This may cause a loss of safety functions in case of failure of the SafetyOne or peripherals.

Logic number

The logic number of the SafetyOne is composed by a 3-digit code as following.
Example: LOGIC No.204
The first code "2" indicates the type number "FS1A-C21S". Following 2-digit code "04" indicates the state of the logic switch. The logic LED displays this 2-digit code. But "0" is not displayed.

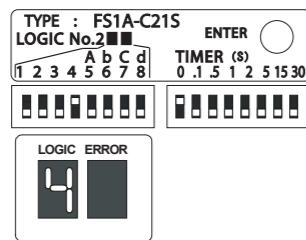

Indicators

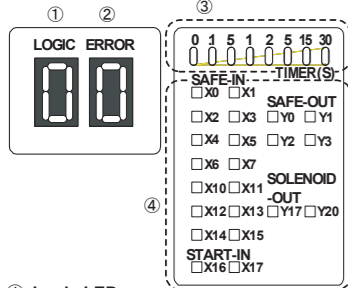

- ① Logic LED (green)
- ② Error LED (red)
- ③ Timer LED (green)
- ④ Input/output status LED (orange)

Logic LED

Indication	Status	Descriptions
"1"..."8"	ON	The selected logic is in Run or Protection state. (Ex. : In case of logic 24A 4 → A → 4 → A → 4 → ...)
"A", "b", "C", "d"	Blink	The selected logic is in Configuration state. (Ex. : In case of logic 24A 4 → A → OFF → 4 → A → OFF → 4 → A → ...)
"E"	Blink	The selected logic has Configuration error (The logic is not selected or incorrect multiple switches are selected ^{*)} .)
Random pattern	ON/Blink	Initializing (Initial state)
Blank	OFF	Error occurs (Stop state)

Note1: Proper logic switch configurations are shown below.
-Select one of "1" to "8" switches.
-Select one of "1" to "4" and one of "A", "b", "C", "d" switches.
Other than above selections are incorrect.

Error LED

Indication	Status	Descriptions
"1"	ON	Input monitor error (Protection state)
"2"	ON	Wiring fault at safety inputs or fault in safety input circuits (Stop state)
"3"	ON	Wiring fault at start inputs or fault in start input circuits (Stop state)
"4"	ON	Wiring fault at safety outputs or fault in safety output circuits (Stop state)
"5"	ON	Muting lamp error (disconnection) (Logics with lamp output) (Stop state) (Software version 1.00 only)
"6"	ON	Power supply error or internal power supply circuit error (Stop state)
"7"	ON	Internal error, power supply error or internal power supply circuit error (Stop state)
"9"	ON	EMC disturbance (Stop state)
"C"	ON	Configuration procedure is in progress (Configuration state)
	Blink	Configuration is valid ^{*)} (Configuration state)
Random	ON/Blink	Initializing (Initial state)
Blank	OFF	Normal operation (Run state)

Note1 : When the enter button is pressed for 1s, the Error LED starts flashing. The enter button should be released the Error LED is flashing so that configuration is valid. (The LED changes from flashing to solid ON when the enter button is pressed for more than 5s and then the set configuration is invalid.)

Timer LED

Indication	Status	Descriptions
"0"	ON	No OFF-delay (safety outputs shut-OFF immediately)
".1"	ON	OFF-delay timer 0.1s
".5"	ON	OFF-delay timer 0.5s
"1"	ON	OFF-delay timer 1s
"2"	ON	OFF-delay timer 2s
"5"	ON	OFF-delay timer 5s
"15"	ON	OFF-delay timer 15s
"30"	ON	OFF-delay timer 30s
Each LED	Blink	Selected timer value (Configuration state)
Random	ON/Blink	Initializing (Initial state)
Blank	OFF	Timer value is not selected or SafetyOne is in the Stop state

Input LED : SAFE-IN (X0 ... X15), START-IN (X16,X17)

Indication	Status	Descriptions
X0...X15	ON	Input ON
	OFF	Input OFF, or SafetyOne is in the Stop state or Configuration state
	Blink	Input monitor error (Blink input number the error occurred, error number is displayed at Error LED)
X16, X17	ON	Input ON
	OFF	Input OFF, or SafetyOne is in the Stop state or Configuration state
	Blink	Input monitor error (Blink input number the error occurred, error number is displayed at Error LED)

Indication specification of input LEDs are different depending on the selected logic.

Output LED : SAFE-OUT (Y0 to Y3), SOLENOID-OUT(Y17,Y20)

Indication	Status	Descriptions
Y0...Y3	ON	Output ON
	OFF	Output OFF, or SafetyOne is in the Stop state or Configuration state
	Blink	During OFF-delay timer operation, or output monitor error (Blink output number the error occurred, error number is displayed in Error LED display)
Y17, Y20	ON	Output ON
	OFF	Output OFF, or SafetyOne is in the Stop state or Configuration state

Specification of configuration switches

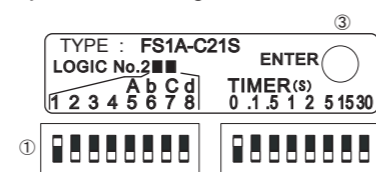

- ① Logic switch
- ② Timer switch
- ③ Enter button

Logic switch

The logic switch is an 8-digit DIP switch for use in logic configuration. When one of "1" to "8" is selected, or one of "1" to "4" and one of "A", "b", "C", "d" are selected, the corresponding logic in SafetyOne is activated. See user's manual "Chapter 5 Logic" for further information on each logic. The upper position of each digit is the ON state. Other than above selections must not be done.

Timer switch

The timer switch is an 8-digit DIP switch for use in OFF-delay timer value configuration. When one of 8 digits is selected, the delay time at shut-off operation is activated. The upper position of each digit is ON state.

Multiple switches must not be selected.

Switch	Indication	Descriptions
0	1	No OFF-delay (safety outputs shut-OFF immediately)
.1	2	OFF-delay timer 0.1s
.5	3	OFF-delay timer 0.5s
1	4	OFF-delay timer 1s
2	5	OFF-delay timer 2s
5	6	OFF-delay timer 5s
15	7	OFF-delay timer 15s
30	8	OFF-delay timer 30s

Enter button

The enter button is used for activation of the configuration.
At the configuration state, when all switches are set properly, pressing this button leads to activation of changed configurations. The configuration is not activated when the switches are not set properly even if the enter button is pressed. The enter button should be pressed for more than 1s and less than 5s. When pressing the button more than 1s and less than 5s, the error LED is flashing. (The LED changes from flashing to solid ON when the enter button is pressed for more than 5s then the change of state is invalid.)

Note: Operate configuration switches with the attached configuration tool.

Connector specifications

Input connector

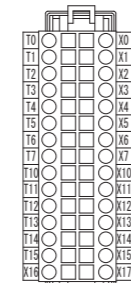

Connector type: -Spring clamp connector (30 poles)
FS9Z-CN01 [IEC]
[Tyco Electronics AMP type No. : 2-1871940-5]
-Crimp connector (30 poles)
[Tyco Electronics AMP type No. : 2-1871946-5]
(For detailed information of the Crimp connector, consult Tyco Electronics AMP.)

Terminal name	Terminal No.	Descriptions	Terminal name	Terminal No.	Descriptions
T0	A1	Safety input drive terminal 0	X0	B1	Safety input receive terminal 0
T1	A2	Safety input drive terminal 1	X1	B2	Safety input receive terminal 1
T2	A3	Safety input drive terminal 2	X2	B3	Safety input receive terminal 2
T3	A4	Safety input drive terminal 3	X3	B4	Safety input receive terminal 3
T4	A5	Safety input drive terminal 4	X4	B5	Safety input receive terminal 4
T5	A6	Safety input drive terminal 5	X5	B6	Safety input receive terminal 5
T6	A7	Safety input drive terminal 6	X6	B7	Safety input receive terminal 6
T7	A8	Safety input drive terminal 7	X7	B8	Safety input receive terminal 7
T10	A9	Safety input drive terminal 10	X10	B9	Safety input receive terminal 10
T11	A10	Safety input drive terminal 11	X11	B10	Safety input receive terminal 11
T12	A11	Safety input drive terminal 12	X12	B11	Safety input receive terminal 12
T13	A12	Safety input drive terminal 13	X13	B12	Safety input receive terminal 13
T14	A13	Safety input drive terminal 14	X14	B13	Safety input receive terminal 14
T15	A14	Safety input drive terminal 15	X15	B14	Safety input receive terminal 15
X16	A15	Start input terminal 16	X17	B15	Start input terminal 17

Output connector

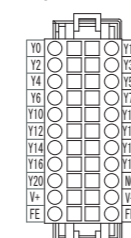

Connector type: -Spring clamp connector (22 poles)
FS9Z-CN02 [IEC]
[Tyco Electronics AMP type No. : 2-1871940-1]
-Crimp connector (22 poles)
[Tyco Electronics AMP type No. : 2-1871946-1]
(For detailed information of Crimp connector, consult Tyco Electronics AMP.)

Terminal name	Terminal No.	Descriptions	Terminal name	Terminal No.	Descriptions
Y0	A1	Safety output terminal 0	Y1	B1	Safety output terminal 1
Y2	A2	Safety output terminal 2	Y3	B2	Safety output terminal 3
Y4	A3	Monitor output terminal 4	Y5	B3	Monitor output terminal 5
Y6	A4	Monitor output terminal 6	Y7	B4	Monitor output terminal 7
Y10	A5	Monitor output terminal 10	Y11	B5	Monitor output terminal 11
Y12	A6	Monitor output terminal 12	Y13	B6	Monitor output terminal 13
Y14	A7	Monitor output terminal 14	Y15	B7	Monitor output terminal 15
Y16	A8	Monitor output terminal 16	Y17	B8	Solenoid/lamp output terminal 17
Y20	A9	Solenoid/lamp output terminal 20	N.C	B9	No connection terminal
V+	A10	Power supply 24V DC terminal	V-	B10	Power supply 0V DC terminal
FE	A11	Functional earth terminal	FE	B11	Functional earth terminal

4 Installation and Wiring

Installation location

When SafetyOne is installed in an enclosure, confirm that installation environments meet the product specification. Using in environments such as described below, (over the product specifications) may cause electric shock, fire hazard, damage, or malfunction.
SafetyOne should not be exposed to excessive dust, dirt, salt, vibration or shocks.
Do not use SafetyOne in an area where corrosive chemicals or flammable gases are present.
Do not use SafetyOne nearby induction heat source.

Mount SafetyOne with enough space from any devices as shown below for maintenance and ventilation. Do not install SafetyOne near, and especially above, any heating device or a heat source.

Use SafetyOne in surrounding air temperature, -10 to 55°C.

Note1: Consider opening and closing of protective cover. (Min. 20mm)

Note2: Consider installation to DIN rail and ventilation characteristic. (Approx. 20mm)

Note3: Consider distance to other devices can be heat source, such as safety relays. (Approx. 40mm)

Note4: Consider wiring the cables connected to input/output connectors. (Approx. 80mm)

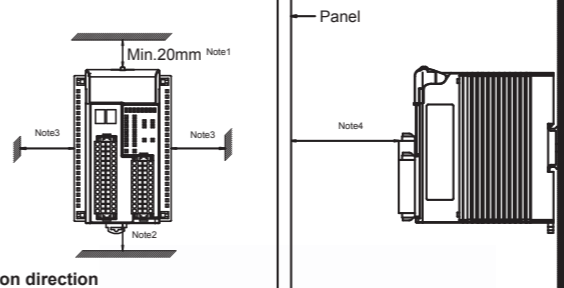

Installation direction

Mount SafetyOne on a vertical plane as shown in Fig.1. All other installation directions are not allowed.

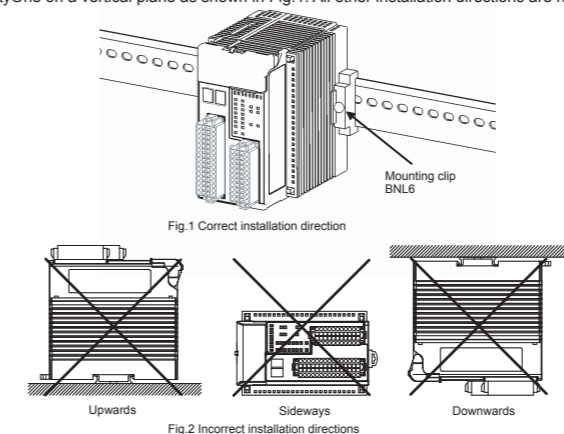

Installation to DIN rail

Mount and remove SafetyOne on a 35mm-wide DIN rail according to the following instructions. Applicable DIN rail : (for example) BAA1000 (IEC)

Mounting on DIN rail

1. Fasten DIN rail to panel using screws.
2. With the top of SafetyOne unit facing up, as shown in Fig.3, insert the groove, on the rear of the unit, and press the unit in direction of the arrow.
3. Use BNL6 mounting clips (sold separately) on both sides of SafetyOne to prevent it from moving sideways.

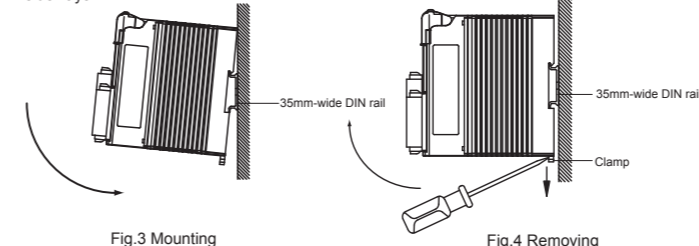

Removing from DIN rail

1. Insert a flat screwdriver into the slot in the clamp.
2. Pull the DIN rail hook until you hear a click, as shown in Fig.4.
3. Remove SafetyOne bottom out.

Wiring method

SafetyOne has two kinds of connectors "spring clamp" and "crimp". Wiring method for spring clamp connector is shown below. (For detailed information of Crimp connector, consult Tyco Electronics AMP.)

Mounting and removing the connector on SafetyOne

When mounting a connector to the SafetyOne, be sure to insert the connector straight and completely in until you hear a click or feel it click into position. To remove the connector, press down on the lock completely, and then pull out the connector. If pressing down on the lock is incomplete damage to the connector and wire may occur.

Applicable wire and ferrule sizes for spring clamp connector

AWG#18 - 24 (UL1007 recommended)
Stripped length : 7.0±0.3mm

When using ferrules, specification are shown below.
Long size : 1.02mm (min.) - 1.21mm (max.) ("a" in the figure below)
Short size : 0.95mm (min.) - 1.21mm (max.) ("b" in the figure below)
Applicable wire : AWG# 24 (UL1007 recommended)

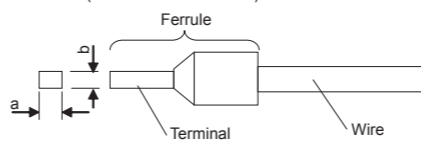

Wiring for spring clamp connector

Do not wire the connector while it is connected to the SafetyOne, as this can damage the connector and the SafetyOne.

To connect the wire, use a connecting tool (FS9Z-SD01 [IEC], 0-2040798-1 [Tyco Electronics AMP]) or a commercially-available screwdriver. It is recommended that you use a dedicated connecting tool to prevent any scratches or damage to the connector housing and spring. When rewiring, use wire with same gauge.

Wiring with a connecting tool

1. Insert the connecting tool into the tool insertion slot on the connector at an angle until the tool comes to a stop.

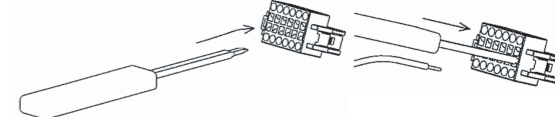

2. Insert the wire into wire insertion slot. (If there are any loose strands, twist the wire to make it even.)

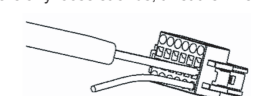

3. With the wire pressed down, remove the connecting tool to finish the wiring. Lightly tug on the wire to check that it is securely connected.

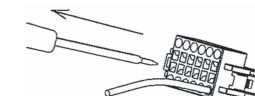

4. To remove the wire, press down the spring with connecting tool, as if you are connecting the wire, and pull out the wire.

Wiring with a commercially-available screwdriver

Use a screwdriver with a tip width that does not exceed 2.4mm. Be careful when wiring with a screwdriver as this can damage the connector.

1. Insert the screwdriver into the tool insertion slot on the connector at an angle, and press down so as to pry open the spring. Be careful not to insert the screwdriver with too much force, as this can damage the connector. Do not insert the screwdriver into the wire insertion slot.
2. With the screwdriver inserted, as described in step 1 above, insert the wire into wire insertion slot. (If there are any loose strands, twist the wire to make it even.)
3. With the wire pressed down, remove the screwdriver to finish the wiring. Lightly tug on the wire to check that it is securely connected.
4. To remove the wire, press down the spring with the screwdriver, as if you are connecting the wire, and pull out the wire.

5 Safety Performance

In the case of using safety outputs as dual channel outputs, SafetyOne can be used in a system for control category B to 4 and performance level a to e in accordance with EN ISO13849-1 (2008). In the case of using safety outputs as single channel outputs, SafetyOne can be used in a system for control category B to 3 and performance level a to d in accordance with EN ISO13849-1 (2008).

Average probability of failure on demand (PFD) and Probability of a dangerous failure per hour (PFH)

- In the case of using safety outputs as dual channel outputs
The following table describes PFD and PFH in the case of dual channel outputs. They are needed for calculation of safety integrity level (SIL) which is applied to a system with SafetyOne. In this case SafetyOne can be used in a system for SIL 1 to 3 in accordance with IEC61508 (2010).

Proof test interval ^{*)}	Average Probability of Failure on Demand (PFD)	Probability of a dangerous Failure per Hour (PFH)
6 months	< 2.1 x 10 ⁻⁶	< 7.1 x 10 ⁻⁸
1 year	< 3.6 x 10 ⁻⁶	
2 years	< 6.7 x 10 ⁻⁶	
5 years	< 1.6 x 10 ⁻⁵ (SIL2)	
10 years	< 3.2 x 10 ⁻⁵ (SIL2)	

- In the case of using safety outputs as single channel outputs

The following table describes PFD and PFH in the case of single channel outputs. They are needed for calculation of safety integrity level (SIL) which is applied to a system with SafetyOne. In this case SafetyOne can be used in a system for SIL 1 to 2 in accordance with IEC61508 (2010).

Proof test interval ^{*)}	Average Probability of Failure on Demand (PFD)	Probability of a dangerous Failure per Hour (PFH)
6 months	< 4.1 x 10 ⁻⁶	< 1.6 x 10 ⁻⁸
1 year	< 7.5 x 10 ⁻⁶	
2 years	< 1.5 x 10 ⁻⁵	
5 years	< 3.6 x 10 ⁻⁵	
10 years	< 7.0 x 10 ⁻⁵	

Note1 : Refer "APPENDIX Maintenance and inspection" in user's manual for proof test procedure.

Mean Time To dangerous Failure (MTTF_d) and Diagnostic Coverage (DC)

- In the case of using safety outputs as dual channel outputs

The following table describes MTTF_d and DC in the case of dual channel outputs. They are needed for the calculation of Performance Level (PL) which is applied to a system with SafetyOne. In this case SafetyOne can be used in a system for PL a to e in accordance with EN ISO13849-1 (2008).

Mean Time To dangerous Failure (MTTF _d)	Diagnostic Coverage (DC)
100 years	High

- In the case of using safety outputs as single channel outputs

The following table describes MTTF_d and DC in the case of single channel outputs. They are needed for the calculation of Performance Level (PL) which is applied to a system with SafetyOne. In this case SafetyOne can be used in a system for PL a to d in accordance with EN ISO13849-1 (2008).

Mean Time To dangerous Failure (MTTF _d)	Diagnostic Coverage (DC)
100 years	Medium

6 Configuration and Operation

Refer the latest user's manual (FS9Z-B1572) for configuration, operation, and wiring, and use properly.

IDEC CORPORATION

6-64, Nishi-Miyahara 2-Chome, Yodogawa-ku, Osaka 532-0004, Japan

IDEC ELEKTROTECHNIK GmbH

Wendenstrasse 331, D-20537, Hamburg, Germany

http://www.idec.com