

EU2B Series: 30mm Hazardous Location Switches EC2B Series: Hazardous Location Control Stations



STANDARDS COMPLIANCE

	Switches	Pilot Lights	Meters	Control Boxes
UL	Class I, Zone 1 AEx d e IIC T6 Gb Class I Div 2, Groups A, B, C and D			
c-UL	Class I, Zone 1, Ex de IIC T6 Gb Class I, Div 2, Groups A, B, C and D	Class I, Zone 1, Ex de IIB T6 Gb Class I, Div 2, Groups C and D	Class I, Zone 1, Ex de IIC T6 Gb Class I, Div 2, Groups A, B, C and D	
ATEX	Ex de IIC tD A21 IP65		Ex de IIC Gb Ex tb IIIC Db IP65	Ex de IIC T6 Gb Ex tb IIIC T80°C Db (dust)
IECEX	EEx PTB 15.0006U IECEX PTB 15.0007U			Ex de IIC T6 Gb Ex tb IIIC T80°C Db (dust)

CERTIFICATE NUMBERS

UL/c-UL	ATEX	IECEX
E347230	PTB 08 ATEX 1053 U PTB 08 ATEX 1003 U PTB 08 ATEX 1048	IECEX PTB 15.0006U IECEX PTB 15.0007U IECEX PTB 15.0032

APPLICABLE STANDARDS

Control Units	Standards	Mark
Pushbuttons Selector Switches Key Selector Switches Pilot Lights Meters (EU2B-YM)	EN60947-5-1	
	UL60079-0 UL60079-1 UL60079-7	
	CAN/CSA C22.2 No. 60079-0 CAN/CSA C22.2 No. 60079-1 CAN/CSA C22.2 No. 60079-7	
	EN60079-0 EN60079-1 EN60079-7 EN60079-31	
Emergency Stop Switches	IEC60079-0 IEC60079-1 IEC60079-7 IEC60079-31	

PRODUCT DESCRIPTION

Complying with UL, IECEX, and ATEX Directives for hazardous environments, new 30mm EU2B Hazardous Location Switches and EC2B Hazardous Location Control Stations provide increased safety for your applications.

Control Unit Options:

- Pushbuttons
- Pilot Lights
- Selector Switches
- Key Selector Switches
- Emergency Stop Switches
- Meters

Control Station Options:

- Pre-configured stations
- Custom-configured stations
- Open control boxes
- Mounting holes for up to 18 control units

KEY FEATURES

- Class I, Zone 1/Division 2
- Applicable in explosive gas atmospheres (AEx de IIC T6 Gb)
- UL Type 4X rated
- Up to 3 contact blocks
- Selector switches available with lever or key
- Selector switches available with overlapping contacts
- Exposed and finger-safe (IP20) screw terminals available
- Corrosion resistant stainless steel enclosure (SUS304)
- Melamine coating
- NPT and Metric reducer options



SPECIFICATIONS

General Specifications

Degree of Protection	IP65 (IEC60529), Type 4X	
Insulation Resistance	100 MΩ minimum (500V DC megger)	
Operating Temperature	-20 to +50°C (no freezing)	
Operating Humidity	45 to 85% (no condensation)	
Altitude	2,000m Maximum	
Pollution Degree	3	
Shock Resistance	Operating Extremes	100-m/s ² Emergency Stop Switch: 150-m/s ² (without Meter)
	Damage Limits	1000-m/s ²
Vibration Resistance	Operating Extremes	5 to 55-Hz, amplitude 0.5 mm Emergency Stop Switch: 5 to 500-Hz, amplitude 0.35-mm, acceleration 50-m/s ² (without Meter)
	Damage Limits	30Hz, amplitude 1.5-mm Emergency Stop Switch: 5 to 500-Hz, amplitude 0.35-mm, acceleration 50-m/s ²

Switches

Rated Insulation Voltage	600V	
Contact Resistance	50mΩ maximum (initial value)	
Impulse Withstand Voltage (Uimp)	6kV	
Insulation Resistance	100MΩ minimum (500V DC megger)	
Short-Circuit Protection	250V/10A fuse (Type aM IEC60269-1/IEC60269-2)	
Conditional Short-Circuit Current	1,000A	
Mechanical Life	Pushbutton	1,000,000 operations minimum
	Selector Switch	500,000 operations minimum
	Key Selector Switch	500,000 operations minimum
	Emergency Stop Switch	50,000 operations minimum
Electrical Life	Pushbutton	250,000 (switching frequency 1800 operations/hr)
	Selector Switch	250,000 (switching frequency 900 operations/hr)
	Key Selector Switch	250,000 (switching frequency 900 operations/hr)
	Emergency Stop Switch	50,000 (switching frequency 900 operations/hr)
Minimum Operator Stroke Required for Direct Opening Action	Emergency Stop Switch	7.0mm
Maximum Operator Stroke	Emergency Stop Switch	9.0mm

Note: Contacts will bounce during operation of pushbuttons and selector switches (reference value: 20- ms). Be sure to take contact bounce time into consideration when designing a control circuit.

Contact Rating (Switches)

Rated Insulation Voltage (Ui)	600V						
Rated Thermal Current (Ith)	10A*						
Rated Operating Voltage (Ue)	24V	120V	240V	500V			
Rated Operating Current (Ie)	AC 50/60Hz	Resistive Load (AC12)	10A*	10A*	6A	2.8A	
		Inductive Load (AC15)	10A*	6A	3A	1.4A	
	DC	Resistive Load (DC12)	8A	2.2A	1.1A	—	
		Inductive Load (DC13)	4A	1.1A	0.55A	—	

Note: Up to 2 contacts (per control unit): 10A

3 contacts (per control unit): 9A

Minimum applicable load: 3V AC/DC, 5mA

Applicable operating locations may vary according to operating conditions and load types.

Contact Rating Code Designation	Thermal Continuous Test Current Amperes	Maximum current, Amperes								Maximum Volt-Amperes	
		120 Volt		240 Volt		480 Volt		600 Volt		600 Volt	
		Make	Break	Make	Break	Make	Break	Make	Break	Make	Break
A600	10	60	6.00	30	3.00	15	1.5	12	1.2	7200	720

Pilot Lights

Rated Insulation Voltage (Ui)	500V	
Rated Operating Voltage (Ue)	Voltage	6V, 12V, 24V AC/DC
	Transformer	120V, 230V, 240V, 380V, 480V AC
Impulse Withstand Voltage (Uimp)	4kV	
Insulation Resistance	100 MΩ minimum (500V DC)	
Frequency	50/60Hz	
Power Consumption (approx.)	Full Voltage	0.3W
	Transformer	1.5VA
Life (reference value)	Approx. 40,000 hours	

Note: Because the built-in LED lamp is a high-brightness version, the lamp may light dimly due to induction even when power is off.

Meters

Accuracy Class	2.5	
Insulation Resistance	100 MΩ minimum (500V DC megger)	
AC ammeter	Rated Insulation Voltage (Ui)	300V
	Operation	Moving core
	Impulse Withstand Voltage (Uimp)	4kV
	Power Consumption	1VA
	Measurement	5A, 10A, 30A, 50A, etc
DC ammeter	Input (CT Ratio)	1A, 5A
	Extended Memory	3 times, etc
	Rated Insulation Voltage (Ui)	150V
	Operation	Moving coil
	Impulse Withstand Voltage (Uimp)	2.5kV
DC ammeter	Input	0 to 10V DC, 4 to 20mA, etc.
	Power Consumption	0.15W
	Consumption Current	1mA

Note: Use a commercially available CT (current transformer) for all AC ammeters, and install the CT in a non-hazardous location.

Control Boxes

Degree of protection	IP65 (IEC60529), Type 4X
Housing Material	Stainless steel (SUS304)
Standard Coating	Melamine
	1-column: Outside coating 2-, 3-, 4-column: Inside and outside coating
Rated Insulation Voltage	600V (with pilot light or ET2A-8PE screw terminal block: 500V) Meter AC input: 300V Meter DC input: 150V
Insulation Resistance	100 MΩ minimum (500V DC megger)
Operating Temperature	-20 to +50°C (no freezing)
Operating Humidity	45 to 85% (no condensation)
Altitude	2000m maximum

Agency Approvals	UL/c-UL, IECEx/ATEX certified	
Applicable Enclosure	All enclosures expect for 6 Control Units x 4 Column	
Mounting Style	Wall Mount	
Control Unit	Pilot Light	Yes ¹
	Pushbutton	Yes
	Emergency Pushbutton	Yes
	Selector Switch	Yes
	Key Selector Switch	Yes
Reducer Screw	Meter	Yes
Degree of Protection	NPT Thread (standard)	
	Metric Thread	
Degree of Protection	IP65, TYPE4X (UL)	
Grounding Terminal Screw Material	Stainless Steel	
Applicable Wire	Stranded Wire (mm ²)	1.5 to 2.5
	Solid Wire (mm ²)	1.2 to 1.6
	Solid/Stranded Wire (AWG)	16-14

1: c-UL explosion protection is different when pilot light is installed.

SWITCHES (CONTROL UNITS)



Pushbuttons



Emergency Stop Switches



Pilot Lights



Selector Switches



Key Selector Switches



Meters

Pushbuttons

EU2B - YB11 F S D

Operator (style / function)

- B1 : Flush pushbutton / Momentary
- B2 : Extended pushbutton / Momentary
- B3 : Mushroom pushbutton / Momentary

Contact arrangement

- 10 : 1NO
- 20 : 2NO
- 30 : 3NO
- 11 : 1NO-1NC
- 21 : 2NO-1NC
- 01 : 1NC
- 02 : 2NC
- 03 : 3NC
- 12 : 1NO-2NC

Button color

- Blank: Red, Green, Black, and White included
- Y : Yellow S : Blue

Terminals

- F : Finger-safe terminal (IP20)
- C : Exposed screw terminal

Part Number	Style and Function	Contact Arrangement	Weight (Approx.)	① Button Color
EU2B-YB110④①-D	Flush Momentary	1NO	68g	① Blank - supplied with red, green, black, and white buttons For yellow or blue buttons, specify Y (yellow) or S (blue).
EU2B-YB101④①-D		1NC		
EU2B-YB111④①-D		1NO-1NC	92g	
EU2B-YB120④①-D		2NO		
EU2B-YB102④①-D		2NC		
EU2B-YB121④①-D		2NO-1NC		
EU2B-YB112④①-D	1NO-2NC	116g		
EU2B-YB130④①-D	3NO			
EU2B-YB103④①-D	3NC			
EU2B-YB210④①-D	Extended Momentary	1NO	70g	Specify a button color code in place of ① in the part number B : black G : green R : red S : blue W : white Y : yellow
EU2B-YB201④①-D		1NC		
EU2B-YB211④①-D		1NO-1NC	94g	
EU2B-YB220④①-D		2NO		
EU2B-YB202④①-D		2NC		
EU2B-YB221④①-D		2NO-1NC		
EU2B-YB212④①-D	1NO-2NC	118g		
EU2B-YB230④①-D	3NO			
EU2B-YB203④①-D	3NC			
EU2B-YB310④①-D	Mushroom Momentary	1NO	76g	
EU2B-YB301④①-D		1NC		
EU2B-YB311④①-D		1NO-1NC	101g	
EU2B-YB320④①-D		2NO		
EU2B-YB302④①-D		2NC		
EU2B-YB321④①-D		2NO-1NC		
EU2B-YB312④①-D	1NO-2NC	125g		
EU2B-YB330④①-D	3NO			
EU2B-YB303④①-D	3NC			

Note: ① Button Color. Specify a contact terminal style in place of ④ in the part number: F (Finger-safe terminal), C (Exposed screw terminal)

Emergency Stop Switches

EU2B - YBV3 11 F R

Operator (style / function)

- BV3 : 40mm mushroom/push, pull or twist release

Contact arrangement

- 01 : 1NC
- 11 : 1NO-1NC
- 02 : 2NC
- 03 : 3NC
- 12 : 1NO-2NC

Button color

- R : Red

Terminals

- F : Finger-safe terminal (IP20)
- C : Exposed screw terminal

Part Number	Operator	Contact Arrangement	Weight (Approx.)	Button Color
EU2B-YBV301④R	ø40 Mushroom	1NC	96g	R : Red
EU2B-YBV311④R		1NO-1NC	120g	
EU2B-YBV302④R		2NC		
EU2B-YBV312④R		1NO-2NC	144g	
EU2B-YBV303④R		3NC		

Specify a terminal style in place of ④ in the part number: F (Finger-safe terminal), C (Exposed screw terminal)

Meters

EU2B - YM 5 3 A 10 F R

Function

- M : Meter

Input current

- 1 : 1A 5 : 5A

Specification of overload scale

- 3 : 3 times 2 : 2 times 5 : 5 times N : Non

Type of meter

- A : AC ammeter

Measuring range

- Direct measuring 1 : 1A 5 : 5A
- For current transformers: 10 : 10A 15 : 15A 20 : 20A 30 : 30A 50 : 50A 60 : 60A 75 : 75A 100 : 100A 150 : 150A

Set pointer

- blank : non -R : with set pointer

Terminals

- F : Finger-safe terminal (IP20)
- C : Exposed screw terminal

EU2B - YM 010 VD F-PER-R

Function

- M : Meter

Input voltage or current

- 010 : 0-10V
- 001 : 0-1mA
- 420 : 4-20mA etc.

Type of meter

- VD : DC voltmeter
- MD : DC ammeter

Set pointer

- blank : non -R : with set pointer

Specification of scale

- PER : 0-100%
- 60HZ : 0-60Hz
- 80HZ : 0-80Hz

Input	Part Number	Description	Weight (approx.)
AC input meter (ammeter)	EU2B-YM53A5④	Capacity: 5A Expansion scale: x3	270g
	EU2B-YM53A10④	Capacity:10/5A Expansion scale: x3	
	EU2B-YM13A10④	Capacity:10/1A Expansion scale: x3	
	EU2B-YM53A15④	Capacity:15/5A Expansion scale: x3	
	EU2B-YM13A15④	Capacity:15/1A Expansion scale: x3	
	EU2B-YM13A20④	Capacity:20/1A Expansion scale: x3	
	EU2B-YM53A30④	Capacity:30/5A Expansion scale: x3	
	EU2B-YM13A30④	Capacity:30/1A Expansion scale: x3	
	EU2B-YM53A50④	Capacity:50/5A Expansion scale: x3	
	EU2B-YM53A60④	Capacity:60/5A Expansion scale: x3	
	EU2B-YM53A75④	Capacity:75/5A Expansion scale: x3	
	EU2B-YM53A100④	Capacity:100/5A Expansion scale: x3	
	EU2B-YM53A150④	Capacity:150/5A Expansion scale: x3	
	DC input meter	EU2B-YM010VD④-PER	
EU2B-YM010VD④-60HZ		0-10V DC Input Scale: 0 to 60Hz	
EU2B-YM001MD④-PER		0-1mA DC Input Scale: 0 to 100%	
EU2B-YM001MD④-60HZ		0-1mA DC Input Scale: 0 to 60Hz	
EU2B-YM001MD④-80HZ		0-1mA DC Input Scale: 0 to 80Hz	
EU2B-YM420MD④-PER		4-20mA DC Input Scale: 0 to 100%	
	EU2B-YM420MD④-60HZ	4-20mA DC Input Scale: 0 to 60Hz	

Specify a terminal style in place of ④ in the part number: F (Finger-safe terminal), C (Exposed screw terminal)

Pilot Lights

Part Number	Type	Operating Voltage	Weight (Approx.)	① Illumination Color Code
EU2B-YL1126④D①	Transformer	120V AC	150g	R : red G : green A : amber Y : yellow PW : white S : blue
EU2B-YL1236④D①		230V AC		
EU2B-YL1246④D①		240V AC		
EU2B-YL1386④D①		380V AC		
EU2B-YL1486④D①		480V AC		
EU2B-YL166④D①	Full Voltage	6V AC/DC	108g	
EU2B-YL111④D①		12V AC/DC		
EU2B-YL122④D①		24V AC/DC		

Note: ① Illumination Color. Specify a contact terminal style in place of ④ in the part number: F (Finger-safe terminal), C (Exposed screw terminal)

EU2B - YL1 22 F D R

Operator (style / function)	Lens/LED Colors	Operating voltage	Terminals
L1 : Pilot Light / dome	R : Red G : Green A : Amber Y : Yellow PW : White S : Blue	126 : AC 120V (Transformer type) 246 : AC 240V (Transformer type) 386 : AC 380V (Transformer type) 486 : AC 480V (Transformer type)	11 : AC/DC 12V (Full voltage type) 22 : AC/DC 24V (Full voltage type) F : Finger-safe terminal (IP20) C : Exposed screw terminal

2 Position Selector Switches

EU2B - YS 2 11 N1 F A

Operator (style / function)	Contact arrangement	Key Removable Position	Terminals	Circuit Number
S : Selector (Knob operator) SK : Key selector (Key operator)	10 : 1NO 03 : 3NC 11 : 1NO-1NC 02 : 2NC 01 : 1NC 21 : 2NO-1NC 30 : 3NO 12 : 1NO-2NC 20 : 2NO 2NC	See option codes below	F : Finger-safe terminal (IP20) C : Exposed screw terminal	Blank : No Designation N* : See charts
Number of Positions / Spring Return Action				
2 : 2-position / Maintained 2R : 2-position / Maintained (Overlap) 2J : 2-position / Maintained (Special function) 21 : 2-position / Spring return from right				
3 : 3-position / Maintained 31 : 3-position / Spring return from right 32 : 3-position / Spring return from left 33 : 3-position / Spring return two-way				

Contact	Mounting	Selector Switches				Key Selector Switches					
		Operator Position		Maintained	Spring Return from Right	Maintained	Spring Return from Right	Maintained	Spring Return from Right		
		L	R	L R	L R	L R	L R	L R	L R		
NO	1		●	EU2B-YS210④	EU2B-YS2110④	EU2B-YSK210④③	EU2B-YSK2110④③				
				EU2B-YS201④	EU2B-YS2101④	EU2B-YSK201④③	EU2B-YSK2101④③				
NC	3	●		EU2B-YS220④	EU2B-YS2120④	EU2B-YSK220④③	EU2B-YSK2120④③				
NO	1		●	EU2B-YS202④	EU2B-YS2102④	EU2B-YSK202④③	EU2B-YSK2102④③				
NO	3		●	EU2B-YS211④	EU2B-YS2111④	EU2B-YSK211④③	EU2B-YSK2111④③				
NC	3	●		EU2B-YS230④	EU2B-YS2130④	EU2B-YSK230④③	EU2B-YSK2130④③				
NO	2		●	EU2B-YS203④	EU2B-YS2103④	EU2B-YSK203④③	EU2B-YSK2103④③				
NO	3		●	EU2B-YS221④	EU2B-YS2121④	EU2B-YSK221④③	EU2B-YSK2121④③				
NC	1	●		EU2B-YS212④	EU2B-YS2112④	EU2B-YSK212④③	EU2B-YSK2112④③				
NC	2	●		EU2B-YS2R11④	N/A	EU2B-YSK2R11④③	N/A				

Key is removable in all maintained positions. Specify key removal position in place of ③ in the part number. See table. Specify a terminal style in place of ④ in the part number: F (Finger-safe terminal), C (Exposed screw terminal).

2-position, 2-position/inverse cam Selector Switch

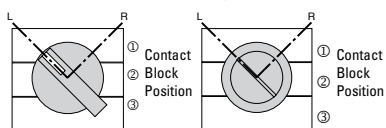

Contact	Mounting	Selector Switches				Key Selector Switches	
		Operator Position		Maintained	Maintained	Maintained	Maintained
		L	R	L R	L R	L R	L R
NO	1	●		EU2B-YS2J10④	EU2B-YSK2J10④③		
				EU2B-YS2J01④	EU2B-YSK2J01④③		
NC	3		●	EU2B-YS2J20④	EU2B-YSK2J20④③		
NO	1	●		EU2B-YS2J02④	EU2B-YSK2J02④③		
NO	3		●	EU2B-YS2J11④	EU2B-YSK2J11④③		
NC	3	●		EU2B-YS2J30④	EU2B-YSK2J30④③		
NO	2		●	EU2B-YS2J03④	EU2B-YSK2J03④③		
NO	3		●	EU2B-YS2J21④	EU2B-YSK2J21④③		
NC	1	●		EU2B-YS2J12④	EU2B-YSK2J12④③		
NC	2		●				
NC	3		●				

③ Key Removable Option Codes (2-position)

Code	Description
A	Key removable in any position
B	Key removable in left position
C	Key removable in right position

3 Position Selector Switches

Contact	Mounting	Operator Position				Selector Switches				Key Selector Switches			
		Operator Position			Maintained	Spring Return from Right	Spring Return from Left	Spring Return Two Way	Maintained	Spring Return from Right	Spring Return from Left	Spring Return Two Way	
		L	C	R	L C R	L C R	L C R	L C R	L C R	L C R	L C R	L C R	
NO	1	●			EU2B-YS320④	EU2B-YS3120④	EU2B-YS3220④	EU2B-YS3320④	EU2B-YSK320④③	EU2B-YSK3120④③	EU2B-YSK3220④③	EU2B-YSK3320④③	
NO	3			●	EU2B-YS320N1④	EU2B-YS3120N1④	EU2B-YS3220N1④	EU2B-YS3320N1④	EU2B-YSK320N1④③	EU2B-YSK3120N1④③	EU2B-YSK3220N1④③	EU2B-YSK3320N1④③	
NO	2	●		●	EU2B-YS311④	EU2B-YS311④	EU2B-YS3211④	EU2B-YS3311④	EU2B-YSK311④③	EU2B-YSK311④③	EU2B-YSK3211④③	EU2B-YSK3311④③	
NO	3			●	EU2B-YS311N1④	EU2B-YS311N1④	EU2B-YS3211N1④	EU2B-YS3311N1④	EU2B-YSK311N1④③	EU2B-YSK311N1④③	EU2B-YSK3211N1④③	EU2B-YSK3311N1④③	
NC	1			■	EU2B-YS311N1④	EU2B-YS311N1④	EU2B-YS3211N1④	EU2B-YS3311N1④	EU2B-YSK311N1④③	EU2B-YSK311N1④③	EU2B-YSK3211N1④③	EU2B-YSK3311N1④③	
NC	3	■			EU2B-YS311N1④	EU2B-YS311N1④	EU2B-YS3211N1④	EU2B-YS3311N1④	EU2B-YSK311N1④③	EU2B-YSK311N1④③	EU2B-YSK3211N1④③	EU2B-YSK3311N1④③	
NC	2		●		EU2B-YS311N2④	EU2B-YS311N2④	EU2B-YS3211N2④	EU2B-YS3311N2④	EU2B-YSK311N2④③	EU2B-YSK311N2④③	EU2B-YSK3211N2④③	EU2B-YSK3311N2④③	
NC	3	■			EU2B-YS311N2④	EU2B-YS311N2④	EU2B-YS3211N2④	EU2B-YS3311N2④	EU2B-YSK311N2④③	EU2B-YSK311N2④③	EU2B-YSK3211N2④③	EU2B-YSK3311N2④③	
NO	1	●			EU2B-YS311N3④	EU2B-YS311N3④	EU2B-YS3211N3④	EU2B-YS3311N3④	EU2B-YSK311N3④③	EU2B-YSK311N3④③	EU2B-YSK3211N3④③	EU2B-YSK3311N3④③	
NC	2		●		EU2B-YS311N3④	EU2B-YS311N3④	EU2B-YS3211N3④	EU2B-YS3311N3④	EU2B-YSK311N3④③	EU2B-YSK311N3④③	EU2B-YSK3211N3④③	EU2B-YSK3311N3④③	
NO	3			●	EU2B-YS311N3④	EU2B-YS311N3④	EU2B-YS3211N3④	EU2B-YS3311N3④	EU2B-YSK311N3④③	EU2B-YSK311N3④③	EU2B-YSK3211N3④③	EU2B-YSK3311N3④③	
NO	2	●		●	EU2B-YS311N4④	EU2B-YS311N4④	EU2B-YS3211N4④	EU2B-YS3311N4④	EU2B-YSK311N4④③	EU2B-YSK311N4④③	EU2B-YSK3211N4④③	EU2B-YSK3311N4④③	
NC	3	■			EU2B-YS311N4④	EU2B-YS311N4④	EU2B-YS3211N4④	EU2B-YS3311N4④	EU2B-YSK311N4④③	EU2B-YSK311N4④③	EU2B-YSK3211N4④③	EU2B-YSK3311N4④③	
NO	1	●			EU2B-YS330④	EU2B-YS3130④	EU2B-YS3230④	EU2B-YS3330④	EU2B-YSK330④③	EU2B-YSK3130④③	EU2B-YSK3230④③	EU2B-YSK3330④③	
NO	2	●		●	EU2B-YS330④	EU2B-YS3130④	EU2B-YS3230④	EU2B-YS3330④	EU2B-YSK330④③	EU2B-YSK3130④③	EU2B-YSK3230④③	EU2B-YSK3330④③	
NO	3			●	EU2B-YS330④	EU2B-YS3130④	EU2B-YS3230④	EU2B-YS3330④	EU2B-YSK330④③	EU2B-YSK3130④③	EU2B-YSK3230④③	EU2B-YSK3330④③	
NC	1			■	EU2B-YS303④	EU2B-YS3103④	EU2B-YS3203④	EU2B-YS3303④	EU2B-YSK303④③	EU2B-YSK3103④③	EU2B-YSK3203④③	EU2B-YSK3303④③	
NC	2		●		EU2B-YS303④	EU2B-YS3103④	EU2B-YS3203④	EU2B-YS3303④	EU2B-YSK303④③	EU2B-YSK3103④③	EU2B-YSK3203④③	EU2B-YSK3303④③	
NC	3	■			EU2B-YS303④	EU2B-YS3103④	EU2B-YS3203④	EU2B-YS3303④	EU2B-YSK303④③	EU2B-YSK3103④③	EU2B-YSK3203④③	EU2B-YSK3303④③	
NO	1	●			EU2B-YS321N1④	EU2B-YS3121N1④	EU2B-YS3221N1④	EU2B-YS3321N1④	EU2B-YSK321N1④③	EU2B-YSK3121N1④③	EU2B-YSK3221N1④③	EU2B-YSK3321N1④③	
NC	2		●		EU2B-YS321N1④	EU2B-YS3121N1④	EU2B-YS3221N1④	EU2B-YS3321N1④	EU2B-YSK321N1④③	EU2B-YSK3121N1④③	EU2B-YSK3221N1④③	EU2B-YSK3321N1④③	
NO	3			●	EU2B-YS321N1④	EU2B-YS3121N1④	EU2B-YS3221N1④	EU2B-YS3321N1④	EU2B-YSK321N1④③	EU2B-YSK3121N1④③	EU2B-YSK3221N1④③	EU2B-YSK3321N1④③	
NC	1			■	EU2B-YS312N1④	EU2B-YS3112N1④	EU2B-YS3212N1④	EU2B-YS3312N1④	EU2B-YSK312N1④③	EU2B-YSK3112N1④③	EU2B-YSK3212N1④③	EU2B-YSK3312N1④③	
NO	2	●		●	EU2B-YS312N1④	EU2B-YS3112N1④	EU2B-YS3212N1④	EU2B-YS3312N1④	EU2B-YSK312N1④③	EU2B-YSK3112N1④③	EU2B-YSK3212N1④③	EU2B-YSK3312N1④③	
NC	3	■			EU2B-YS312N1④	EU2B-YS3112N1④	EU2B-YS3212N1④	EU2B-YS3312N1④	EU2B-YSK312N1④③	EU2B-YSK3112N1④③	EU2B-YSK3212N1④③	EU2B-YSK3312N1④③	

Specify a terminal style in place of ④ in the part number: F (Finger-safe terminal), C (Exposed screw terminal).

Key is removable in all maintained positions. Specify key removal position in place of ③ in the part number. See table.

3-position, 3-position/inverse cam Selector Switch Key Selector Switch

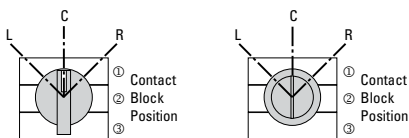

③ Key Removable Option Codes (3-Position)







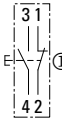
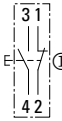
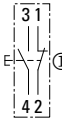
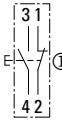

Code	Description
A	Key removable in any position
B	Key removable in left and center positions
C	Key removable in center and right positions
D	Key removable in center position
E	Key removable in left and right positions
G	Key removable in left position
H	Key removable in right position

CONTROL BOXES

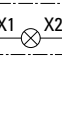
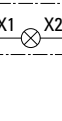
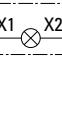
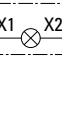
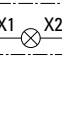

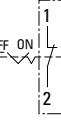

1 control unit	2 control units	3 control units	4 control units	5 control units	4 control units	6 control units	8 control units	10 control units																												
EC2B-B21B011①②-U	EC2B-B21B021①②-U	EC2B-B31B031①②-U	EC2B-B51B041①②-U	EC2B-B51B051①②-U	EC2B-B32B042①②-U	EC2B-B32B062①②-U	EC2B-B52B082①②-U	EC2B-B52B102①②-U																												
1 column					2 columns																															
6 control units	9 control units	12 control units	15 control units	18 control units	① Thread Size <table border="1"> <thead> <tr> <th>Code</th> <th>Description</th> </tr> </thead> <tbody> <tr><td>M1</td><td>M16</td></tr> <tr><td>M2</td><td>M20</td></tr> <tr><td>M3</td><td>M25</td></tr> <tr><td>M4</td><td>M32</td></tr> <tr><td>M5</td><td>M40</td></tr> <tr><td>N1</td><td>NPT1/2</td></tr> <tr><td>N2</td><td>NPT3/4</td></tr> <tr><td>N3</td><td>NPT1</td></tr> <tr><td>N4</td><td>NPT1 1/4</td></tr> </tbody> </table>		Code	Description	M1	M16	M2	M20	M3	M25	M4	M32	M5	M40	N1	NPT1/2	N2	NPT3/4	N3	NPT1	N4	NPT1 1/4	② Terminal Block Style <table border="1"> <thead> <tr> <th>Code</th> <th>Description</th> </tr> </thead> <tbody> <tr><td>blank</td><td>no terminal block</td></tr> <tr><td>C</td><td>Exposed screw terminals</td></tr> <tr><td>F</td><td>Finger-safe terminals</td></tr> </tbody> </table>		Code	Description	blank	no terminal block	C	Exposed screw terminals	F	Finger-safe terminals
Code	Description																																			
M1	M16																																			
M2	M20																																			
M3	M25																																			
M4	M32																																			
M5	M40																																			
N1	NPT1/2																																			
N2	NPT3/4																																			
N3	NPT1																																			
N4	NPT1 1/4																																			
Code	Description																																			
blank	no terminal block																																			
C	Exposed screw terminals																																			
F	Finger-safe terminals																																			
EC2B-B33B063①②-U	EC2B-B33B093①②-U	EC2B-B53B123①②-U	EC2B-B53B153①②-U	EC2B-B63B183①②-U	Specify thread size in place of ① in part number. Specify terminal block style in place of ② in part number (standard versions do not contain a terminal block).																															
3 columns																																				

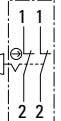
STANDARD CONTROL STATIONS

1 Control Unit × 1 Column

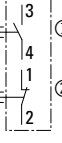

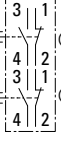
1 pushbutton	EC2B-1102BN2N□1-U	EC2B-1102BN2N□2-U	EC2B-1102BN2N□3-U	EC2B-1102BN2N□4-U	
					
	① Flush momentary 1NO contact Nameplate ON Button color: black, green, red, and white 1NO-1NC contact	① Flush momentary 1NC contact Nameplate OFF Button color: black, green, red, and white	① Flush momentary 1NO-1NC contact Nameplate ON Button color: black, green, red, and white	① Flush momentary 1NO-1NC contact Nameplate OFF Button color: black, green, red, and white	
1 pilot light	EC2B-1101BN2□11-U	EC2B-1101BN2□12-U	EC2B-1101BN2□13-U	EC2B-1101BN2□14-U	EC2B-1101BN2□6-U
					
	① 120V AC Illumination color: red	① 240V AC Illumination color: red	① 24V AC/DC Illumination color: red	① 120V AC Illumination color: green	① 240V AC Illumination color: green ① 24V AC/DC Illumination color: green
1 selector switch	EC2B-1106BN2N□1-U	1 key selector switch	EC2B-1106BN2N□4-U	1 e-stop switch	EC2B-1102BN2N□7-U
					
	① Knob selector 2-position maintained 1NO-1NC contact Name plate OFF-ON		① Key selector 2-position maintained (removable at all positions) 1NO-1NC contact Nameplate OFF-ON		① Emergency stop switch 2NC contact Nameplate EMERGENCY STOP Button color (red)

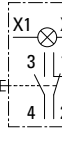
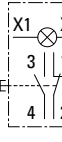
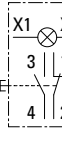
2 Control Units × 1 Column



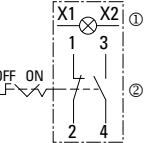
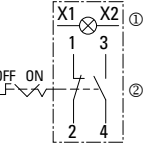

2 flush pushbuttons	EC2B-2102BN2N□1-U	2 Mushroom Pushbuttons	EC2B-2102BN2N□4-U
			
	① Flush momentary 1NO contact, Nameplate ON Button color (black, green, red, and white buttons) ② Flush momentary 1NC contact, Nameplate OFF Button color (black, green, red, and white buttons)		① Mushroom momentary 1NO-1NC contact, Nameplate ON Button color (black) ② Mushroom momentary 1NO-1NC contact, Nameplate OFF Button color (red)
1 pilot light/1 pushbutton	EC2B-2110BN2N□5-U	EC2B-2110BN2N□6-U	EC2B-2110BN2N□3-U
			
	① 120V AC Illumination color: red ② Flush momentary 1NO-1NC contact Name plate STOP Button color (black, green, red, and white buttons)	① 240V AC Illumination color: red ② Flush momentary 1NO-1NC contact Name plate STOP Button color (black, green, red, and white buttons)	① 24V AC/DC Illumination color: red ② Flush momentary 1NO-1NC contact Name plate STOP Button color (black, green, red, and white buttons)

Specify terminal style code in place of □ in part no. C (standard screw terminal), F (finger-safe screw terminal)



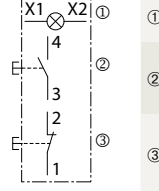
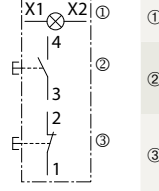
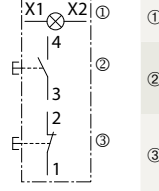

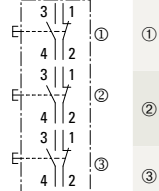
2 Control Units × 1 Column

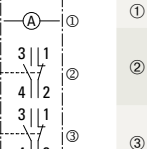
1 pilot light / 1 selector switch	EC2B-2117BN2N□3-U	EC2B-2117BN2N□4-U
		
① 120V AC Illumination color: red	240V AC Illumination color: red	240V AC Illumination color: red
② Knob, 2-position, 1NO-1NC contact Maintained, Name plate OFF-ON		

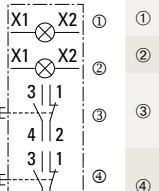
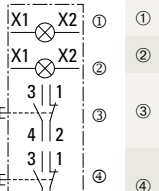
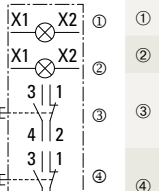

3 Control Units × 1 Column

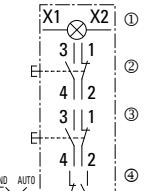
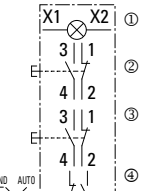
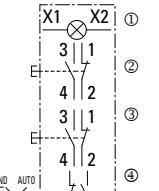
1 pilot light / 2 pushbuttons	EC2B-3110BN2N□5-U	EC2B-3110BN2N□6-U	EC2B-3110BN2N□3-U
			
① 120V AC Illumination color: red	240V AC Illumination color: red	24V AC/DC Illumination color: red	24V AC/DC Illumination color: red
② Flush momentary 1NO contact, Nameplate ON Button color (black, green, red, and white buttons)	Flush momentary 1NO contact, Nameplate ON Button color (black, green, red, and white buttons)	Flush momentary 1NO contact, Nameplate ON Button color (black, green, red, and white buttons)	Flush momentary 1NO contact, Nameplate ON Button color (black, green, red, and white buttons)
③ Flush momentary 1NC contact, Nameplate OFF Button color (black, green, red, and white buttons)	Flush momentary 1NC contact, Nameplate OFF Button color (black, green, red, and white buttons)	Flush momentary 1NC contact, Nameplate OFF Button color (black, green, red, and white buttons)	Flush momentary 1NC contact, Nameplate OFF Button color (black, green, red, and white buttons)
3 pushbuttons	EC2B-3102BN2N□1-U	1 meter / 2 pushbuttons	EC2B-3152BN2N□1△-U
			
① Flush momentary 1NO-1NC contact, Blank nameplate Button color (black, green, red, and white buttons)	① Specify input, capacity, and scale	② Flush momentary 1NO-1NC contact, Nameplate ON Button color (black, green, red, and white buttons)	② Flush momentary 1NO-1NC contact, Nameplate ON Button color (black, green, red, and white buttons)
②	②	③ Flush momentary 1NO-1NC contact, Nameplate OFF Button color (black, green, red, and white buttons)	③ Flush momentary 1NO-1NC contact, Nameplate OFF Button color (black, green, red, and white buttons)
③	③	Specify the meter's capacity and scale in place of △ in the part number	

4 Control Units × 1 Column

2 pilot lights / 2 pushbuttons	EC2B-4110BN3N□5-U	EC2B-4110BN3N□6-U	EC2B-4110BN3N□3-U
			
① 120V AC, Illumination color: red	240V AC, Illumination color: red	24V AC/DC, Illumination color: red	24V AC/DC, Illumination color: red
② 120V AC, Illumination color: green	240V AC, Illumination color: green	24V AC/DC, Illumination color: green	24V AC/DC, Illumination color: green
③ Flush momentary 1NO-1NC contact, Nameplate ON Button color (black, green, red, and white buttons)	Flush momentary 1NO-1NC contact, Nameplate ON Button color (black, green, red, and white buttons)	Flush momentary 1NO-1NC contact, Nameplate ON Button color (black, green, red, and white buttons)	Flush momentary 1NO-1NC contact, Nameplate ON Button color (black, green, red, and white buttons)
④ Flush momentary 1NO-1NC contact, Nameplate OFF Button color (black, green, red, and white buttons)	Flush momentary 1NO-1NC contact, Nameplate OFF Button color (black, green, red, and white buttons)	Flush momentary 1NO-1NC contact, Nameplate OFF Button color (black, green, red, and white buttons)	Flush momentary 1NO-1NC contact, Nameplate OFF Button color (black, green, red, and white buttons)
1 pilot light / 2 pushbuttons / 1 selector switch	EC2B-4113BN3N□5-U	EC2B-4113BN3N□6-U	EC2B-4113BN3N□3-U
			
① 120V AC, Illumination color: red	240V AC, Illumination color: red	24V AC/DC, Illumination color: red	24V AC/DC, Illumination color: red
② Flush momentary 1NO-1NC contact, Nameplate ON Button color (black, green, red, and white buttons)	Flush momentary 1NO-1NC contact, Nameplate ON Button color (black, green, red, and white buttons)	Flush momentary 1NO-1NC contact, Nameplate ON Button color (black, green, red, and white buttons)	Flush momentary 1NO-1NC contact, Nameplate ON Button color (black, green, red, and white buttons)
③ Flush momentary 1NO-1NC contact, Nameplate OFF Button color (black, green, red, and white buttons)	Flush momentary 1NO-1NC contact, Nameplate OFF Button color (black, green, red, and white buttons)	Flush momentary 1NO-1NC contact, Nameplate OFF Button color (black, green, red, and white buttons)	Flush momentary 1NO-1NC contact, Nameplate OFF Button color (black, green, red, and white buttons)
④ Knob, 2-position, maintained 1NO-1NC contact Nameplate HAND-AUTO		Knob, 2-position, maintained 1NO-1NC contact Nameplate HAND-AUTO	

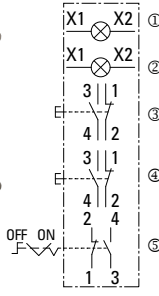
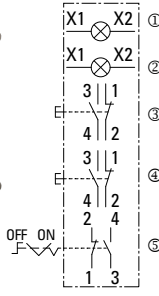
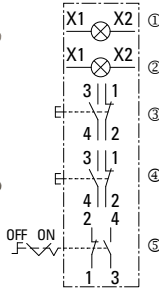
5 Control Units × 1 Column

2 pilot lights / 2 pushbuttons / 1 selector switch	EC2B-5113BN3N□5-U	EC2B-5113BN3N□6-U	EC2B-5113BN3N□3-U
			
① 120V AC, Illumination color: red	240V AC, Illumination color: red	24V AC/DC, Illumination color: red	24V AC/DC, Illumination color: red
② 120V AC, Illumination color: green	240V AC, Illumination color: green	24V AC/DC, Illumination color: green	24V AC/DC, Illumination color: green
③ Flush momentary 1NO-1NC contact, Nameplate ON Button color (black, green, red, and white buttons)	Flush momentary 1NO-1NC contact, Nameplate ON Button color (black, green, red, and white buttons)	Flush momentary 1NO-1NC contact, Nameplate ON Button color (black, green, red, and white buttons)	Flush momentary 1NO-1NC contact, Nameplate ON Button color (black, green, red, and white buttons)
④ Flush momentary 1NO-1NC contact, Nameplate OFF Button color (black, green, red, and white buttons)	Flush momentary 1NO-1NC contact, Nameplate OFF Button color (black, green, red, and white buttons)	Flush momentary 1NO-1NC contact, Nameplate OFF Button color (black, green, red, and white buttons)	Flush momentary 1NO-1NC contact, Nameplate OFF Button color (black, green, red, and white buttons)
⑤ Knob, 2-position, Maintained, 1NO-1NC contact, Name plate HAND-AUTO		Knob, 2-position, Maintained, 1NO-1NC contact Name plate HAND-AUTO	

Specify terminal style code in place of □ in part no. C (standard screw terminal), F (finger-safe screw terminal)

DIMENSIONS

All dimensions in mm

Control Units

Pushbuttons

Shown with finger-safe contacts

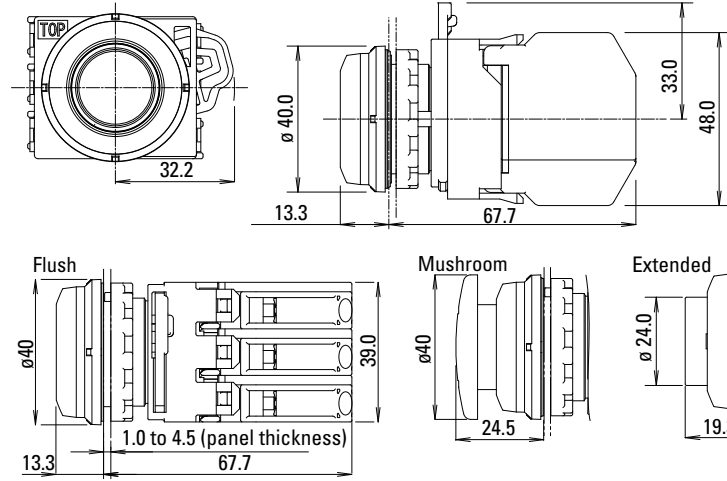

Pilot Lights

Shown with finger-safe contacts

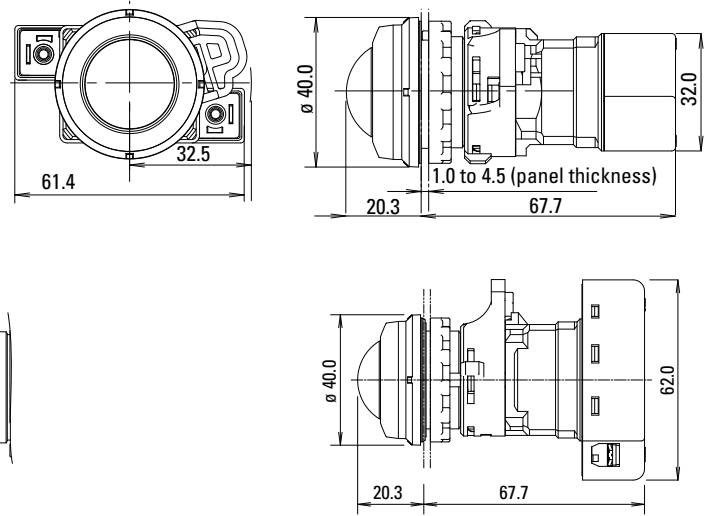

Emergency Stop Switches

Shown with finger-safe contacts

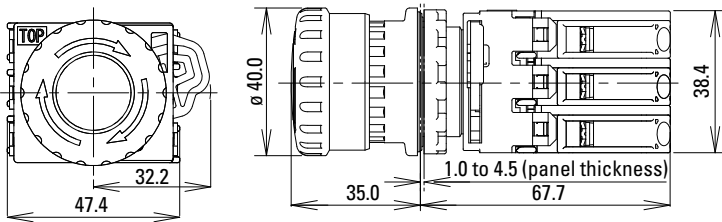

Meters

Shown with finger-safe contacts

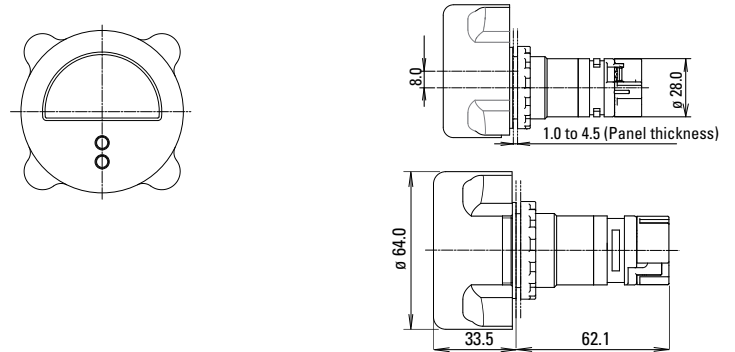

Selector Switches

Shown with finger-safe contacts

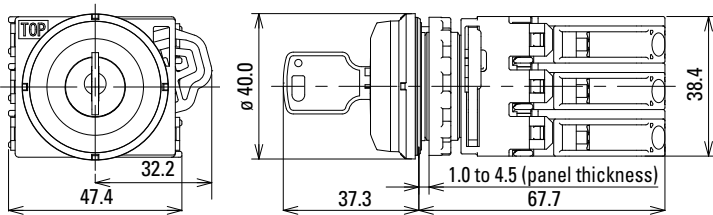

Mounting Hole Dimensions

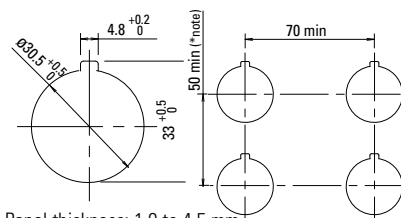

Panel thickness: 1.0 to 4.5 mm.

*Note: The meter can be mounted on the top mounting holes of a standard 50mm mounting centers. The meter can be mounted on any mounting hole with a 70mm or larger mounting center.

Key Selector Switch

Shown with finger-safe contacts

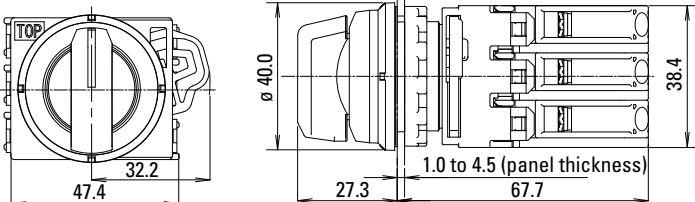

1, 2 control units x 1 column

weight: 1.2kg/1.4kg

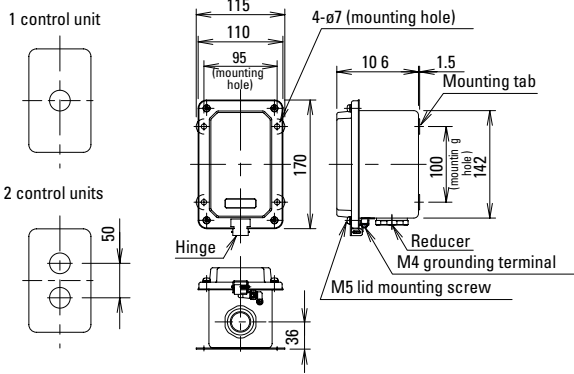

2, 3, 4, 5 control units x 2 columns

weight: 3.8/4.2/4.6/5.0 kg

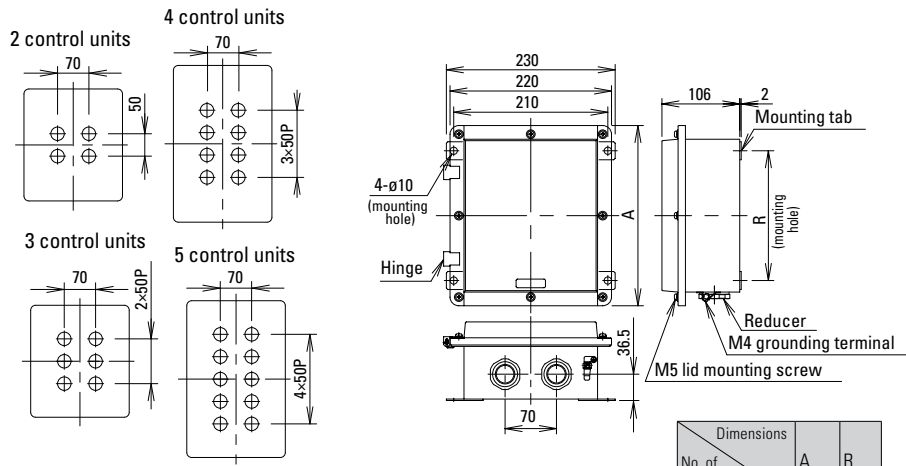

No. of Control Units	Dimensions	
	A	R
2 or 3	250	180
4 or 5	350	280

3 control units x 1 column

weight: 1.8kg

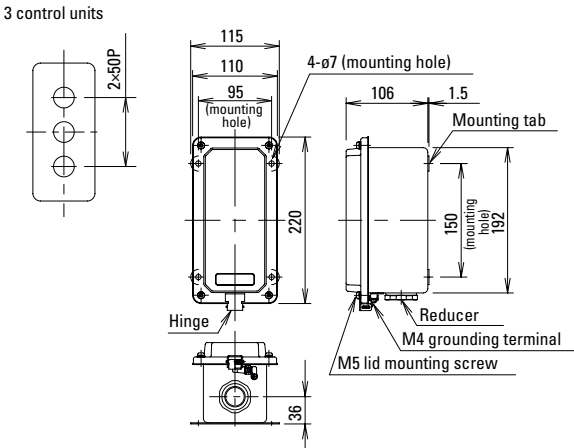

2, 3, 4, 5 control units x 3 columns

weight: 4.8/5.2/6.5/7.1 kg

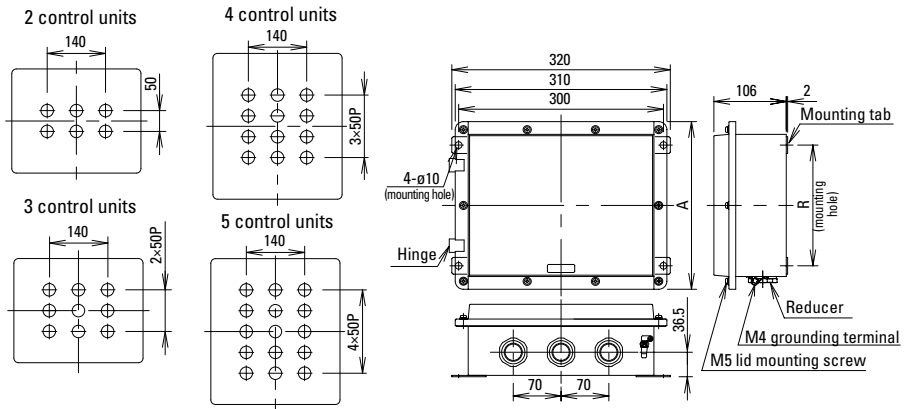

No. of Control Units	Dimensions	
	A	R
2 or 3	250	180
4 or 5	350	280

4, 5 control units x 1 column

weight: 2.4kg

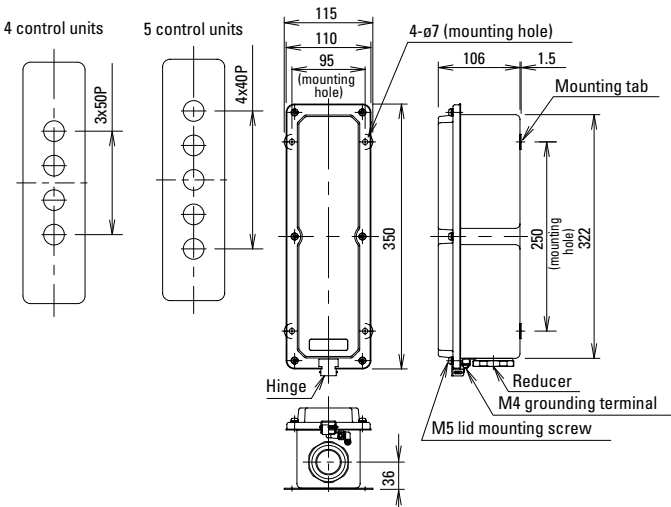

6 control units x 3 columns

weight: 8.1kg

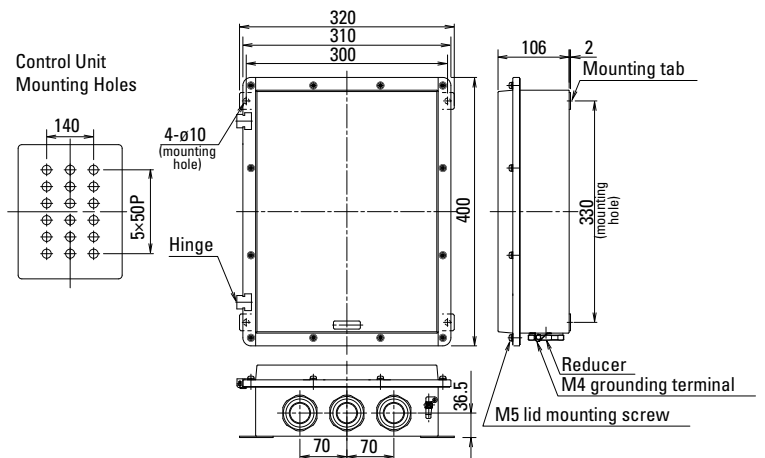

Terminal Blocks

Terminal blocks are not supplied with the standard control boxes (without wiring). When wiring inside the control box is required, specify the wiring circuit. The terminal block type used on the control boxes with wiring depends on the terminal style of the control unit.

C terminal style

exposed screw terminal
ET2A-8PE
polyamide
IECEX TUR 15.0043U,
TUV 15 ATEX 7799U

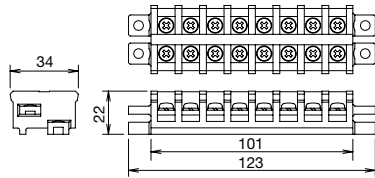

F terminal style

finger-safe screw terminal
IP20 clamp terminal: 264-238 (WAGO)
polyamide
ECEX PTB 04.0003U, PTB 98 ATEX
3129U

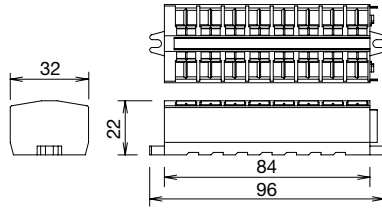

The number of terminal blocks, poles, and the installation direction that can be installed on the control box are as follows:

1-column 1, 2 units (1 terminal block/8 poles) 1-column 3 units (1 terminal block/ 8 poles) 1-column 4, 5 units (1 terminal block/ 8 poles) 2-column 2, 3 units (2 terminal blocks/16 poles)

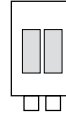
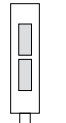
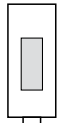
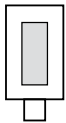

2-column 4, 5 units
(4 terminal blocks/ 32 poles)

3-column 2, 3 units
(3 terminal blocks/ 24 poles)

3-column 4, 5, 6 units
(6 terminal blocks/ 8 poles)

4-column 6 units
(8 terminal blocks/ 64 poles)

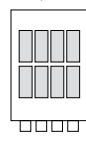
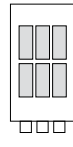
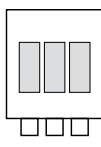
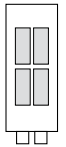

ACCESSORIES

All dimensions in mm

Nameplates

Used for pilot light, pushbutton, selector switch, and key selector switch.

Appearance	Part Number	Dimensions
	EU9Z-NM	

Fittings and Reducers

Reducers installed at the bottom of the control box are as follows: 1 column: 1 reducer, 2 columns: 2 reducers, 3 columns: 3 reducers, 4 columns: 4 reducers. Material is nickel-plated brass. Use cable lead-in fittings that are commercially available. See the following table for optional reducers.

Control Box Style	Part No.	Thread Size	Symbol	UL c-UL
1 column (1 to 3 control units) 2, 3 columns (2, 3 control units)	EC9E-H3M16E-UL	M16	M1	○
	EC9E-H3M20-UL	M20	M2	○
	EC9E-H3M25-UL	M25	M3	○
	EC9E-H3M32-UL	M32	M4	○
	EC9E-H3NPT1-UL	NPT 1/2	N1	○
	EC9E-H3NPT2-UL	NPT 3/4	N2	●
1, 2, 3 columns (4, 5 control units) 3, 4 columns (6 control units)	EC9E-H3NPT3-UL	NPT 1	N3	○
	EC9E-H4M25-UL	M25	M3	○
	EC9E-H4M32-UL	M32	M4	○
	EC9E-H4M40-UL	M40	M5	○
	EC9E-H4NPT2-UL	NPT 3/4	N2	○
	EC9E-H4NPT3-UL	NPT 1	N3	●
	EC9E-H4NPT4-UL	NPT 1 1/4	N4	○

●: Standard reducer ○: non-standard reducer

The reducers in the table above are for replacement use only. All EC2B boxes are supplied with a reducer that has been secured to the housing per UL regulations. If it is necessary to replace a reducer, the user should follow appropriate UL standards for securing to EC2B housing.

Nameplate Inserts

Appearance	Legend	Part Number
	Blank	EU9Z-NP0
	ON	EU9Z-NP1
	OFF	EU9Z-NP2
	START	EU9Z-NP3
	STOP	EU9Z-NP4
	OFF-ON	EU9Z-NP31
	HAND-AUTO	EU9Z-NP35
	HAND-OFF-AUTO	EU9Z-NP53

Material: Aluminum

Installing the Insert to the Nameplate

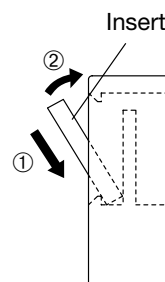

Removing the Insert from the Nameplate

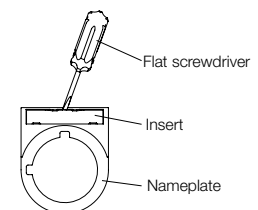



To remove the Insert, insert a flat screwdriver between the Insert and Nameplate.

Rubber Boots

Appearance	Description/Usage	Part Number
For Flush Pushbuttons 	Not for use with name plate	EU9Z-DB1
For Flush Pushbuttons 	For use with name plate	EU9Z-DB1N
For Extended Pushbuttons 	Not for use with name plate	EU9Z-DB2
For Extended Pushbuttons 	For use with name plate	EU9Z-DB2N

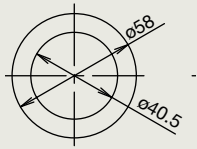
Emergency Stop Switch Nameplate Stickers

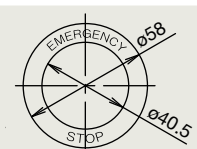
Appearance	Legend	Part Number	Dimensions
	Blank	EU9Z-NVS0	
	Emergency Stop	EU9Z-NVS27	

Material: yellow vinyl Legend: black

Padlock Cover

EU2B-YB2 extended pushbutton: to maintain latched status

EU2B-YB1 flush pushbutton/EU2B-YSK key selector switch: to prevent operation

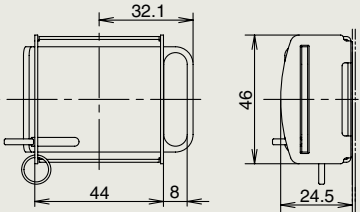
Appearance	Part Number	Dimensions
	EU9Z-PC	

Note: mounted to outside of enclosure with screws, not provided by IDEC

Material: Stainless Steel

Emergency Stop Switch Padlock Cover

Used with EU2B-YBV emergency stop switch to maintain the switch in the latched status.

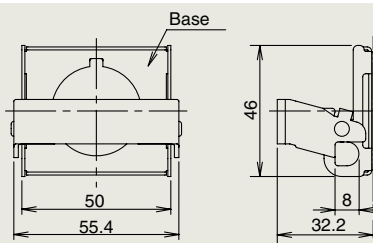
Appearance	Part Number	Dimensions
	EU9Z-PCE	



Coating: yellow Material: Stainless Steel

Mounting Hole Plug

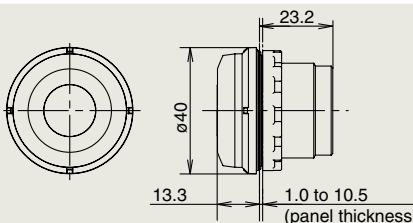
Used to plug unused mounting holes (ø30.5) on the mounting panel.

Appearance	Part Number	Dimensions / Usage
	EU9Z-BP	

Buttons

Appearance	Style	Part Number	Button Color Code
	Flush	HW1A-B1①	Specify a color code in place of ① in the Ordering Number. R : red G : green B : black Y : yellow W : white S : blue
	Extended	HW1A-B2①	
	ø40 Mushroom	HW1A-B4①	

Material: Polyacetal

Lenses

Appearance	Lens Color	Part Number
	Red	EU9Z-LR
	Green	EU9Z-LG
	Amber	EU9Z-LA
	Yellow	EU9Z-LY
	White	EU9Z-LW
	Blue	EU9Z-LS

Material: AS resin (gasket supplied)

LED Lamps



Operating Voltage	Current Draw		Part Number	Illumination Color Code	Base
	AC	DC			
6V AC/ DC±10%	8mA	7mA (A, R, W) 5.5mA (G, PW, S)	LSTD-6①	Specify a color code in place of ① in the part number R : red G : green A : amber PW : white S : blue Use a white (PW) LED with yellow (Y) lens.	BA9S/13
12V AC/ DC±10%	11mA	10mA	LSTD-1①		
24V AC/ DC±10%	11mA	10mA	LSTD-2①		

Control Box Shade

Shape	Part No.	Applicable Control Box	Dimensions (mm)		
			H	W	D
<p>Material: stainless steel Thickness: 1mm Photo: Part No. EC9Z-F2A52</p>	EC9Z-F2A21M	EC2B-11*B EC2B-21*B	180	160	160
	EC9Z-F2A31M	EC2B-31*B	230	160	160
	EC9Z-F2A51	EC2B-41*B EC2B-51*B	360	160	160
	EC9Z-F2A32	EC2B-22*B EC2B-32*B	260	420	160
	EC9Z-F2A52	EC2B-42*B EC2B-52*B	360	420	160
	EC9Z-F2A33	EC2B-23*B EC2B-33*B	260	510	160
	EC9Z-F2A53	EC2B-43*B EC2B-53*B	360	510	160
	EC9Z-F2A63	EC2B-63*B	410	510	160
	EC9Z-F2A64	EC2B-64*B	410	580	160

Protects control units from direct sunlight and rain. The surface of the control box shade is uncoated. Can be installed by tightening to the mounting tabs on the control box. Control box shade cannot be installed later. Specify shade at time of order.

OPERATING INSTRUCTIONS

Installation Area

Do not install the EC2B control box in an environment where more than IP65 protection degree (more than Type 4X in North America) is required.

Use the EC2B control box under ambient temperature of -20 to +50°C. If the control box is exposed to direct sunlight and the surface temperature may rise above 50°C, provide a shade to keep the surface temperature below 50°C.

Installation

Use four M6 bolts for 1-column, four M8 bolts for 2- and 3-column, or other methods with equivalent strength to install the control box. Mounting tab thickness is 1.5mm for 1 column and 2mm for 2, 3, and 4 columns.

- If bolts become may loose due to vibration, use spring washers.
- If bolt corrosion is anticipated, use anti-corrosion bolts or other countermeasures.

Notes on Emergency Stop Switches

When using the emergency stop switches on safety-related parts of the control system, observe safety standards and regulations of the relevant country or region. Also be sure to perform a risk assessment before operation.

Opening/Closing the Lid

Use a Philips screwdriver to loosen lid mounting screws. While holding the unhinged side, open the lid slowly without exerting excessive force on the hinge.

Before closing the lid, make sure of the following:

- No foreign substances are on the packing or joint surfaces.
- No displacement of the waterproof packing.
- Wires are not caught between the joint surfaces.
- Next, close the lid slowly and tighten the screws to a proper torque of 1.6 to 2.4 N·m.

Limitation of the Operating Current

Major heat sources comes from the wiring which is connected to the control box. Therefore, not only the operating current but wiring conditions (size, no. of wires, no. of wire bundles) may cause temperature rise. When wiring, observe the following conditions.

Stranded wire: 1.5 to 2.5 mm² (UL-c-UL certified) / Solid wire: ø1.2 to ø1.6 mm (16 to 14 AWG)

- Maximum no. of wires per bundle: 16
- Maximum operating current: 10A

When using the control box under an operating environment of 40°C minimum, use a heat resistant cable of 70°C minimum.

Determine the operating current so that the total heat value of 1 wire bundle is below 300 [A² × wires]. Also, when calculating the heat value, take the current fluctuation (10%) into consideration. [calculation example: EC2B-41**B (8 circuit)]

① Apply 10A to 1 circuit, 1A to the remaining 7 circuits:
 $\{(10A \times 1.1)^2 \times 2 \text{ wires}\} + \{(1A \times 1.1)^2 \times 14 \text{ wires}\} \approx 259$ (can be used because < 300)

② Apply 10A to 1 circuit, 2A to the remaining 7 circuits:
 $\{(10A \times 1.1)^2 \times 2 \text{ wires}\} + \{(2A \times 1.1)^2 \times 14 \text{ wires}\} \approx 310$ (cannot be used because > 300)

See the table below for the allowable operating current when applying current evenly to each control box.

Allowable Operating Current

Control Box Part No.	Max. No. of Circuits	Max No. of Wires per Bundle (*1) [wires] ([wires] × [bundle])		Allowable Operating Current (reference) (*2)
		Without terminal-blocks	With terminal blocks	
EC2B-11	3	16 (16×1)	8 (8×1)	7A
EC2B-21	6	16 (16×1)	8 (8×1)	5A
EC2B-31	9	16 (16×1)	8 (8×1)	4A
EC2B-41	12	16 (16×1)	16 (16×1)	3A
EC2B-51	15	16 (16×1)	16 (16×1)	3A
EC2B-22	12	32 (16×2)	16 (8×2)	5A
EC2B-32	18	32 (16×2)	16 (8×2)	4A
EC2B-42	24	32 (16×2)	32 (16×2)	3A
EC2B-52	30	32 (16×2)	32 (16×2)	3A
EC2B-23	18	48 (16×3)	24 (8×3)	5A
EC2B-33	27	48 (16×3)	24 (8×3)	4A
EC2B-43	36	48 (16×3)	48 (16×3)	3A
EC2B-53	45	48 (16×3)	48 (16×3)	3A
EC2B-63	54	48 (16×3)	48 (16×3)	3A
EC2B-64	72	64 (16×4)	64 (16×4)	3A

*1: Make sure that the number of wires per bundle is a maximum of 16 by reducing the wiring or by jumper wiring. The maximum number of wires per bundle may need to be further reduced depending on the wire size, lead-in fitting, or conduit size.

*2: The allowable current value (reference) when applying current evenly to all circuits of the maximum number of circuits.

Wiring

Wiring Construction

Observe the laws and regulations in each country concerning wiring construction. Use cable wiring or metal conduit wiring for installation in hazardous locations. If foreign objects or water may enter the box, install a sealing fitting near the cable entry of the box and seal the control box using a compound. Standard type control boxes do not contain a terminal block. Wire the control units directly.

Applicable Wires

Stranded wire: 1.25 to 2.5 mm², solid wire: ϕ 1.2 to ϕ 1.6 mm (AWG16 to 14). Do not connect more than 2 wires to the same terminal.

Applicable crimping terminal

Ring and spade terminals cannot be used for EU2B control units with IP20 finger-safe terminals. Ring and spade terminals cannot be used for IP20 clamp type terminal blocks. When connecting two ferrules to an EU2B control unit, use ferrules without insulating sheath.

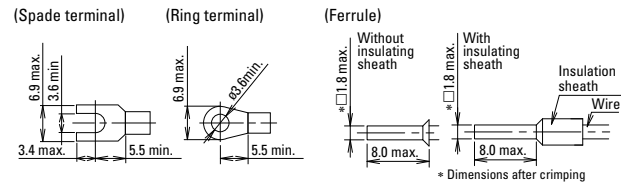

For screw terminal ET2A-8PE

For IP20 clamp terminal
(WAGO: 264-238)

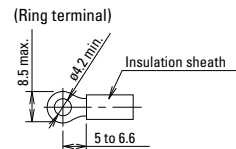

Recommended crimping terminal (WAGO) Ferrule with insulating sheath: 216-204
Ferrule without insulating sheath: 216-104 Crimping plier: 206-204

Recommended Tightening Torque

EU2B control units (M3.5) and ET2A-8PE terminal block (M4): 1.0 to 1.3 N·m

Warning

Incorrect wiring may cause fire hazard. Observe the following conditions.

Be sure to install an insulating sheath on the crimping terminal or the crimping terminal with insulation.

When connecting solid wires or stranded wires directly, strip the insulation as mentioned below, and insert the wire all the way in.

EU2B Control units: 8.6 mm maximum

IP20 crimping terminal: 8 to 9 mm

When using stranded wires, make sure that there are no wire whiskers.

Make sure that the spade crimping terminals and ferrules are inserted all the way in.

Use insulated ring terminals for the ET2A-8PE terminal block. Use only applicable crimping terminals and do not directly connect stranded wires or solid wires.

Removing and Installing the Contact Unit / Lamp Unit

To remove the contact unit or the lamp unit from the operator, pull the protruding yellow part of the locking lever outwards as shown in the figure below using a screwdriver, and turn it to the left. The contact unit or lamp unit can be removed.

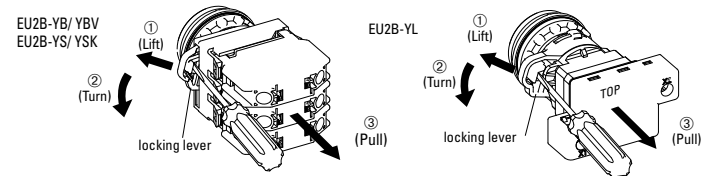

When the contact unit is removed from the emergency stop switch operator, the NO contact closes and the NC contact opens.

Do not turn the locking lever when the contact unit is removed from the operator (the red indicator protruding out, see the figure below) or the switch can be damaged.

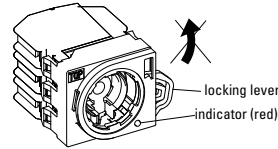

Panel mounting for the operator, lens unit and meter

Remove the locking ring from the operator and check that the rubber gasket is in place. Insert the operator from the panel front into the panel hole. Place the projection on the operator with TOP

(Ring terminal)

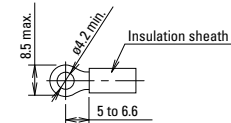

marking upward and the recess on the mounting panel in the same direction. Meters have no projection.

Tighten the locking ring using ring wrench XN9Z-T1 to a torque of 2.5 Nm. When using a nameplate or padlocking cover, install it between the operator and panel. Make sure that the groove of the nameplate or padlocking cover and the projection on the TOP marking of the operator are in the same direction.

Note: The locking ring for emergency stop switches and meter is metallic. The meter can't mount the nameplate or padlocking cover.

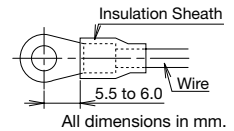

Installing the contact unit and lamp unit

To install the contact unit, place the TOP marking on the operator and the TOP marking on the contact block adapter in the same direction, and then attach the contact unit to the operator. Then turn the locking lever to the right. Follow the same procedure when installing the lamp unit.

When installing the lamp unit, check that the inner lens is not loose.

The contact block adapters for emergency stop switches cannot be used for pushbuttons, selector, or key selector switches.

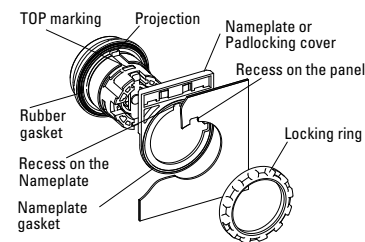

EU2B-YB
EU2B-YS

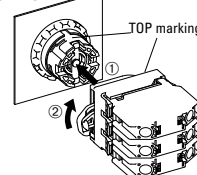

EU2B-YL

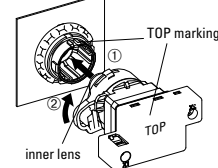

Removing the Contact Block

To remove the contact block, insert a flat screwdriver under the latch of the contact block adaptor and disengage the latch as shown in the figure below.

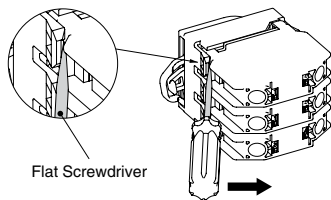

Installing the Contact block

When installing the contact block after maintenance or wiring, make sure that the contact configuration is correct. Installing the contact block in the incorrect position or incomplete installation may cause malfunction of the switch.

Remove the contact block from the operator before installing the contact block to the contact block adaptor. Also make sure that the contact block is correctly installed to the contact block adaptor before attaching the operator. Do not install the contact block adaptor with the operator attached. Otherwise, malfunction may result.

Protective Grounding

Protective grounding must be performed according to the installation environment and rating requirements. Observe laws and regulations set by each country.

- Connect the M4 grounding terminal of the EC2B control box to a proper ground (grounding resistance 10Ω maximum). When operating the EC2B control box by connecting to circuits of 300V or below, the grounding resistance must be 100Ω maximum.
- When using cables, connect one of the cable cores to the grounding terminal in the enclosure.
- If the grounding terminal in the enclosure cannot be used, use the M4 grounding terminal on the outside of the enclosure.

Recommended tightening torque:

M4: 1.0 to 1.3 Nm

M6: 3.9 to 5.4 Nm

- For grounding, use appropriate wires (size, material, insulation) that can tolerate the expected maximum grounding current. Be sure to protect the grounding wire with protection, such as metal conduit, from external damage.

Accessories

Padlock Cover

The following padlocks and hasps can be used.

(Padlock Size)	a	b	c
Flush/extended pushbutton/key selector switch	ø3.5 to 7.0 mm	15 mm min.	70 mm max.
Emergency Stop Switch	ø5.5 to 7.0 mm	—	—

Recommended Hasp

Manufacturer	Part No.
Panduit	PSL-1, PSL-1A, PSL-1.5, PSL-1.5A, PSL-HD1
Master Lock	420, 421

Padlock and hasp are available in various shapes and sizes. Make sure that they do not interfere with the control units. Note: Not supplied by IDEC.

Keep the total weight of padlock and hasp under 1500g max, otherwise the switch may malfunction or result in failure. No vibration should be applied when padlock or hasp are installed. When padlock or hasp are disfigured, stop usage immediately.

Ensure that no shock or electric sparks are generated.

When using the plate lock padlock cover with the extended pushbutton, the switch contact may turn on/off when the cover is being installed. Ensure to provide functional safety measure to prevent unexpected startup.

When using the padlock cover on the safety-related part of the control system, observe safety standards and regulations of the relevant country or region. Also be sure to perform risk assessment before operation.

Installing EU9Z-PC Padlock Cover

(Flush/extended pushbutton/key selector switch)

EU9Z-PC can be installed in the following two ways.

Remove the cover in the reverse step of installing the cover. Do not install or remove the cover forcefully, or it will cause failure.

[Installation A]

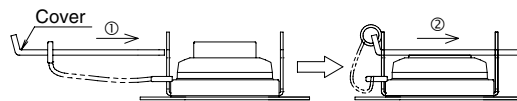

[Installation B]

This method is effective when the neighboring control unit interferes when installing in method A.

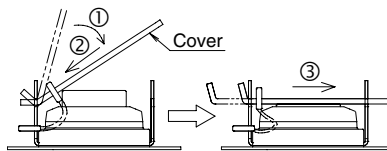

Installing EU9Z-DB Rubber Boots

To install the rubber boot on flush and extended pushbuttons, place the rubber boot on the cap and push the rubber boot holder straight. The notches around the rubber boot must show evenly.

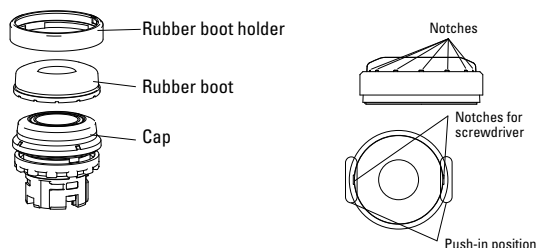

Push the rubber boot holder further around on the two notches on the holder so that the holder fits the button completely.

Make sure that the rubber boot and rubber boot holder are installed straight.

On Nameplate Types, the EU2B and the rubber boot holder must be aligned so that when installed, the anti-rotation projection on the EU2B comes to the center of the groove on the holder.

Make sure that the rubber boot is installed completely, otherwise water droplets might enter the rubber boot, but no water will enter the control box.

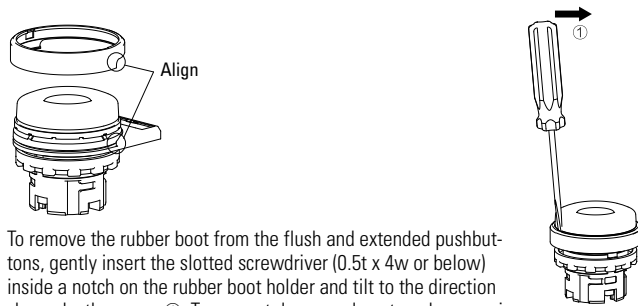

To remove the rubber boot from the flush and extended pushbuttons, gently insert the slotted screwdriver (0.5t x 4w or below) inside a notch on the rubber boot holder and tilt to the direction shown by the arrow ①. To prevent damage, do not apply excessive force to the EU2B when removing the rubber boot.

Maintenance and Inspection

EU2B switches should be installed in an appropriate control box.

Maintenance and Inspection Method

Perform daily or periodical maintenance and inspection for items such as damage and temperature rise of the EU2B switches listed in the Maintenance and Inspection table below.

Observe laws and regulations set by each country. Do not open the lid when inspecting the EC2B while it is energized. Never disassemble the control box. Do not use tools that cause sparks during maintenance and inspection. When using measuring devices, use explosion-protected types. When the EC2B needs to be disassembled or assembled for maintenance or repair, contact IDEC.

Maintenance and Inspection

Inspection Items	Inspection Method	Inspections	Measures
Enclosure base	Visual	No rusting No damages	Cleaning Rust-resistant treatment
Tightening bolt, screws	Visual, tactile	No loosening No rusting	Tightening Cleaning
Packings	Visual	No cracks No apparent deformation	Replacement
Connecting parts	Visual, tactile	No loosening of screws No dirt on insulation materials	Tightening Cleaning
Temperature rise	Thermometer, tactile	Surface temperature 80°C max.	Investigate the cause

Disposal

Observe laws and regulations set by each country concerning refuse disposal.

Safety Precautions

EU2B Control Units

Use EU2B switches that are applicable for use in hazardous areas (potentially explosive atmosphere where explosive gas or vapor may exist), otherwise explosion or fire hazard may result.

- EU2B switches can be installed only in zones 1 and 2. Do not use in zone 0.
- Turn power off to the EU2B switches before installation, removal, wiring, or maintenance, otherwise explosion, fire hazard, or electric shock may result.
- Do not disassemble, repair, or modify, otherwise damage or accident may result.
- Do not use damaged EU2B switches, otherwise damage or accident may result.
- When connecting external devices, make sure that each cable is connected to the correct terminal, otherwise electric shock, fire hazard, or explosion may result.
- Use wires of a proper size to meet voltage and current requirements. Incorrect wiring may cause abnormal temperature rise and lead to fire hazard and explosion.
- Connect the grounding terminal to a proper ground, otherwise electric shock, fire hazard, or explosion may result.
- Operate the EU2B switches at the rated current and voltage specified in this catalog, otherwise short-circuiting, fire hazard, or explosion may result.
- Stop operation immediately if abnormal operation occurs. Otherwise, a secondary accident may occur.
- Use explosion-proof electrical equipment that are applicable for use in hazardous areas (potentially explosive atmosphere where explosive gas or vapor may exist), otherwise explosion or fire hazard may result.

EC2B Control Boxes

- EC2B control boxes can be installed only in zones 1 and 2. Do not use in zone 0. In North America, the EC2B can be installed in Division 2 areas, but cannot be installed in Division 1 areas.
- Turn power off to the EC2B control box before installation, removal, wiring, or maintenance, otherwise explosion, fire hazard, or electric shock may result.
- Special skills and knowledge of explosion protection, electric system installation, and relevant laws/regulations are required to transport, install, wire, operate, repair, and inspect the EC2B control box. People without such expertise must not use the EC2B control box, otherwise damage or accident may result.
- Do not modify the EC2B, otherwise damage or accident may result.
- Do not use a damaged EC2B control box, otherwise damage or accident may result.
- When connecting external devices, make sure that each cable is connected to the correct terminal, otherwise electric shock, fire hazard, or explosion may result.
- Use wires of a proper size to meet voltage and current requirements. Incorrect wiring may cause abnormal temperature rise and lead to fire hazard and explosion.
- Connect the grounding terminal to a proper ground, otherwise electric shock, fire hazard, or explosion may result.
- Do not sit on or hang from the EC2B control box, otherwise damage, personal injury, or accident may result.
- Do not open the lid of the EC2B control box when it is energized, otherwise electric shock, fire hazard, or explosion may result.
- Operate the EC2B control box at the rated current and voltage specified in this catalog, otherwise short-circuiting, fire hazard, or explosion may result.
- When measuring the insulation resistance of the EC2B control box, make sure that potentially explosive atmosphere of explosive gas or vapor does not exist in the vicinity, otherwise explosion may result. Also, do not touch the terminals without paying attention, otherwise electric shock will result.
- Do not place any obstacles in front of the nameplate.
- Do not remove the nameplate.
- When opening the lid for wiring, maintenance or inspection, make sure that substances such as dust, concrete powder, or metal powder do not enter inside the box, otherwise contact failure or insulation failure may result.
- Do not drop the EC2B control box during transportation.
- Be sure to open the carton the right way up, otherwise damage or personal injury may result.
- Check that the product is what you have ordered. Using an incorrect model might result in malfunction or accident.
- Stop operation immediately if abnormal operation occurs. Otherwise, a secondary accident may occur.
- The surface temperature of the EC2B control box may become extremely hot during operation. Before maintenance or inspection of the EC2B, be sure to wear gloves to prevent burning your hand.

TO: IDEC Corporation

Company: _____

TEL: _____

No. of Control Box



Contact Person: _____

FAX: _____

Select the required specifications by checking the checkboxes, and specify the details.

Control box size

EC2B-110

EC2B-210

EC2B-310

EC2B-410

EC2B-510

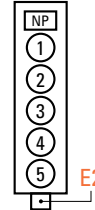
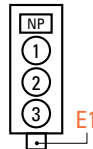
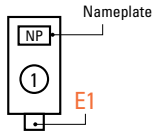

Nameplate (NP)

Material: Acrylic (53 mm × 12 mm, plate thickness 2 mm)
 Legend color: black letter, white background
 Maximum no. of letters: 19 letters per line (up to 2 lines)

No nameplate

1 line

2 lines

1st line	
2nd line	

Control Units

Position	Control Unit Part No.	Control Unit Nameplate
①		<input type="checkbox"/> ON <input type="checkbox"/> OFF <input type="checkbox"/> START <input type="checkbox"/> STOP <input type="checkbox"/> EMERGENCY STOP <input type="checkbox"/> OFF ON <input type="checkbox"/> HAND AUTO <input type="checkbox"/> HAND OFF AUTO <input type="checkbox"/> Blank <input type="checkbox"/> No nameplate <input type="checkbox"/> Specify letters ()
②		<input type="checkbox"/> ON <input type="checkbox"/> OFF <input type="checkbox"/> START <input type="checkbox"/> STOP <input type="checkbox"/> EMERGENCY STOP <input type="checkbox"/> OFF ON <input type="checkbox"/> HAND AUTO <input type="checkbox"/> HAND OFF AUTO <input type="checkbox"/> Blank <input type="checkbox"/> No nameplate <input type="checkbox"/> Specify letters ()
③		<input type="checkbox"/> ON <input type="checkbox"/> OFF <input type="checkbox"/> START <input type="checkbox"/> STOP <input type="checkbox"/> EMERGENCY STOP <input type="checkbox"/> OFF ON <input type="checkbox"/> HAND AUTO <input type="checkbox"/> HAND OFF AUTO <input type="checkbox"/> Blank <input type="checkbox"/> No nameplate <input type="checkbox"/> Specify letters ()
④		<input type="checkbox"/> ON <input type="checkbox"/> OFF <input type="checkbox"/> START <input type="checkbox"/> STOP <input type="checkbox"/> EMERGENCY STOP <input type="checkbox"/> OFF ON <input type="checkbox"/> HAND AUTO <input type="checkbox"/> HAND OFF AUTO <input type="checkbox"/> Blank <input type="checkbox"/> No nameplate <input type="checkbox"/> Specify letters ()
⑤		<input type="checkbox"/> ON <input type="checkbox"/> OFF <input type="checkbox"/> START <input type="checkbox"/> STOP <input type="checkbox"/> EMERGENCY STOP <input type="checkbox"/> OFF ON <input type="checkbox"/> HAND AUTO <input type="checkbox"/> HAND OFF AUTO <input type="checkbox"/> Blank <input type="checkbox"/> No nameplate <input type="checkbox"/> Specify letters ()

Lead-in Fitting (E1/E2)

Without specification
(standard reducer)

With specification

		EC2B-110, 210, 310		EC2B-410, 510			
		UL/c-UL, IECEx/ATEX certified		NPT 3/4			
		NPT 3/4		NPT 1			
		EC2B-110, 210, 310		EC2B-410, 510			
Code	Cable lead-in method	Check	Specification	Code	Cable lead-in method		
E1	Reducer	<input type="checkbox"/>	M16	E2	Reducer	<input type="checkbox"/>	M25
		<input type="checkbox"/>	M20			<input type="checkbox"/>	M32
		<input type="checkbox"/>	M25			<input type="checkbox"/>	M40
		<input type="checkbox"/>	M32			<input type="checkbox"/>	NPT 3/4
		<input type="checkbox"/>	NPT 1/2			<input type="checkbox"/>	NPT 1
		<input type="checkbox"/>	NPT 3/4			<input type="checkbox"/>	NPT 1 1/4
		<input type="checkbox"/>	NPT 1			<input type="checkbox"/>	

• Specify wiring diagram when wiring is required.

• Specify when other accessories are required.