

Piezo Switches

Product Description

Designed for demanding applications where reliability is critical, Piezo switches are based on solid-state outputs allowing for an exceptionally long lifespan. The flat metal surface is completely closed, preventing ingress of liquids and other contaminants, and is perfect for surface cleaning, required in medical and food processing industries. High performance sealing up to IP68 and IP69K is achieved with the single piece construction of the switch.

The Piezo switch series includes a choice of 22mm or 30mm diameter housings with ring or dot illumination, various LED color options (including dual color).

Key features:

- 22 or 30mm diameter stainless steel 316L housing
- Sealing up to IP68 & IP69K (switches mounted on panel)
- Flush mount bezel
- Easy to clean metal surface
- Solid state switch, no moving parts
- Over 50 million lifecycles
- Dot or ring illumination options
- Side viewable illumination models
- Single or dual illumination color
- Short uni-body construction



PW1L-R6AFB002
22mm with LED dot & finger guide



PW1L-RYAFB002
22mm chamfer with LED ring



PN1L-M2AFB002
30mm flush with LED ring



PN1L-M4AFB002
30mm with side-viewable LED ring

Specifications

PART NUMBER		PW1L-R6AFB002 ①②	PW1L-RYAFB002 ①②	PN1L-M2AFB002 ①②	PN1L-M4AFB002 ①②
Construction		Momentary, solid state pushbutton, dot LED indicator, 3mm mount bezel with finger guide	Momentary, solid state pushbutton, LED ring illumination, 4.5mm chamfered bezel	Momentary, solid state pushbutton, LED ring illumination, 2.5mm flush mount bezel	Momentary, solid state pushbutton, LED side-viewable ring illumination, 5.5mm mount bezel
Housing diameter		22mm	22mm	30mm	30mm
MATERIALS	Housing	Stainless steel 316L	Stainless steel 316L	Stainless steel 316L	Stainless steel 316L
	Wire sealing	Epoxy	Epoxy	Epoxy	Epoxy
	Illuminated ring		Polycarbonate (translucent when off)	Polycarbonate (translucent when off)	Polycarbonate (translucent when off)
	Locking nut	Stainless steel	Stainless steel	PA6.6 nylon - black	PA6.6 nylon - black
ELECTRICAL	Switch effect	Pulse once activated (pulse duration depending on actuation force and speed)			
	Electrical function	1 Normally Open (NO) contact			
	Maximum ratings	1A@ 24V AC or DC			
	Electrical life	50 million cycles			
	Switch resistance ON / OFF	ON: 10 ohms max / OFF: 5 M ohms min			
	LED consumption	10mA @ 12VDC or 24VDC			20mA @ 12VDC or 24VDC
	Insulation resistance	1000 Mohms minimum at 500VDC			
	Dielectric strength	500 Vrms 50Hz min between outputs and housing			
MECHANICAL	Torque	2.5Nm (1.8lb-ft) min - 3.0Nm (2.2lb-ft) max applied to locking nut		1.5Nm (1.1lb-ft) min - 10.0Nm (7.4lb-ft) max applied to locking nut	
	Operating force	2.00N (0.45lb) - 6.00N (1.35lb)		6.00N (1.35lb) - 12.00N (2.70lb)	
	Panel thickness	1.5mm min to 6.5mm max		1.5mm min to 6mm max	
Temperature range		-40°C to +75°C (-40°F to +167°F)			
Sealing		IP68 according to IEC 60529; IP69K according to DIN 40050-9			
Vibration resistance		10-500Hz / 10g per IEC 60068-2-6			
EMC		EN61000-4 & EN61000-6-2			

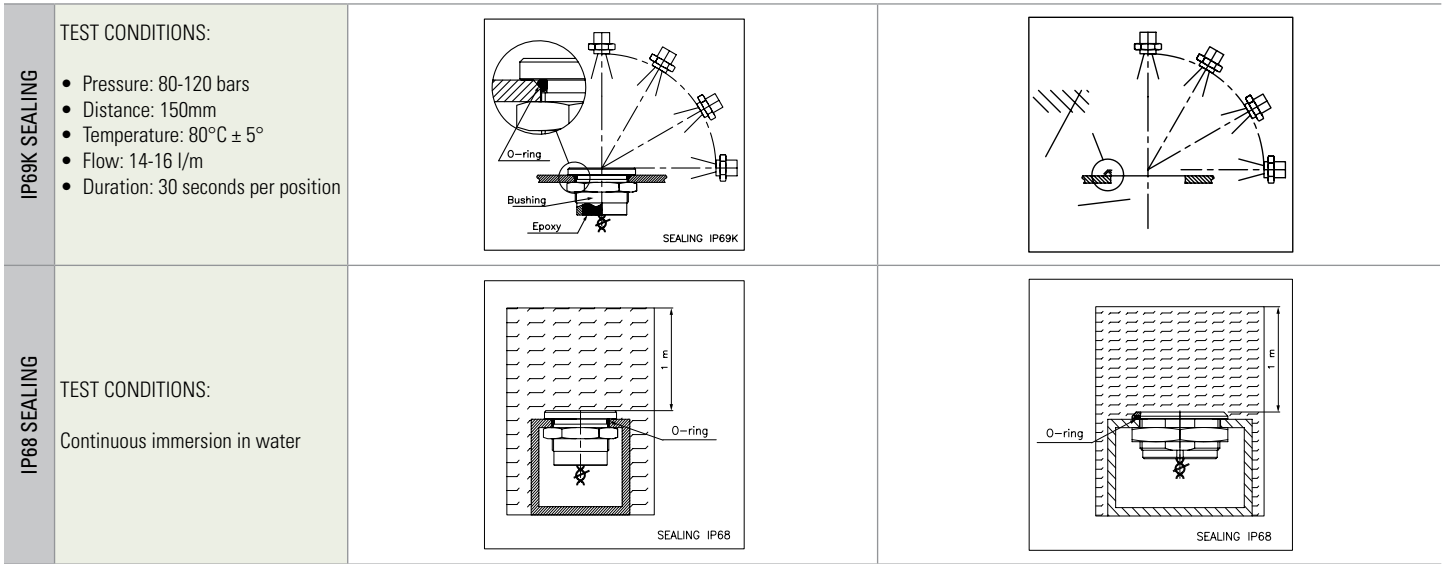

Part Numbers

Part Number	Description	Panel cut size	LED voltage ①	LED color ②
PW1L-R6AFB002①②	22mm Piezo switch with LED dot & finger guide	Ø22mm	P: Dot / 12VDC J: Dot / 24VDC	OB: Blue OG: Green OS: Red OY: Yellow OW: White SG: Red/Green ¹
PW1L-RYAFB002①②	22mm Piezo switch with LED ring	Ø22mm	D: Ring / 12VDC E: Ring / 24VDC	OB: Blue OG: Green OS: Red OY: Yellow OW: White 2A: Red/Green ²
PN1L-M2AFB002①②	30mm flush Piezo switch with LED ring	Ø30mm	D: Ring / 12VDC E: Ring / 24VDC	OB: Blue OG: Green OS: Red OY: Yellow OW: White 2A: Red/Green ²
PN1L-M4AFB002①②	30mm Piezo switch with side viewable LED ring	Ø30mm	D: Ring / 12VDC E: Ring / 24VDC	OB: Blue OG: Green OS: Red OY: Yellow OW: White 2A: Red/Green ²

Replacement Parts

Part Number	Description	Size	Material
PW9Z-LNM	Spare 22mm Piezo Switch Hex Locking Nut	M22x1	Metal
PN9Z-LN	Spare 30mm Piezo Switch Hex Locking Nut	M30x1.5	Plastic

Note:
 1. See Equivalent Circuit Diagram-2 on page 837 for details.
 2. See Equivalent Circuit Diagram-4 on page 837 & 838 for details.

PIEZO SWITCH PW1L-R6AFB002

PANEL CUT OUT

All dimensions in mm

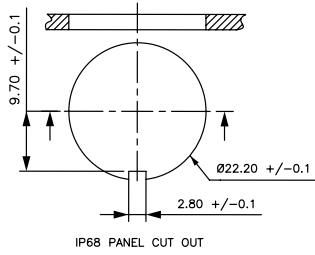

IP68 PANEL CUT OUT

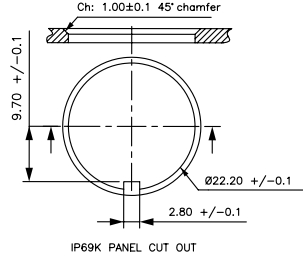

IP69K PANEL CUT OUT

DIMENSIONS

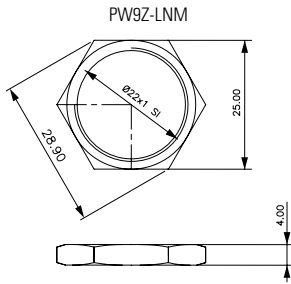
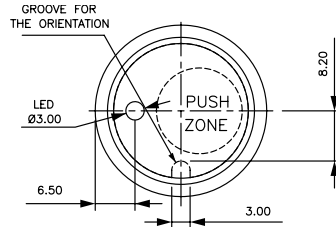
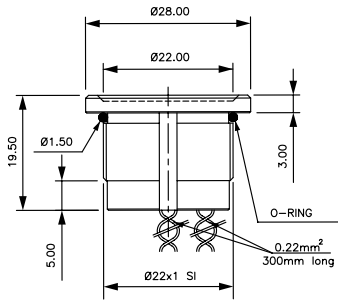

PW9Z-LNM

PIEZO SWITCH PW1L-RYAFB002

PANEL CUT OUT

All dimensions in mm

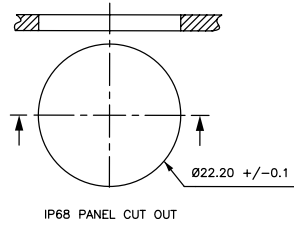

IP68 PANEL CUT OUT

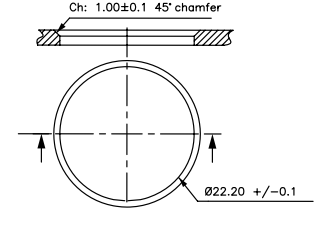

IP69K PANEL CUT OUT

DIMENSIONS

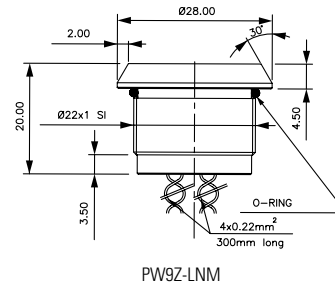

PW9Z-LNM

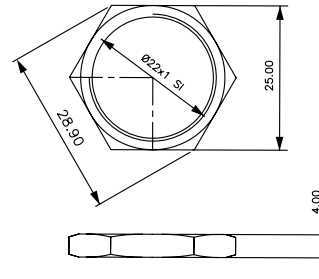
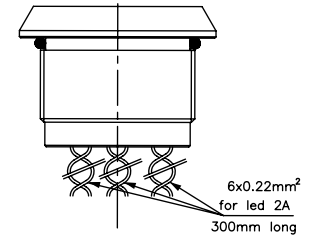

PW1L-RYAFB002

PW1L-R6AFB002

Type of Illumination-Voltage	
P	DOT - 12V
J	DOT - 24V

LED COLORS	DIAGRAM TYP.
OB BLUE	1
OG GREEN	1
OS RED	1
OY YELLOW	1
OW WHITE	1
SG RED/GREEN	2

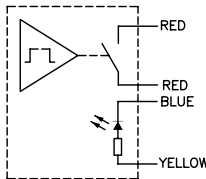

EQUIVALENT CIRCUIT DIAGRAM-1

LED COLOR	RED WIRES	N.O. CONTACT Max.rating: 1A 24V AC/DC
RED	YELLOW WIRE	LED +12V DC or +24V DC
GREEN	BLUE WIRE	LED GND

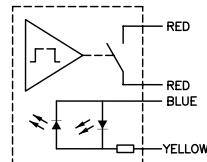

EQUIVALENT CIRCUIT DIAGRAM-2

LED COLOR	RED WIRES	N.O. CONTACT Max.rating: 1A 24V AC/DC
RED	YELLOW WIRE	LED +12V DC or +24V DC
GREEN	BLUE WIRE	LED GND
RED	YELLOW WIRE	LED GND
GREEN	BLUE WIRE	LED +12V DC or +24V DC

Type of Illumination-Voltage	
D	Thin ring 12V
E	Thin ring 24V

LED COLORS	DIAGRAM TYP.
OB BLUE	1
OG GREEN	1
OS RED	1
OY YELLOW	1
OW WHITE	1
2A RED/GREEN	2

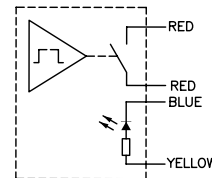

EQUIVALENT CIRCUIT DIAGRAM-3

LED COLOR	RED WIRES	N.O. CONTACT Max.rating: 1A 24V AC/DC
RED	YELLOW WIRE	LED +12V DC or +24V DC
GREEN	BLUE WIRE	LED GND

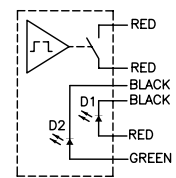

EQUIVALENT CIRCUIT DIAGRAM-4

LED COLOR	RED WIRES	N.O. CONTACT Max.rating: 1A 24V AC/DC
RED	GREEN WIRE	LED +12V DC or +24V DC
GREEN	BLACK WIRE	LED GND
RED	BLACK WIRE	LED GND
GREEN	RED WIRE	LED +12V DC or +24V DC

PIEZO SWITCH PN1L-M2AFB002

PANEL CUT OUT

All dimensions in mm

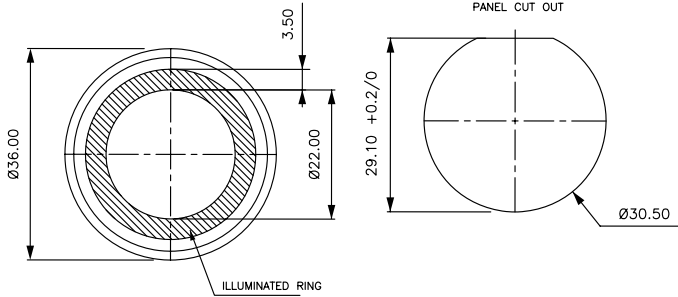

DIMENSIONS

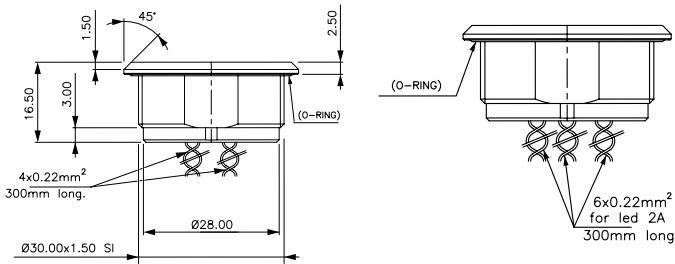

PN9Z-LN

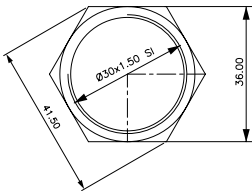

PIEZO SWITCH PN1L-M4AFB002

PANEL CUT OUT

All dimensions in mm

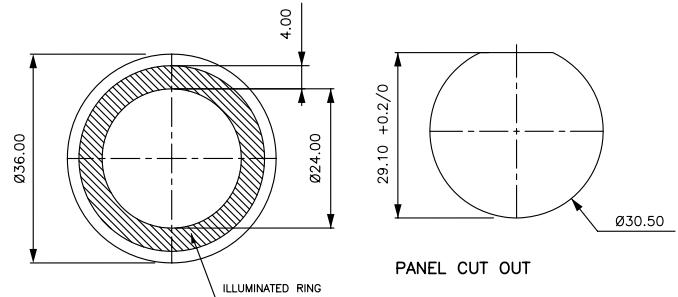

DIMENSIONS

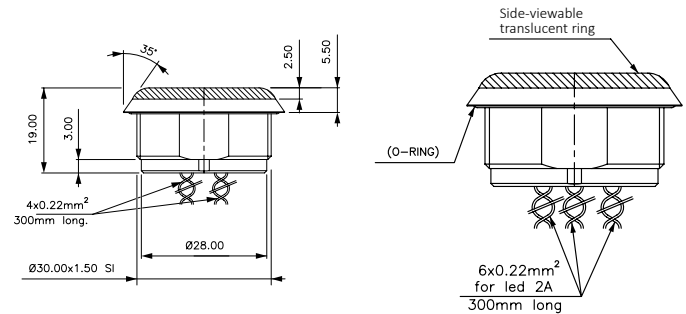

PN9Z-LN

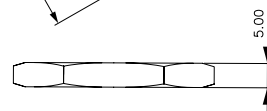
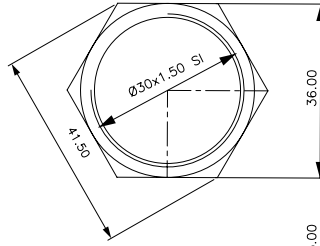

PN1L-M2AFB002

Type of Illumination-Voltage	
D	12V
E	24V

LED COLORS	DIAGRAM TYP.
OB BLUE	1
OG GREEN	1
OS RED	1
OY YELLOW	1
OW WHITE	1
2A RED/GREEN	2

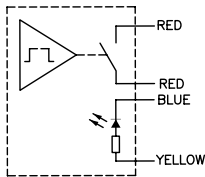

EQUIVALENT CIRCUIT DIAGRAM-1

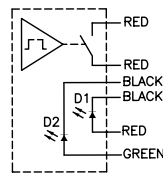

EQUIVALENT CIRCUIT DIAGRAM-2

RED WIRES	N.O. CONTACT Max.rating: 1A 24V AC/DC
YELLOW WIRE	LED +12V DC or +24V DC
BLUE WIRE	LED GND

LED COLOR	LED COLOR	N.O. CONTACT Max.rating: 1A 24V AC/DC
D1-RED	D2-GREEN	LED +12V DC or +24V DC
BLACK WIRE		LED GND
BLACK WIRE		LED GND
RED WIRE		LED +12V DC or +24V DC

PN1L-M4AFB002

Type of Illumination-Voltage	
D	12V
E	24V

LED COLORS	DIAGRAM TYP.
OB BLUE	1
OG GREEN	1
OS RED	1
OY YELLOW	1
OW WHITE	1
2A RED/GREEN	2

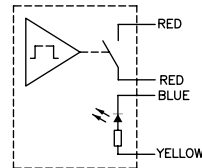

EQUIVALENT CIRCUIT DIAGRAM-3

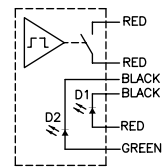

EQUIVALENT CIRCUIT DIAGRAM-4

RED WIRES	N.O. CONTACT Max.rating: 1A 24V AC/DC
YELLOW WIRE	LED +12V DC or +24V DC
BLUE WIRE	LED GND

LED COLOR	LED COLOR	N.O. CONTACT Max.rating: 1A 24V AC/DC
D1-RED	D2-GREEN	LED +12V DC or +24V DC
BLACK WIRE		LED GND
BLACK WIRE		LED GND
RED WIRE		LED +12V DC or +24V DC