

6mm and 14mm Slim Interface Relay

Key features:

- Class I, Division 2 and Class I, Zone 2 Hazardous Location options (electromechanical relays only)
- Solid State relay versions available (6mm only)
- Only 70mm in height from DIN rail
- Gold-plated contacts (electrical mechanical relays only)
- Pre-assembled relay and DIN mount socket
- Universal screw terminals (flat and phillips) or spring clamp terminals
- Universal AC/DC socket with built-in surge suppression and green LED
- 6A-16A contact rating (electromechanical relays only)
- Lever for easy locking and removal of relay
- Operating temperature of -40°C ~ +70°C (-20°C ~ +60°C for SSR)
- RoHS compliant



Electromechanical Screw Terminal



6mm wide

Solid State Spring Clamp Terminal



6mm wide

General Specifications

	Electromechanical Standard/ Hazardous Location C1D2	Solid State
Ratings	Class I, Division 2, Groups A, B, C, D, T4A Class I, Zone 2 AEx nA nC IIC T4 Class I, Zone 2 Ex nA nC IIC T4 X Gc UL/c-UL Listed CE	UL/c-UL Listed, CE
Number of Poles	1 Pole	1 Pole
Contact Configuration	1C (SPDT)	1A (SPST)
Contact Material	AgNi (Au plating)	MOSFET, Transistor or Triac
Degree of Protection	IP20	IP20
Dielectric Strength	Between Contact and Coil	4,000V AC for 1 minute
	Between Pole	1,000V AC for 1 minute
Vibration Resistance	Operating Extremes	Frequency 10 to 55Hz, Amplitude 0.5mm (NO contact), 0.2mm (NC contact)
	Damage Limits	-
Shock Resistance	Operating Extremes	NO: 49m/s ² NC: 29.4m/s ²
	Damage Limits	980m/s ²
Mechanical Life (no load)	Over 10,000,000 operations (operation frequency 18,000 operations per hour)	-
Operating Temperature	-40 to +70°C no freezing (-40 to +55°C for AD110 and AD220 coil voltages)	-20 to +60°C
Operating Humidity	5 to 85% (no condensation)	5 to 85% (no condensation)
Weight (approx.)	Screw Terminal: 30g, Spring Clamp Terminal: 26g	Screw Terminal: 30g, Spring Clamp Terminal: 26g

Switches & Pilot Lights

Signaling Lights

Relays & Sockets

Timers

Contactors

Terminal Blocks

Circuit Breakers

RV8 Series 14mm Width

Top View with Marking Plate



Screw Terminal

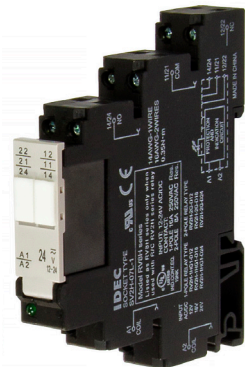

Spring Clamp Terminal

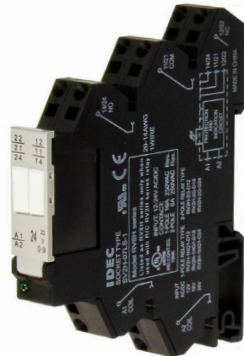

Key features:

- Class I, Division 2 and Class I, Zone 2 Hazardous Location options
- Space-saving 14mm width.
- Universal AC/DC socket with surge suppression and green LED Indicator
- Gold plated contacts (2-pole model only)
- Pre-assembled relay and DIN mount socket
- Universal screw terminals (flat and Philips) or spring clamp terminals
- Only 70 mm in height from DIN rail
- Release lever for easy locking and removal of relay
- Wide input voltage range: 6 to 240V
- High dielectric strength and impulse withstand voltages.
- Reverse polarity protected
- RoHS compliant

Specifications

Number of Poles		1 Pole	2 Pole
Ratings		Class I, Division 2, Groups A, B, C, D, T4 Class I, Zone 2 AEx nA nC IIC T4 Class I, Zone 2 Ex nA nC IIC T4 X Gc UL/c-UL Listed CE	
Contact Configuration		1C (SPDT)	2C (DPDT)
Contact Material		AgNi	AgNi (Au-plated)
Degree of Protection		IP20	IP20
Dielectric strength	Between contact and coil	5,000V AC for 1 minute	
	Between contacts of the same pole	1,000V AC for 1 minute	
	Between contact sets	-	2,500V AC for 1 minute
Vibration Resistance	Operating extremes	Frequency 10 to 55Hz, Amplitude 0.75mm (NO contact), 0.175mm (NC contact)	
	Damage limits	Frequency 10 to 55Hz, Amplitude 0.75mm (NO contact), 0.1mm (NC contact)	
Shock Resistance	Operating extremes	NO: 98m/s ² NC: 24.5m/s ²	
	Damage limits	980m/s ²	
Electrical Life - Screw terminal		AC load:30,000 operations minimum (250V AC, 16A resistive load, operation frequency 360 operation per hour)	AC load:100,000 operations minimum (250V AC, 8A resistive load, operation frequency 360 operation per hour)
Electrical Life - Spring Clamp terminal		AC load:30,000 operations minimum (250V AC, 12A resistive load, operation frequency 360 operation per hour)	AC load:100,000 operations minimum (250V AC, 6A resistive load, operation frequency 360 operation per hour)
Mechanical Life (no load)		Over 10,000,000 operations (Operation frequency 18,000 operations per hour)	Over 10,000,000 operations (Operation frequency 18,000 operations per hour)
Operating Temperature	RV8H-1L1-D6, D9, D12, D18, D24, AD12, AD18, AD24, AD48, AD60, AD110 : -40 to +70°C (Contact current 12A max, 6A per terminal) no freezing : -40 to +55°C (Contact current 16A max, 8A per terminal) no freezing	RV8H-2L-D6, D9, D12, D18, D24, AD12, AD18, AD24, AD48, AD60, AD110 : -40 to +70°C (Contact current 6A max) no freezing : -40 to +55°C (Contact current 8A max) no freezing	
	RV8H-1L1- AD220 : -40 to +55°C (Contact current 16A max, 8A per terminal) no freezing	RV8H-2L- AD220 : -40 to +55°C (Contact current 8A max) no freezing	
	RV8H-1S1-D6, D9, D12, D18, D24, AD12, AD18, AD24, AD48, AD60, AD110 : -40 to +70°C (Contact current 12A max, 6A per terminal) no freezing	RV8H-2S-D6, D9, D12, D18, D24, AD12, AD18, AD24, AD48, AD60, AD110 : -40 to +70°C (Contact current 6A max) no freezing	
	RV8H-1S1- AD220 : -40 to +55°C (Contact current 12A max, 6A per terminal) no freezing	RV8H-2S- AD220 : -40 to +55°C (Contact current 6A max) no freezing	
Operating Humidity		5 to 85% (no condensation)	
Weight (approx.)		Screw Terminal: 52g Spring Clamp Terminal: 49g	Screw Terminal: 52g Spring Clamp Terminal: 49g

Switches & Pilot Lights

Signaling Lights

Relays & Sockets

Timers

Contactors

Terminal Blocks

Circuit Breakers

Part Numbers

6mm Electromechanical Relay

		Screw Terminal	Spring Clamp Terminal
--	--	----------------	-----------------------



	Input Voltage	General Purpose	Hazardous Location (C1D2)	General Purpose	Hazardous Location (C1D2)
DC	6V	RV8H-L-D6	RV8H-L-D6-C1D2	RV8H-S-D6z	RV8H-S-D6-C1D2
	9V	RV8H-L-D9	RV8H-L-D9-C1D2	RV8H-S-D9	RV8H-S-D9-C1D2
	12V	RV8H-L-D12	RV8H-L-D12-C1D2	RV8H-S-D12	RV8H-S-D12-C1D2
	18V	RV8H-L-D18	RV8H-L-D18-C1D2	RV8H-S-D18	RV8H-S-D18-C1D2
	24V	RV8H-L-D24	RV8H-L-D24-C1D2	RV8H-S-D24	RV8H-S-D24-C1D2
AC/DC	12V	RV8H-L-AD12	RV8H-L-AD12-C1D2	RV8H-S-AD12	RV8H-S-AD12-C1D2
	18V	RV8H-L-AD18	RV8H-L-AD18-C1D2	RV8H-S-AD18	RV8H-S-AD18-C1D2
	24V	RV8H-L-AD24	RV8H-L-AD24-C1D2	RV8H-S-AD24	RV8H-S-AD24-C1D2
	48V	RV8H-L-AD48	RV8H-L-AD48-C1D2	RV8H-S-AD48	RV8H-S-AD48-C1D2
	60V	RV8H-L-AD60	RV8H-L-AD60-C1D2	RV8H-S-AD60	RV8H-S-AD60-C1D2
	110V - 125V	RV8H-L-AD110	RV8H-L-AD110-C1D2	RV8H-S-AD110	RV8H-S-AD110-C1D2
	220V - 240V	RV8H-L-AD220	RV8H-L-AD220-C1D2	RV8H-S-AD220	RV8H-S-AD220-C1D2

6mm Solid State Relay

		Screw Terminal	Spring Clamp Terminal
--	--	----------------	-----------------------



	Input Voltage	Output Voltage	Part Number	Part Number
DC	6V	24V DC, 3.5A	RV8S-L-D24-D6	RV8S-S-D24-D6
		48V DC, 0.1A	RV8S-L-D48-D6	RV8S-S-D48-D6
		240V AC, 2A zero cross	RV8S-L-A240Z-D6	RV8S-S-A240Z-D6
		240V AC, 2A random	RV8S-L-A240-D6	RV8S-S-A240-D6
	24V	24V DC, 3.5A	RV8S-L-D24-D24	RV8S-S-D24-D24
		48V DC, 0.1A	RV8S-L-D48-D24	RV8S-S-D48-D24
		240V AC, 2A zero cross	RV8S-L-A240Z-D24	RV8S-S-A240Z-D24
		240V AC, 2A random	RV8S-L-A240-D24	RV8S-S-A240-D24
AC	120V	24V DC, 3.5A	RV8S-L-D24-A120	RV8S-S-D24-A120
		48V DC, 0.1A	RV8S-L-D48-A120	RV8S-S-D48-A120
		240V AC, 2A zero cross	RV8S-L-A240Z-A120	RV8S-S-A240Z-A120
		240V AC, 2A random	RV8S-L-A240-A120	RV8S-S-A240-A120
	240V	24V DC, 3.5A	RV8S-L-D24-A240	RV8S-S-D24-A240
		48V DC, 0.1A	RV8S-L-D48-A240	RV8S-S-D48-A240
		240V AC, 2A zero cross	RV8S-L-A240Z-A240	RV8S-S-A240Z-A240
		240V AC, 2A random	RV8S-L-A240-A240	RV8S-S-A240-A240

14 mm Electromechanical Relay

		Screw Terminal				Spring Clamp Terminal			
--	--	----------------	--	--	--	-----------------------	--	--	--



Input voltage	General Purpose		Hazardous Location (C1D2)		General Purpose		Hazardous Location (C1D2)		
	1 Pole	2 Pole	1 Pole	2 Pole	1 Pole	2 Pole	1 Pole	2 Pole	
DC	6V	RV8H-1L1-D6	RV8H-2L-D6	RV8H-1L1-D6-C1D2	RV8H-2L-D6-C1D2	RV8H-1S1-D6	RV8H-2S-D6	RV8H-1S1-D6-C1D2	RV8H-2S-D6-C1D2
	9V	RV8H-1L1-D9	RV8H-2L-D9	RV8H-1L1-D9-C1D2	RV8H-2L-D9-C1D2	RV8H-1S1-D9	RV8H-2S-D9	RV8H-1S1-D9-C1D2	RV8H-2S-D9-C1D2
	12V	RV8H-1L1-D12	RV8H-2L-D12	RV8H-1L1-D12-C1D2	RV8H-2L-D12-C1D2	RV8H-1S1-D12	RV8H-2S-D12	RV8H-1S1-D12-C1D2	RV8H-2S-D12-C1D2
	18V	RV8H-1L1-D18	RV8H-2L-D18	RV8H-1L1-D18-C1D2	RV8H-2L-D18-C1D2	RV8H-1S1-D18	RV8H-2S-D18	RV8H-1S1-D18-C1D2	RV8H-2S-D18-C1D2
	24V	RV8H-1L1-D24	RV8H-2L-D24	RV8H-1L1-D24-C1D2	RV8H-2L-D24-C1D2	RV8H-1S1-D24	RV8H-2S-D24	RV8H-1S1-D24-C1D2	RV8H-2S-D24-C1D2
AC/DC	12V	RV8H-1L1-AD12	RV8H-2L-AD12	RV8H-1L1-AD12-C1D2	RV8H-2L-AD12-C1D2	RV8H-1S1-AD12	RV8H-2S-AD12	RV8H-1S1-AD12-C1D2	RV8H-2S-AD12-C1D2
	18V	RV8H-1L1-AD18	RV8H-2L-AD18	RV8H-1L1-AD18-C1D2	RV8H-2L-AD18-C1D2	RV8H-1S1-AD18	RV8H-2S-AD18	RV8H-1S1-AD18-C1D2	RV8H-2S-AD18-C1D2
	24V	RV8H-1L1-AD24	RV8H-2L-AD24	RV8H-1L1-AD24-C1D2	RV8H-2L-AD24-C1D2	RV8H-1S1-AD24	RV8H-2S-AD24	RV8H-1S1-AD24-C1D2	RV8H-2S-AD24-C1D2
	48V	RV8H-1L1-AD48	RV8H-2L-AD48	RV8H-1L1-AD48-C1D2	RV8H-2L-AD48-C1D2	RV8H-1S1-AD48	RV8H-2S-AD48	RV8H-1S1-AD48-C1D2	RV8H-2S-AD48-C1D2
	60V	RV8H-1L1-AD60	RV8H-2L-AD60	RV8H-1L1-AD60-C1D2	RV8H-2L-AD60-C1D2	RV8H-1S1-AD60	RV8H-2S-AD60	RV8H-1S1-AD60-C1D2	RV8H-2S-AD60-C1D2
	110V - 125V	RV8H-1L1-AD110	RV8H-2L-AD110	RV8H-1L1-AD110-C1D2	RV8H-2L-AD110-C1D2	RV8H-1S1-AD110	RV8H-2S-AD110	RV8H-1S1-AD110-C1D2	RV8H-2S-AD110-C1D2
	220V - 240V	RV8H-1L1-AD220	RV8H-2L-AD220	RV8H-1L1-AD220-C1D2	RV8H-2L-AD220-C1D2	RV8H-1S1-AD220	RV8H-2S-AD220	RV8H-1S1-AD220-C1D2	RV8H-2S-AD220-C1D2

Switches & Pilot Lights

Signaling Lights

Relays & Sockets

Timers

Contactors

Terminal Blocks

Circuit Breakers

Ratings

6mm Electromechanical Coil Ratings

Rated Voltage	Rated Current ±15% (mA) ¹ (at 23°C)	Circuit AC Resis- tance ±15% (Ω) ¹ (at 23°C)	Circuit DC Resis- tance ±15% (Ω) ¹ (at 23°C)	Operating Characteristics			Power Consumption (W)
				Pickup Voltage (at 23°C)	Dropout Voltage (at 23°C)	Maximum Allowable Voltage (at 23°C)	
DC	6V	35	-	90% max	7% min	110%	0.21
	9V	18.6	-				0.2
	12V	14.6	-				0.2
	18V	11.6	-				0.2
	24V	10.6	-				0.25
AC/ DC	12V	15.5	755	90% max	7% min	110%	0.2
	18V	13.3	1365				0.25
	24V	13.7	1730				0.33
	48V	4	11880				0.2
	60V	3.4	17600				0.2
	110V - 125V	3.4 - 3.9	31790 - 31890				0.5
	220V - 240V	3.3 - 3.6	65670 - 66070				0.85

Note 1 ±10% for 6V, 9V and 12V

6mm Electromechanical Contact Ratings

Allowable Contact Power	Resistive Load	1500VA, 180W DC
Rated Load	Resistive Load	250V AC 6A, 30V DC 6A
Allowable Switching Current		6A
Allowable Switching Voltage		400V AC, 125V DC
Allowable Switching Power		1500VA, 180W DC
Minimum Applicable Load		6V DC/10mA

6mm Solid State Input Ratings

Type	Control Voltage Range	Output / Input Voltage	Pickup Voltage	Dropout Voltage	Input Current	Maximum Operation Time	Maximum Release Time	
Contactors	4.5-12V DC	24V DC / 6V DC	4.5V DC	1.5V DC	10mA±10%(±6VDC)	120µs	200µs	
	19.6-30V DC	24V DC / 24V DC	19.6V DC	5V DC	9mA±10%(±24VDC)	350µs	200µs	
	96-132V AC	24V DC / 120V AC	96V AC	12V AC	10mA±10%(±120VAC)	11ms	14ms	
	192-264V AC	24V DC / 240V AC	192V AC	24V AC	10mA±10%(±240VAC)	11ms	14ms	
	4.5-12V DC	48V DC / 6V DC	4.5V DC	1.5V DC	6mA±10%(±6VDC)	40µs	300µs	
Terminal Blocks	19.6-30V DC	48V DC / 24V DC	19.6V DC	5V DC	7mA±10%(±24VDC)	40µs	300µs	
	96-132V AC	48V DC / 120V AC	96V AC	12V AC	10mA±10%(±120VAC)	8ms	14ms	
	192-264V AC	48V DC / 240V AC	192V AC	24V AC	10mA±10%(±240VAC)	8ms	14ms	
	Zero Crossing	4.5-12V DC	240V AC / 6V DC	4.5V DC	2V DC	15mA±10%(±6VDC)	10ms	10ms
		19.6-30V DC	240V AC / 24V DC	19.6V DC	5V DC	7mA±10%(±24VDC)	10ms	10ms
96-132V AC		240V AC / 120V AC	96V AC	12V AC	10mA±10%(±120VAC)	16ms	20ms	
192-264V AC		240V AC / 240V AC	192V AC	24V AC	10mA±10%(±240VAC)	16ms	20ms	
Random Crossing	4.5-12V DC	240V AC / 6V DC	4.5V DC	2V DC	15mA±10%(±6VDC)	300µs	10ms	
	19.6-30V DC	240V AC / 24V DC	19.6V DC	5V DC	7mA±10%(±24VDC)	300µs	10ms	
	96-132V AC	240V AC / 120V AC	96V AC	12V AC	10mA±10%(±120VAC)	8ms	20ms	
	192-264V AC	240V AC / 240V AC	192V AC	24V AC	10mA±10%(±240VAC)	8ms	20ms	

Switches & Pilot Lights

Signaling Lights

Relays & Sockets

Timers

Contactors

Terminal Blocks

Circuit Breakers

6mm Solid State Output Ratings

Typical Input Voltage	24V DC	48V DC	240V AC
Output Device	MOSFET	Photo-transistor	Triac
Operating Voltage Range	0-24V DC	0-48V DC	24-280V AC (47-63Hz)
Maximum Load Current	3.5A	100mA	2A
Minimum Load Current	1mA	1mA	70mA
Maximum Blocking Voltage	30V DC	60V DC	600V AC
Maximum Surge Current	9A (10ms)	300mA (10ms)	120A pk (16.6ms)
Maximum I ² t for Fusing	–	–	60A ² sec
Typical On-State Leakage Current	0.4V	1V	1.1V (peak)
Maximum Off-State Leakage Current	0.001mA	0.001mA	4mA
Switching Configuration	Normally Open	Normally Open	Normally Open

14mm Electromechanical Coil Ratings

Rated Voltage	Rated Current ±15% (mA) ¹ (at 23°C)			Circuit AC Resistance ±15% (Ω) ¹ (at 23°C)			Operating Characteristics (Against Rated Voltage)				Operation and release time	Power Consumption (W)						
	DC	AC 50Hz	AC 60Hz	DC	AC 50Hz	AC 60Hz	Pickup Voltage (at 23°C)	Dropout Voltage (at 23°C)	Maximum Allowable Voltage (at 23°C)	Maximum Allowable Voltage ²		DC	AC (50Hz)	AC (60Hz)				
DC	6V	75.0		80			80% max	7% min	120%		15ms max	0.45	-	-				
	9V	44.0		205								0.40	-	-				
	12V	32.0		375								0.38	-	-				
	18V	24.0		750								0.43	-	-				
	24V	20.0		1200								0.48	-	-				
AC/DC	12V	32.0	29.0	29.0	375	414							110%			0.38	0.35	0.35
	18V	24.0	24.0	24.0	750	750										0.43	0.43	0.43
	24V	20.0	21.0	21.0	1200	1143										0.48	0.50	0.50
	48V	7.6	9.0	9.0	6316	5333										0.36	0.43	0.43
	60V	7.6	9.0	9.0	7895	6667										0.46	0.54	0.54
	110V - 125V	4.4-5.1	5.3-5.8	5.3-5.8	24510	21552	0.64	0.73		0.73								
	220V - 240V	4-4.6	4.5-5.2	4.8-5.5	52174	46154	1.10	1.25		1.32								

Note 1: Input voltages lower than 24V: ±10%

Note 2: At rated operating temperature

Switches & Pilot Lights

Signaling Lights

Relays & Sockets

Timers

Contactors

Terminal Blocks

Circuit Breakers



14mm Contact Ratings

		Screw Terminal	Spring Clamp Terminal
Allowable contact power	Resistive load	1 Pole 4,000VA 2 Pole 2,000VA	1 Pole 3,000VA 2 Pole 1,500VA
	Inductive load	B300 (pilot duty)	B300 (pilot duty)
Rated Load	Resistive load	1 Pole 250V AC, 16A (8A per terminal) at 55°C, 12A (6A per terminal) at 70°C 2 Pole 250V AC, 8A at 55°C, 6A at 70°C	1 Pole 250V AC, 12A (6A per terminal) at 70°C 2 Pole 250V AC, 6A at 70°C
	Inductive load	B300 (pilot duty)	B300 (pilot duty)
Allowable Switching Current		1 Pole 16A (8A per terminal) at 55°C, 12A (6A per terminal) at 70°C 2 Pole 8A at 55°C, 6A at 70°C	1 Pole 12A (6A per terminal) at 70°C 2 Pole 6A at 70°C
Allowable Switching Power		1 Pole 4,000VA 2 Pole 2,000VA	1 Pole 3,000VA 2 Pole 1,500VA
Minimum Applicable Load (reference value)		1 Pole 6VDC 100mA 2 Pole 5VDC 10mA	1 Pole 6VDC 100mA 2 Pole 5VDC 10mA

Accessories

Jumper, Spacer, and Screwdriver

6mm	Color	Part Number
 <p>Jumper for 6mm Relay (20 combs)^{1, 2, 6}</p>	Black	SV9Z-J20B
	Gray	SV9Z-J20W
	Blue	SV9Z-J20S
14mm		
 <p>Jumper for 14mm Relay (32 combs, with 2 combs per relay, or 16 discrete relays.)^{3, 4, 6}</p>	Black	SV9Z-J232B
	Gray	SV9Z-J232W
	Blue	SV9Z-J232S

<p>Spacer (circuit separator)^{5, 6}</p> 	SV9Z-SA2W
<p>Screwdriver</p> 	BC1S-SD0

1. Jumper combs come with 20 points for 6mm relays. If shorter lengths are needed, simply cut off the excess points.
2. Ensure that the total current to the jumper does not exceed the overall rated current (Rated current: 6A).
3. Jumper combs come with 16 pairs of combs for 14mm relays. If shorter lengths are needed, simply cut off the excess points.
4. Ensure that the total current to the jumper does not exceed the overall rated current (Rated current: 6A for spring-clamp terminals and 8A for screw type terminations).
5. Width of spacer: 2mm
6. When using a cut jumper, please use a spacer on the cut side. For additional information see instruction sheet.

Marking Plate Part Numbers

	6mm	14mm	Part Number	Engraving
Horizontal Orientation			SV9Z-PW10	blank
			SV9Z-PW10-⊙1-10	1-10
			SV9Z-PW10-⊙11-20	11-20
			SV9Z-PW10-⊙21-30	21-30
			SV9Z-PW10-⊙31-40	31-40
			SV9Z-PW10-⊙41-50	41-50
			SV9Z-PW10-⊙51-60	51-60
			SV9Z-PW10-⊙61-70	61-70
			SV9Z-PW10-⊙71-80	71-80
			SV9Z-PW10-⊙81-90	81-90
Vertical Orientation			SV9Z-PW10-⊙91-100	91-100
			SV9Z-PW10-⊙A-J	A-J
			SV9Z-PW10-⊙K-T	K-T
			SV9Z-PW10-⊙U-Z	U-Z
			SV9Z-PW10-⊙GROUND	⊕
			SV9Z-PW10-⊙AC	Ⓜ

1. In place of ⊙ insert orientation code: V=Vertical, H=Horizontal
2. Each unit has 10 pieces (marking plates).

Marking Plate Placement

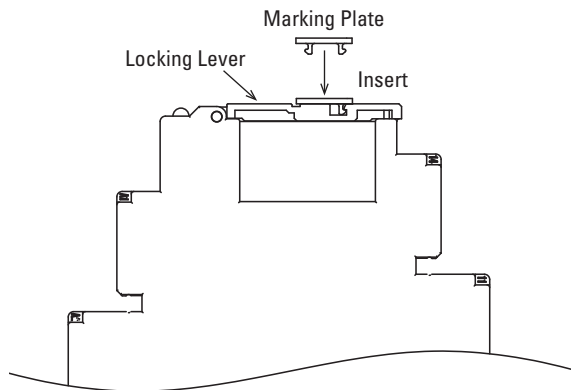

Switches & Pilot Lights
 Signaling Lights
 Relays & Sockets
 Timers
 Contactors
 Terminal Blocks
 Circuit Breakers

Dimensions (mm)

6mm Electromechanical and Solid State Relay
 6mm Screw Terminal

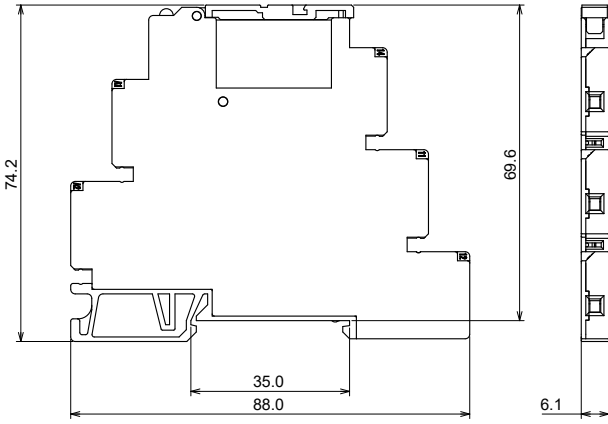

6mm Spring Clamp Terminal

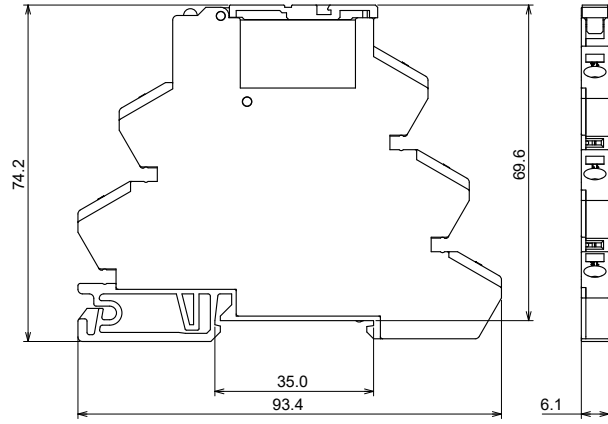

14mm Electromechanical Relay
 14mm Screw Terminal

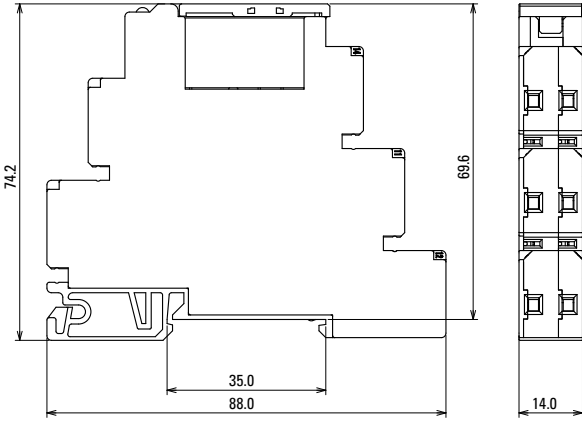

14mm Spring Clamp Terminal

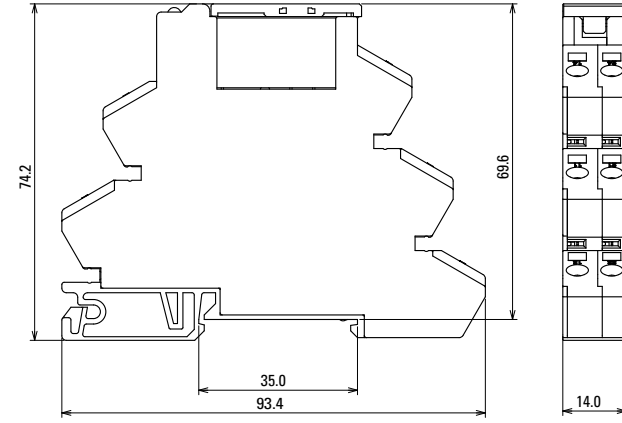

Internal Connections

6mm Electromechanical Relay

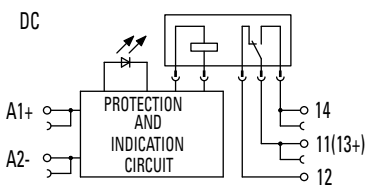
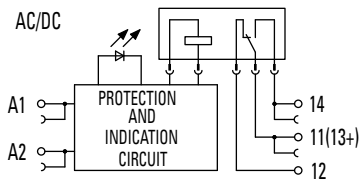

6mm Solid State Relay

INPUT : AC120V,AC240V
OUTPUT : DC24V

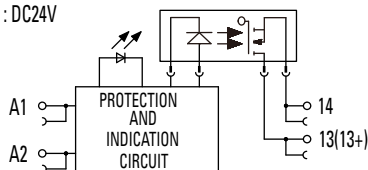

INPUT : DC6V,DC24V
OUTPUT : DC24V

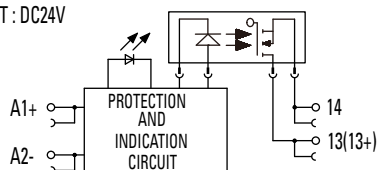

INPUT : AC120V,AC240V
OUTPUT : DC48V

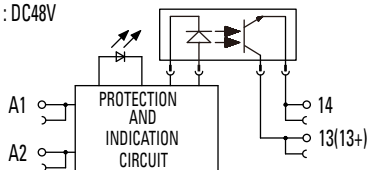

INPUT : DC6V,DC24V
OUTPUT : DC48V

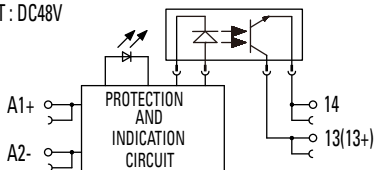

INPUT : AC120V,AC240V
OUTPUT : AC240V

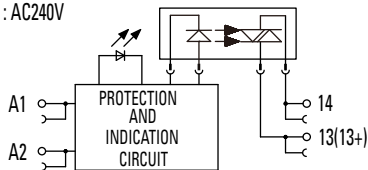

INPUT : DC6V,DC24V
OUTPUT : AC240V

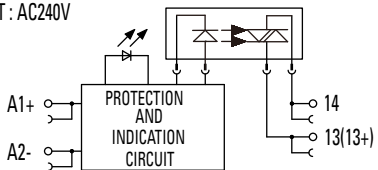

14mm Electromechanical Relay 1 Pole

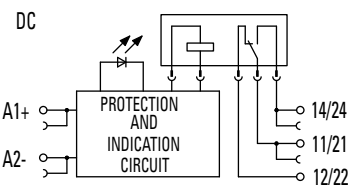
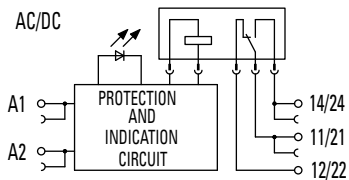

14mm Electromechanical Relay 2 Pole

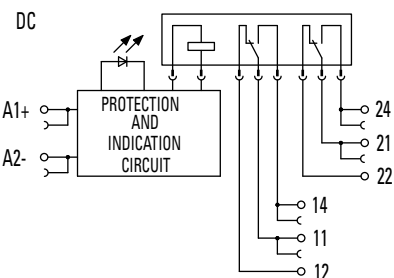
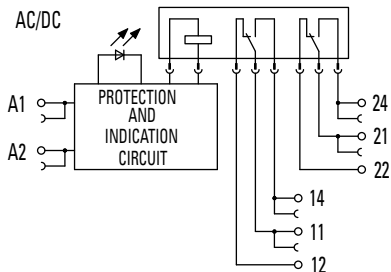

Accessories Dimensions

SV9Z-PW10* Marking Plate

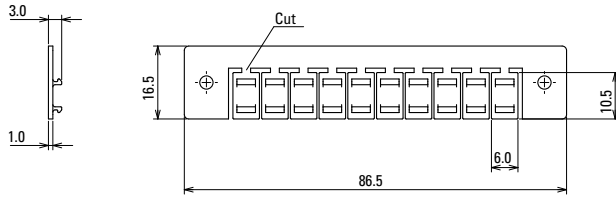

*Available blank or pre-marked.

SV9Z-J20* Jumper for 6mm Relay

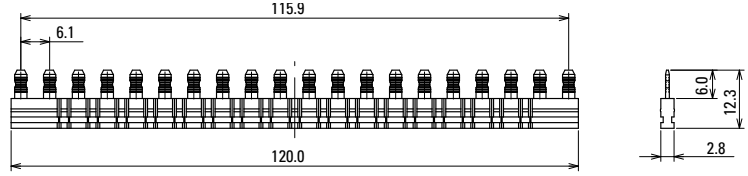

*Available in Black, Gray and Blue

SV9Z-SA2W Spacer for 6 and 14mm Relay

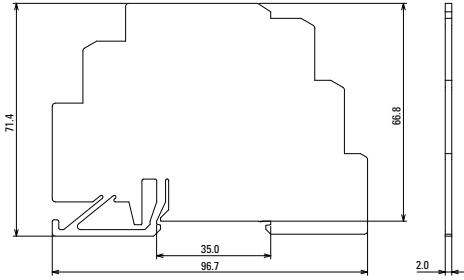

SV9Z-J232* Jumper for 14mm Relay

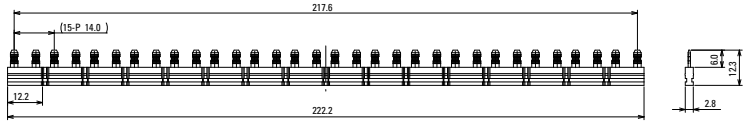

* Available in black, gray and blue.

Characteristics

6mm Electromechanical Relay

Maximum Switching Power AC

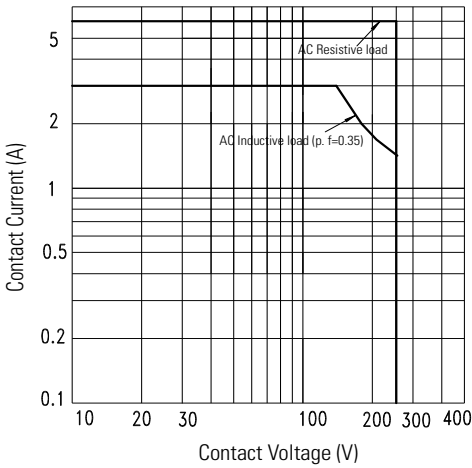

Maximum Switching Power DC

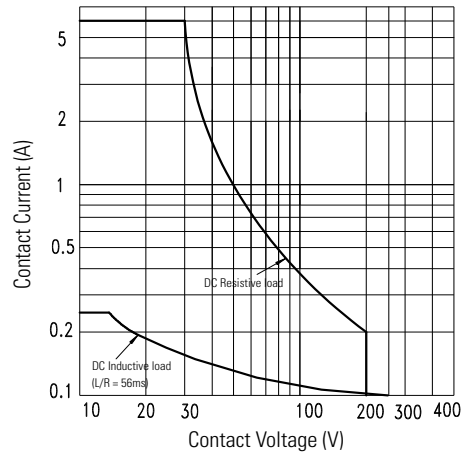

6mm Solid State Continuous Load Current vs. Ambient Temperature Curves

24V DC

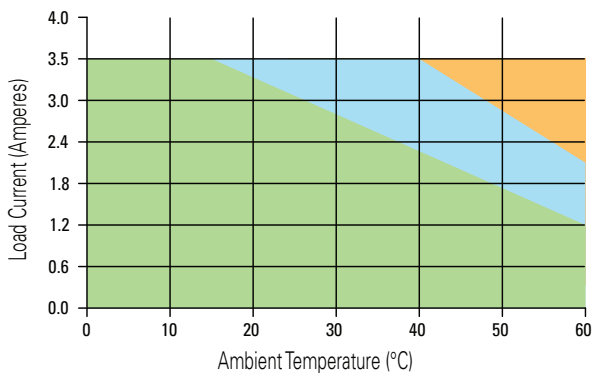

48V DC

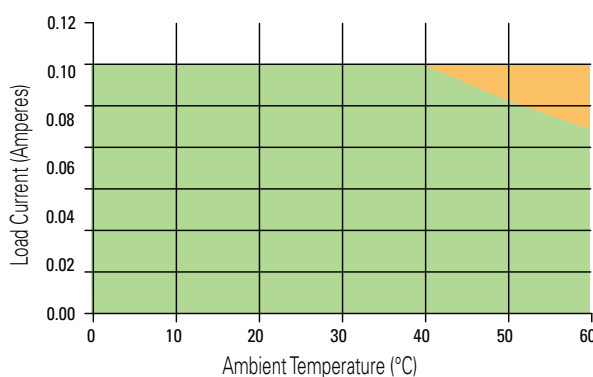

240V AC Zero Cross

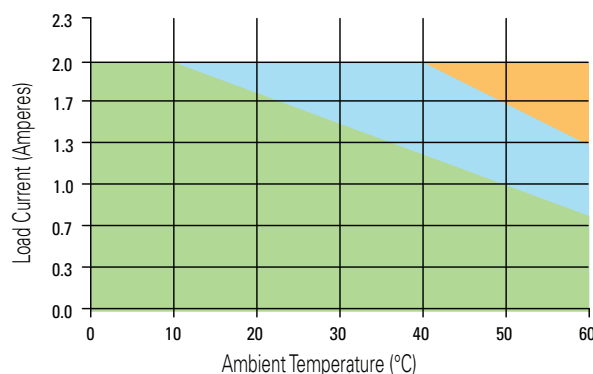

240V AC Random Cross

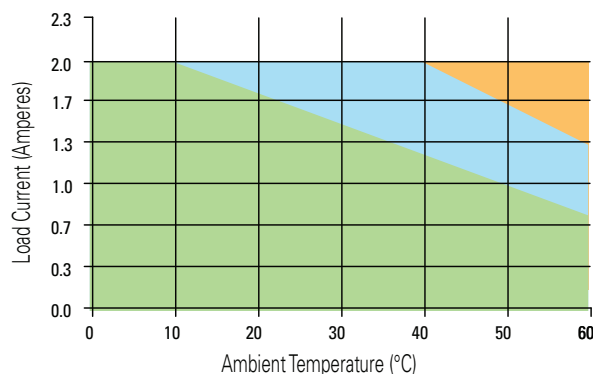

Legend

- No spacing required between units.
- Spacing of 6.2mm minimum required between units
- Not Recommended

Switches & Pilot Lights

Signaling Lights

Relays & Sockets

Timers

Contactors

Terminal Blocks

Circuit Breakers

14mm Electromechanical Relays

Switches & Pilot Lights
Signalizing Lights

14 mm Electrical Life Curve AC Load

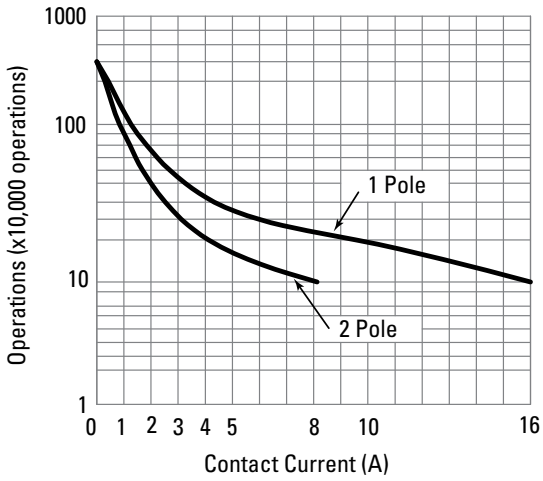

Relays & Sockets

14mm Contact Ratings

AC

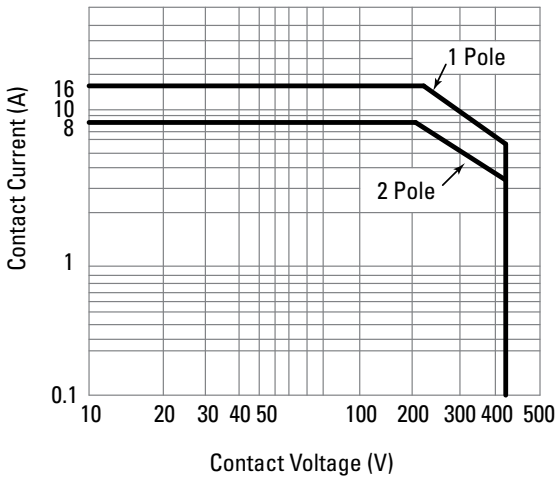

Timers

DC

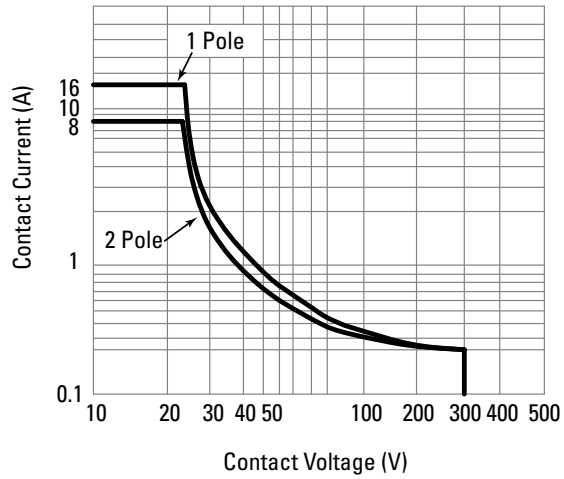

Contactors

Terminal Blocks

Circuit Breakers