

Think Automation and beyond...

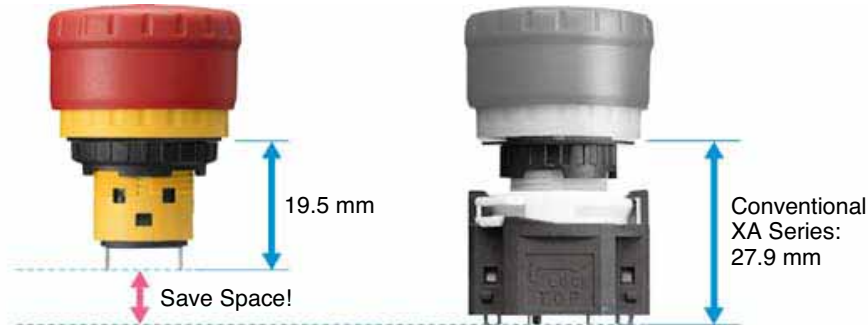

Ø16mm XA Series Emergency Stop Switches (Unibody Type)

Only 19.5mm behind the panel, compact Ø16mm emergency stop switches.



Ideal for installing in equipment which has mounting limitations

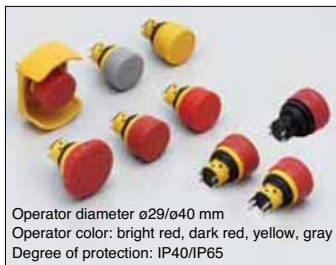

Easy to Reset



Push-to-lock, Pull/turn-to-reset

Resetting is possible by either pulling or turning the button, allowing for easy operation.

Unlatching by pulling



Unlatching by turning



IDEC's emergency stop switches value safety.

Safety Potential Structure

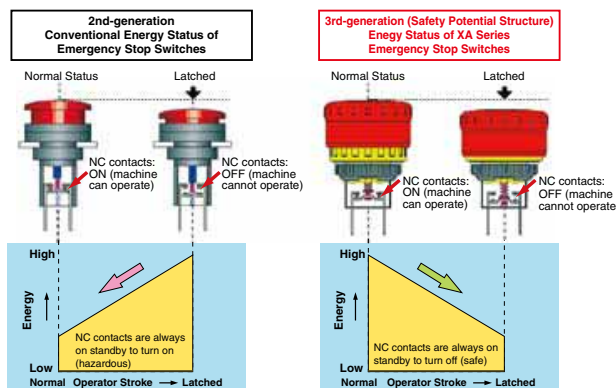

Direct Opening Action

Achievement of contact separation (of a contact element) of the switch actuator through a direct mechanical link (for example not dependent upon springs) (IEC 60947-5-5; 5.2, IEC 60947-5-1; Annex K)



Safe Lock Mechanism

The emergency stop signal shall be maintained until the emergency stop device is reset (disengaged). (IEC 60947-5-5; 6.2)

International Safety Standards



With XA emergency stop switches, the potential energy level of the latched status is lower than that of normal status. In the event the switch is damaged due to excessive shocks, the NC contacts will turn off, thus stopping the machine (patented).

IDEC CORPORATION

ø16 XA Series Emergency Stop Switches (Unibody Type)

Small, unibody emergency stop switches suitable for equipment with small mounting space. Requires only ø16mm × 19.5mm for installation.

- ø29mm and ø40mm mushroom operators
- Degree of protection IP65 and IP40 (IEC 60529)
- Emergency stop switch operators are available in red (Munsell 5R4/12)
- Stop switch operators come in yellow or gray
- Gold-plated crossbar contacts
- Push-to-lock, pull or turn-to-reset operator
- UL, c-UL recognized. EN compliant.
- Safety lock mechanism (IEC 60947-5-5, 6.2)
- Direct opening action mechanism (IEC 60947-5-5, 5.2, IEC60947-5-1, Annex K)

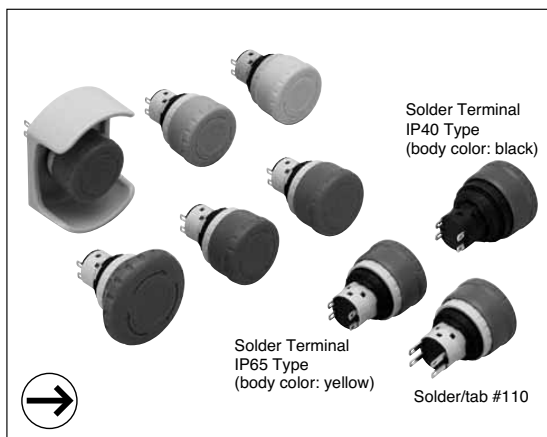

Standards

Standards	Mark	Organization/File No.
UL508 CSA C22.2 No.14		UL/c-UL File No. E68961
EN60947-5-5 (Note)		TÜV SÜD
		European Commission's Low Voltage Directive

Note: Except for stop switches (operator color: yellow and gray)

Contact Ratings

Rated Insulation Voltage (Ui)		250V			
Thermal Current (Ith)		5A			
Rated Operating Voltage (Ue)		30V	125V	250V	
Rated Operating Current	AC 50/60Hz	Resistive Load (AC-12)	—	5A	3A
		Inductive Load (AC-15)	—	3A	1.5A
	DC	Resistive Load (DC-12)	2A	0.4A	0.2A
		Inductive Load (DC-13)	1A	0.22A	0.1A

- Minimum applicable load: 5V AC/DC, 1 mA (reference value) (May vary depending on the operating conditions and load.)
- The rated operating currents are measured at resistive/inductive loads as specified in IEC 60947-5-1.

Specifications





Applicable Standards	UL508, CSA C22.2 No.14 IEC 60947-5-1, EN 60947-5-1 IEC 60947-5-5 (Note), EN 60947-5-5 (Note) JIS C8201-5-1
Operating Temperature	-25 to +60°C (no freezing)
Operating Humidity	45 to 85% RH (no condensation)
Storage Temperature	-45 to +80°C (no freezing)
Operating Force	Push-to-lock: 10.5N Pull to reset: 10N Turn to reset: 0.16 N·m
Minimum Force Required for Direct Opening Action	40N
Minimum Operator Stroke Required for Direct Opening Action	4.0 mm
Maximum Operator Stroke	4.5 mm
Contact Resistance	50 mΩ maximum (initial value)
Insulation Resistance	100 MΩ minimum (500V DC megger)
Overvoltage Category	II
Impulse Withstand Voltage	2.5 kV
Pollution Degree	3
Operating Frequency	900 operations/hour
Shock Resistance	Operating extremes: 150 m/s ² Damage limits: 1000 m/s ²
Vibration Resistance	Operating extremes: 10 to 500 Hz, amplitude 0.35mm, acceleration 50 m/s ² Damage limits: 10 to 500 Hz, amplitude 0.35 mm, acceleration 50 m/s ²
Durability	Mechanical: 250,000 Electrical: 100,000 250,000 (24V AC/DC, 100mA)
Degree of Protection	IP65, IP40 (IEC 60529)
Short-circuit Protection	250V/10A fuse (Type aM IEC 60269-1/IEC 60269-2)
Conditional Short-circuit Current	1000A
Terminal Style	Solder terminal, Solder/tab #110 terminal
Recommended Tightening Torque for Locking Ring	0.88 N·m
Applicable Wire Size	1.25 mm ² maximum (AWG16 maximum)
Terminal Soldering Condition	310 to 350°C, within 3 seconds
Weight (approx.)	ø29mm mushroom: 14g ø40mm mushroom: 17g

Note: Except for stop switches (operator color: yellow and gray)

XA Series Emergency Stop Switches (Unibody Type) ø16



Part Numbers

• Solder Terminal Type Emergency Stop Switches

Shape	Contact	Part No.	
		IP40 (contact part: black)	IP65 (contact part: yellow)
ø29mm Mushroom  	1NC	XA1E-BV3U01K-R	XA1E-BV3U01-R
	2NC	XA1E-BV3U02K-R	XA1E-BV3U02-R
ø40mm Mushroom  	1NC	XA1E-BV4U01K-R	XA1E-BV4U01-R
	2NC	XA1E-BV4U02K-R	XA1E-BV4U02-R

• Solder/tab #110 terminal is also available. Specify "T" before "-R" in the Part Number.
 For example, XA1E-BV3U02K-R becomes XA1E-BV3U02KT-R.

• Solder Terminal Type Stop Switches

Shape	Operator Type	Contact	Part No.		① Operator Color Code
			IP40 (contact part: black)	IP65 (contact part: yellow)	
 	ø29mm Mushroom	1NC	XA1E-BV3U01K-①	XA1E-BV3U01-①	Y: yellow N: gray
		2NC	XA1E-BV3U02K-①	XA1E-BV3U02-①	
	ø40mm Mushroom	1NC	XA1E-BV4U01K-①	XA1E-BV4U01-①	
		2NC	XA1E-BV4U02K-①	XA1E-BV4U02-①	

• Solder/tab #110 terminal is also available. Specify "T" before "-①" in the Part Number.
 For example, XA1E-BV3U02K-Y becomes XA1E-BV3U02KT-Y.

Dimensions

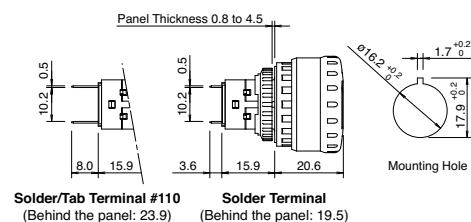

Terminal Arrangement (Bottom View)

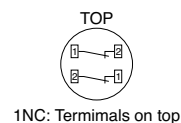

Mounting Hole Layout

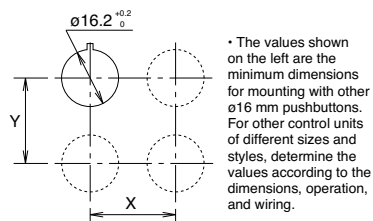

ø29 mm Mushroom

ø40 mm Mushroom

All dimensions in mm.

	X	Y
ø29mm Mushroom	40 mm minimum	
ø40mm Mushroom	50 mm minimum	

ø16 XA Series Emergency Stop Switches (Unibody Type)

Nameplate

Description	Legend	Part No.	Dimensions		Remarks
			For ø29mm Mushroom	For ø40mm Mushroom	
For ø29mm Mushroom	Blank	HAAV-0			Mounting panel thickness: 0.5 to 3 mm Material: Polyamide Nameplate color: yellow Legend color: black
	EMERGENCY STOP	HAAV-27			
For ø40mm Mushroom	Blank	HAAV4-0			
	EMERGENCY STOP	HAAV4-27			

• See "When using a nameplate" in Instructions below.

Accessories

Shape	Material	Part No.	Package Quantity	Remarks
	Metal (nickel-plated brass)	MT-001	1	Used to tighten the locking ring when installing the XA switch onto a panel. Tightening torque: 0.88 N·m maximum

• SEMI S2-compliant switch guard (XA9Z-KG1) and EMO label (HW9Z-EMO-NPP) are also available.

Safety Precautions

- Turn off power to the XA series emergency stop switch before installation, removal, wiring, maintenance, and inspection of the switches. Failure to turn power off may cause electrical shocks or fire hazard.
- For wiring, use wires of a proper size to meet voltage and current requirements and solder correctly. Failure to solder correctly may cause overheating and fire.

Instructions

Panel Mounting

Remove the locking ring from the operator and check that the gasket is in place. Insert the operator from panel front into the panel hole. Face the side with a projection upward, and tighten the locking ring.

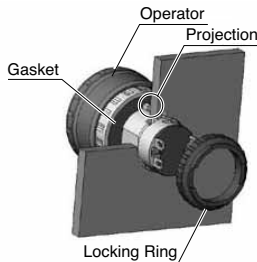

• Notes for Panel Mounting

Using ring wrench MT-001, tighten the locking ring to a torque of 0.88 N·m. Do not use pliers. Do not apply excessive force, otherwise the locking ring will be damaged.

Wiring

1. The applicable wire size is 1.25 mm² maximum.
2. Solder the terminals using a soldering iron at 310 to 350°C for 3 seconds. Make sure that the soldering iron touches the terminals only, not plastic parts. When wiring, do not apply external force such as bending the terminals or applying tensile force on the wires.
3. Use a non-corrosive rosin flux.
4. Because the terminal spacing is narrow, use protective tubes or heat shrinkable tubes to avoid burning wire insulation or short circuit.
5. Solder/Tab Terminal #110
 - Use #110 receptacles for 0.5mm-thick tabs.
 - Because the terminal spacing is narrow, use protective tubes or heat shrinkable tubes of 0.5mm minimum in thickness.
6. Do not apply force on the terminals in the direction other than vertical to the mounting panel, otherwise the terminals will be damaged.

Contact Bounce

When the button is reset by pulling or turning, the NC contacts will bounce. When designing a control circuit, take the contact bounce time into consideration (reference value: 20 ms).

Nameplate

Remove the projection from the nameplate using pliers, otherwise the switch cannot be installed.

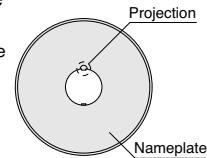

Handling

Do not expose the switch to excessive shock and vibrations, otherwise the switch may be deformed or damaged, causing malfunction or operation failure.



Specifications and other descriptions in this catalog are subject to change without notice.



IDEC CORPORATION

7-31, Nishi-Miyahara 1-Chome, Yodogawa-ku, Osaka 532-8550, Japan
Tel: +81-6-6398-2571, Fax: +81-6-6392-9731
E-mail: products@idec.co.jp

IDEC CORPORATION (USA)
1175 Elko Drive, Sunnyvale, CA 94089-2209, USA
Tel: +1-408-747-0550 / (800) 262-IDECE (4332)
Fax: +1-408-744-9055 / (800) 635-6246
E-mail: opencontact@idec.com

IDEC CANADA LIMITED
3155 Pepper Mill Court, Unit 4, Mississauga, Ontario, L5L 4X7, Canada
Tel: +1-905-890-8561, Toll Free: (888) 317-4332
Fax: +1-905-890-8562
E-mail: sales@ca.idec.com

IDEC AUSTRALIA PTY. LTD.
2/3 Macro Court, Rowville, Victoria 3178, Australia
Tel: +61-3-9763-3244, Toll Free: 1800-68-4332
Fax: +61-3-9763-3255
E-mail: sales@au.idec.com

IDEC ELECTRONICS LIMITED
Unit 2, Beechwood, Chineham Business Park, Basingstoke, Hampshire RG24 8WA, UK
Tel: +44-1256-321000, Fax: +44-1256-327755
E-mail: sales@uk.idec.com

IDEC ELEKTROTECHNIK GmbH
Wendenstrasse 331, 20537 Hamburg, Germany
Tel: +49-40-25 30 54 - 0, Fax: +49-40-25 30 54 - 24
E-mail: service@idec.de

IDEC (SHANGHAI) CORPORATION
Room 608-609, 6F, Gangtai Plaza, No. 700, Yan'an East Road, Shanghai 200001, PRC
Tel: +86-21-5353-1000, Fax: +86-21-5353-1263
E-mail: idec@cn.idec.com

IDEC (BEIJING) CORPORATION
Room 211B, Tower B, The Grand Pacific Building, 8A Guanghua Road, Chaoyang District, Beijing 100026, PRC
Tel: +86-10-6581-6131, Fax: +86-10-6581-5119

IDEC (SHENZHEN) CORPORATION
Unit AB-3B2, Tian Xiang Building, Tian'an Cyber Park, Fu Tian District, Shenzhen, Guang Dong 518040, PRC
Tel: +86-755-8356-2977, Fax: +86-755-8356-2944

IDEC IZUMI (H.K.) CO., LTD.
Units 11-15, Level 27, Tower 1, Millennium City 1, 388 Kwun Tong Road, Kwun Tong, Kowloon, Hong Kong
Tel: +852-2803-8989, Fax: +852-2565-0171
E-mail: info@hk.idec.com

IDEC TAIWAN CORPORATION
8F-1, No. 79, Hsin Tai Wu Road, Sec. 1, Hsi-Chih, Taipei County, Taiwan
Tel: +886-2-2698-3929, Fax: +886-2-2698-3931
E-mail: service@tw.idec.com

IDEC IZUMI ASIA PTE. LTD.
No. 31, Tannery Lane #05-01, HB Centre 2, Singapore 347788
Tel: +65-6746-1155, Fax: +65-6844-5995
E-mail: info@sg.idec.com

www.idec.com