

# INSTRUCTION SHEET

Original Instructions  
Grip Style Three-Position Enabling Switch  
**HE2G Series**  
(Inside Connector Type)

Thank you for purchasing this IDEC product. Confirm that the delivered product is what you have ordered. Read this instruction sheet to make sure of correct operation.

## SAFETY PRECAUTIONS

In this operation instruction sheet, safety precautions are categorized in order of importance to Warning and Caution :

### WARNING

Warning notices are used to emphasize that improper operation may cause severe personal injury or death.

### CAUTION

Caution notices are used where inattention might cause personal injury or damage to equipment.

## 1 Type

**HE2G-21SCE-1N-L-K**

	Part A	Part B	Part C
None	None	None	None
L-L	Momentary pushbutton switch : 2C	Momentary pushbutton switch : 2C	None
L-K	Momentary pushbutton switch : 2C	Key selector switch : 2C	None
K-L	Key selector switch : 2C	Momentary pushbutton switch:2C	None
P*-0	None	None	Pilot light

Additional Control Unit

Rubber boot Material / Color  
blank : Silicon rubber / Yellow  
-1N : NBR/PVC Polyblend / Gray

Additional Emergency stop switch  
None : None  
E : Emergency stop switch: 2NC

Wiring way  
C : Connector

	3-Position Switch	Release monitor switch	Push monitor switch
20	2 contacts	None	None
21	2 contacts	1NC contact	None
21S	2 contacts	None	1NC contact

Contact IDEC, if require type not supplied as standard.

## 2 Specifications and Ratings

Applicable Standards	IEC 60947-5-1, EN 60947-5-1, JIS C 8201-5-1, GS-ET-22, UL508, CSA C22.2 No.14, GB/T14048.5, IEC 60947-5-8, EN 60947-5-8						
Standards for Use	ISO 12100 / EN ISO 12100, IEC 60204-1 / EN 60204-1, ISO 11161 / EN ISO 11161, ISO 10218-1 / EN ISO 10218-1, ANSI / RIA / ISO 10218-1, ANSI / RIA R15.06, ANSI B11.19, ISO 13849-1 / EN ISO 13849-1						
Applicable Directives	Low Voltage Directive, Machinery Directive, RoHS Directive						
Operating Condition	Operating Temperature	-25 to +60°C(no freezing) for silicon rubber boot -10 to +60°C(no freezing) for NBR/PVC polyblend rubber boot					
	Operating Humidity	45 to 85%RH (no condensation)					
	Storage Temperature	-40 to +80°C (no freezing)					
	Pollution Degree	3 (inside housing 2)					
	Altitude	2000m maximum					
Impulse Withstand Voltage (Uimp)	2.5 kV (Additional momentary pushbutton switch and Key selector switch : 1.5kV)						
Rated Insulation Voltage (Ui)	250V (Additional momentary pushbutton switch and Key selector switch:125V) / 30V (With Pilot Light)						
Thermal Current (Ith)	3A (Emergency stop switch: 5A)*1						
Contact Ratings (Reference Values) (Ue, Ie)*2	Switch	Three-position enabling switch (Inside Connector Pin No. A1-B1 and A3-B3)	AC	Resistive load (AC-12)	-	1A	0.5A
			DC	Resistive load (DC-12)	1A	0.2A	-
		AC	Inductive load (AC-15)	-	0.7A	0.5A	
			Inductive load (DC-13)	0.7A	0.1A	-	
		DC	Resistive load (AC-12)	-	0.5A	-	
			Inductive load (AC-15)	-	0.3A	-	

Push monitor switch, Release monitor switch (Inside Connector Pin No. A2-B2)	AC	Resistive load (AC-12)	-	2.5A	1.5A	
		Inductive load (AC-15)	-	1.5A	0.75A	
	DC	Resistive load (DC-12)	2.5A	1.1A	0.55A	
		Inductive load (DC-13)	2.3A	0.55A	0.27A	
	Emergency stop switch (Inside Connector Pin No. A1-B1 and A2-B2)	AC	Resistive load (AC-12)	-	5A	3A
			Inductive load (AC-15)	-	3A	1.5A
DC		Resistive load (DC-12)	2A	0.4A	0.2A	
		Inductive load (DC-13)	1A	0.22A	0.1A	
Momentary pushbutton switch, Key selector switch (Inside Connector Pin No.A1-A2, A3, No.B1-B2, B3)	AC	Resistive load (AC-12)	-	0.5A	-	
		Inductive load (AC-15)	-	0.3A	-	
	DC	Resistive load (DC-12)	1A	0.2A	-	
		Inductive load (DC-13)	0.7A	0.1A	-	
Electric Shock Protection Class	Class II (IEC 61140) □, Class III (With Pilot Light)					
Operation Frequency	1200 operations / hour					
B10d	100,000 (EN ISO 13849-1 Annex C Table C.1)					
Mechanical Durability	Position 1⇒2⇒1 : 1,000,000 operations min. Position 1⇒2⇒3⇒1 : 100,000 operations min.					
Electrical Durability	100,000 operations min. (Rated operating load) 1,000,000 operations min. (AC/DC 24V 100mA)					
Shock Resistance	Operating Extremes 150m/s <sup>2</sup>					
	Damage Limits 1000m/s <sup>2</sup>					
Free Fall	1.0m 1time (Based on IEC 60068-2-32)					
Vibration Resistance	Operating Extremes 5 to 55 Hz, half amplitude 0.5 mm					
	Damage Limits 16.7 Hz, half amplitude 1.5 mm					
Degree of Protection	IP66 / 67 Without Additional switch and Pilot light					
	IP65 With Additional switch and/or Pilot light					
Conditional short-circuit Current	50A (250V)					
Short-Circuit Protective Device	250V AC,10A Fuse (IEC 60127-1)					
Direct Opening Force	60 N minimum (Release monitor switch and Push monitor Switch)					
Direct Opening Travel	1.7 mm minimum (Release monitor switch), 4.7 mm minimum (Push monitor Switch)					
Actuator Strength	500 N minimum (when pressing the entire button surface) (Three-Position Enabling Switch)					
Weight(Approx.)	HE2G-2□C (145g) / -L-L (165g) / -L-K (170g) / -P*-0 (150g) HE2G-2□CE (155g) / -L-L (175g) / -L-K (180g) / -P*-0 (160g)					
Pilot Light	Rated Operating Voltage	24V DC ±10%				
	Rated Current	15mA				
	Light Source	LED				
Illumination Color	* : None (Green), R (Red), Y (Yellow), A (Amber), W (White)					
Switch / Pilot light side Connector	Made by Tyco Electronics AMP K.K.					
		Three-Position Enabling Switch / Momentary pushbutton switch / Key selector switch	Emergency stop switch	Pilot light		
	Series	D-1200D		D-1200S		
	Tab Housing	1-1903130-3	1-1903130-2	1-1903129-2		
Tab Contact	1903116-2					
Cable side Applicable Connector *Please prepare by the user	Made by Tyco Electronics AMP K.K.					
		Three-Position Enabling Switch / Momentary pushbutton switch / Key selector switch	Emergency stop switch	Pilot light		
	Series	D-1200D		D-1200S		
	Receptacle Housing	1-1827864-3	1-1827864-2	1-1871465-2		
Receptacle Contact	1827586-2 / 1827587-2 / 1827588-2 / 1827589-2 ※3					

\*1 -25°C ≤ Operating temperature < 40°C 2.5A (12 to 19 pole) / 2A (20 to 22 pole)  
40°C ≤ Operating temperature < 50°C 2.5A (8 to 12 pole) / 2A (13 to 20 pole)  
50°C ≤ Operating temperature ≤ 60°C 2.5A (6, 7 pole) / 2A (8 to 13 pole) / 1.5A (14 to 22 pole)

\*2 As for the type with Pilot Light, Ue (Contact Ratings) of all switches is only less than 30V DC, and connect all switches to SELV (safety extra low voltage) or PELV (protective extra low voltage) circuit.

\*3 Confirm application of Receptacle Contact to use.

### Ratings approved by safety agencies

(1) TÜV Rating

Without Pilot Light Type

Three-position enabling switch	AC-15 250V/0.5A	DC-13 125V/0.1A
Monitor switch	AC-15 250V/0.75A	DC-13 30V/0.7A
		DC-13 125V/0.22A
		DC-13 30V/2.3A

With Pilot Light Type

Three-position enabling switch		DC-13 30V/0.7A
Monitor switch		DC-13 30V/2.3A

(2) UL, c-UL Rating

Three-position enabling switch	AC 250V/0.5A	Pilot Duty
	DC 125V/0.1A	Pilot Duty
	DC 30V/0.7A	Pilot Duty
Monitor switch	AC 250V/0.75A	Pilot Duty
Emergency stop switch	AC 250V/1.5A	Pilot Duty
	DC 30V/1A	Pilot Duty
Momentary pushbutton switch / Key selector switch	AC 125V/0.5A	Resistive
	DC 30V/1A	Resistive

- Pilot Light DC 24V/15mA
- Ambient Temperature 40°C
  - Environmental Rating Type 4X Indoor Use Only
- (This device must be used with cable suitable for wet locations, when using as UL/c-UL recognized component. Extra care shall be taken to make sure that the mating components of the housing are suitably aligned in order to maintain the Type 4X Indoor Use Only rating.)
- This device has only been investigated for shock and fire to UL508.
  - This device is not intended for connection to rigid metallic conduit.

(3) CCC Rating

Three-position enabling switch	AC-15 250V/0.5A	DC-13 30V/0.7A
Monitor switch	AC-15 250V/0.75A	DC-13 30V/2.3A
Emergency stop switch	AC-15 250V/1.5A	DC-13 30V/1A
Momentary pushbutton switch / Key selector switch	AC-12 125V/0.5A	DC-12 30V/1A
Pilot Light	DC 24V/15mA	

### 3 Unpacking

Check if the product is what you have ordered and there are no lacks of parts or damages by a transport accident, before use.

- A grip style three-position enabling switch (consisting of a base and a rubber boot frame)
  - A connector (applicable cable diameter : Φ4.5 to 10 mm)
  - An instruction sheet
  - Key (with key selector switch)
- Note : Use the connector with the specification below when replacing. (a connector included with grip style three-position enabling switch.)

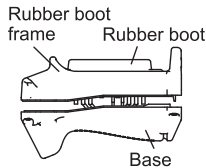

- Dimensions

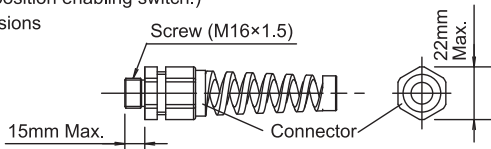

- Degree of Protection : Use a connector of IP67 or higher protection.
- Recommended connector : Type No.: SKINTOP-BS-M16x1.5-LG (made by LAPP, Germany)
- Applicable cable diameters : Outside diameter 4.5 to 10 mm

### 4 Instruction

- This grip style three-position enabling switch is a device used for enabling a machine (robot, etc.) when teaching the machine in a hazardous area manually. Configure the enabling system so that the machine can operate when the switch is in position 2 and an additional "start" is pushed to initiate the operation.
- In order to ensure safety of the control system, connect each pair of the contacts of the three-position enabling switch (Inside Connector Pin No. A1-B1 and A3-B3) to a discrepancy detection circuit such as a safety relay module. (EN ISO 13849-1)
- The base and the plastic part of rubber boot frame are made of glass-reinforced ABS/PBT. The rubber boot is made of silicone rubber or NBR/PVC polyblend. The screw is made of iron. When cleaning the grip style three-position enabling switch, use a detergent compatible with the materials.
- As for momentary pushbutton switch and key selector switch of additional control unit, do not connect NO and NC contacts of a microswitch to different voltages or different power sources to prevent a dead short-circuit.
- Do not operate key selector switch of additional control unit, without completely insertion of the key.
- The rubber boot may deteriorate depending on the operating environment and conditions. Immediately replace the deformed or cracked rubber boot with new ones.

#### Replacement rubber boot (separate order)

Type	Rubber boot Material	Rubber boot Color
HE9Z-D2Y	Silicon rubber	Yellow
HE9Z-D2B	Silicon rubber	Black
HE9Z-D2N1	NBR/PVC polyblend	Gray

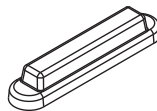

Note : When replacing rubber boot, read the instruction sheet and catalog of HE2B double three-position enabling switch.

### WARNING

- Turn off the power to the grip style three-position enabling switch before starting installation, removal, wiring, maintenance, and inspection. Failure to turn power off may cause electrical shocks or fire hazard.
- Do not disassemble or modify the switch. Also do not attempt to disable the grip style three-position enabling switch function, otherwise a breakdown or an accident will result.
- When using the HE2G Grip Style Three-Position Enabling Switch for safety-related equipment in a control system, refer to the safety standards and regulations in each country and region depending on the application purpose of the actual machines and installations to make sure of correct operation. Also, perform risk assessment to make sure of safety before starting operation.
- Do not tie the grip style three-position enabling switch around the button with a

- tape or string to keep the switch in position 2. Otherwise the original function of the switch is not utilized, posing a great risk of danger.
- Please note that permanent installation of the Grip Style Three-Position Enabling Switch at the machine is inadmissible.

### CAUTION

- Use proper size wires to meet voltage and current requirements.
- Do not apply an excessive shock to the grip style three-position enabling switch.
- Wire the switch correctly after reading a catalog or this instruction sheet.
- When wiring, prevent dust, water, or oil from entering the grip style three-position enabling switch.
- If used in wet locations, this device must be used with cable suitable for wet locations.
- To prepare correct Cable Side Applicable Connector for the connector type, read the instruction sheet and catalog of Tyco Electronics AMP K.K. and understand the installation and wiring method.
- If multiple safety components are wired in series, the Performance Level to EN ISO 13849-1 will be reduced due to the restricted error detection under certain circumstance.
- The entire concept of the control system, in which the safety component is integrated, must be validated to EN ISO 13849-2.

### 5 Wiring

#### Operating Characteristics (Pressing the center of the button)

■ : ON (Contact close) □ : OFF (Contact open)

- Three-Position Enabling Switch

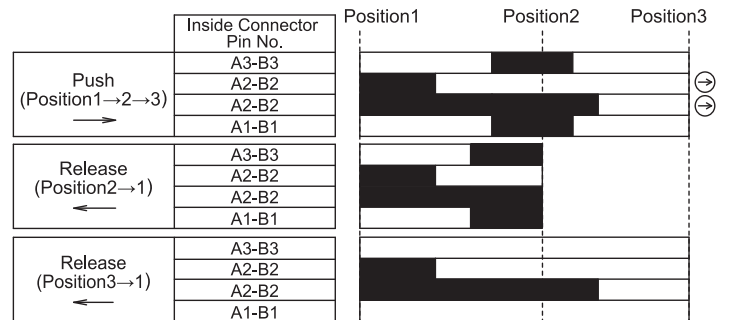

- Three-Position Enabling Switch : 2 contacts  
Inside Connector Pin No. : between A1 and B1, between A3 and B3
- Release monitor Switch : 0 to 1 contact  
Inside Connector Pin No. : between A2 and B2 (HE2G-21C)
- Push monitor Switch : 0 to 1 contact  
Inside Connector Pin No. : between A2 and B2 (HE2G-21SC)

Inside Connector Pin No.

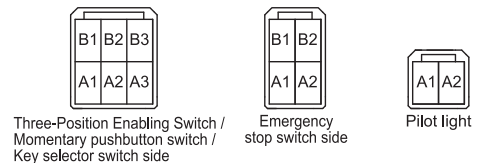

### CAUTION

- Release monitor switch (Inside Connector Pin No. A2-B2 of HE2G-21C) will be positive opening circuit (⊕) when the switch operates from position 1 to 2. Push monitor switch (Inside Connector Pin No. A2-B2 of HE2G-21SC) will be positive opening circuit (⊕) when the switch operates from position 2 to 3.
- Use contacts of Inside Connector Pin No. A1-B1 and A3-B3 for the output of enabling system.
- The above operating characteristics illustrate the performance when the center of the rubber boot is pressed. Pressing the edge activates one of the two three-position enabling switches inside earlier than the other, and may cause a delay in the operation of the grip style three-position enabling switch.

- Key selector switch

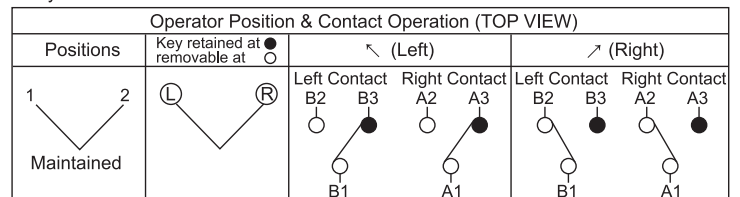

- Pilot light A1(+) ○ — ○ — A2(-)

Pay attention to the polarity of the power supply as UP series units do not contain a diode for protection against reverse polarity. Inside Connector Pin No. A1 is positive, B1 is negative.

Wire Length inside the grip style three-position enabling switch

	Grip Style Three-Position Enabling Switch	Momentary pushbutton switch / Key selector switch	Emergency stop switch	Pilot Light
Sheath stripping Length L1 (mm)	20	60	75	70

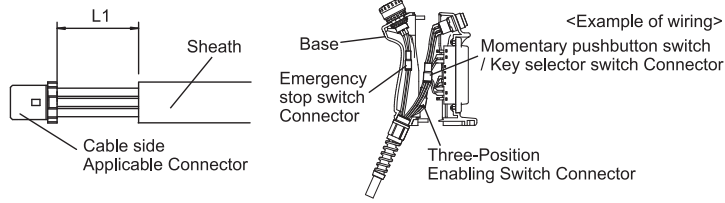

Applicable Wire Size in Cable Side Applicable Connector

• Direct wiring : 0.05 to 0.86 mm<sup>2</sup>(AWG30-18) x 1pc  
 Confirm application of Receptacle Contact to use.  
 Applicable tool : 1762846-1 (Manual Tool)  
 Wire HE2G Grip Style Three-Position Enabling Switch according to IEC 60204-1  
 Note : When using a stranded wire, make sure that adjoining terminals are not short-circuited with protruding core wires. Also, do not solder the core wires to avoid protruding wires. Use copper Wire 60/75 degree C only. (UL508) The wiring has to be installed according to GS-ET-22, 4.2.6.

Wiring Process of Connector

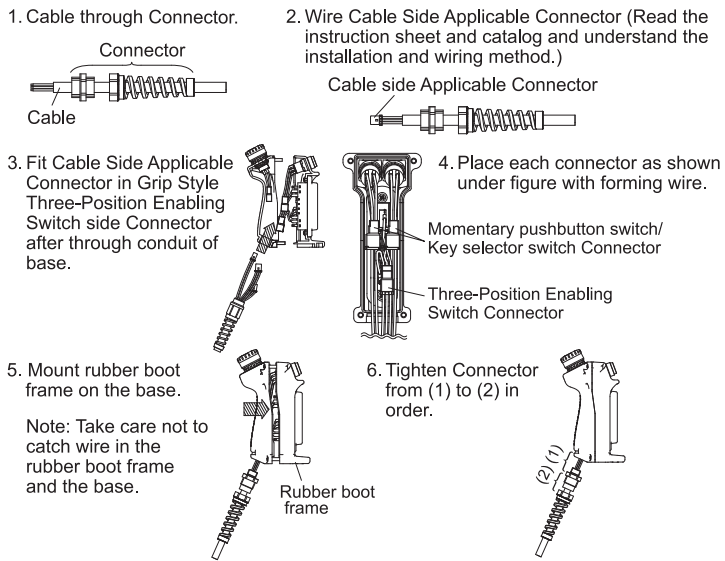

Recommended screw tightening torque

	Screw position	Screw tightening torque
For mounting rubber boot frame on the base (M4 screw x4)	A	1.1 to 1.3N·m
Connector to Grip Style Three-Position Enabling Switch	B	2.7 to 3.3N·m
Connector to Connector	C	2.7 to 3.3N·m
For mounting HE2B double three-position enabling switch (M3 screw x2)*	D	0.5 to 0.8N·m

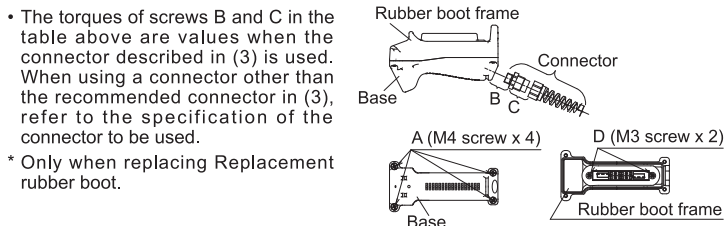

Example of wiring Diagram realizing Safety Category4

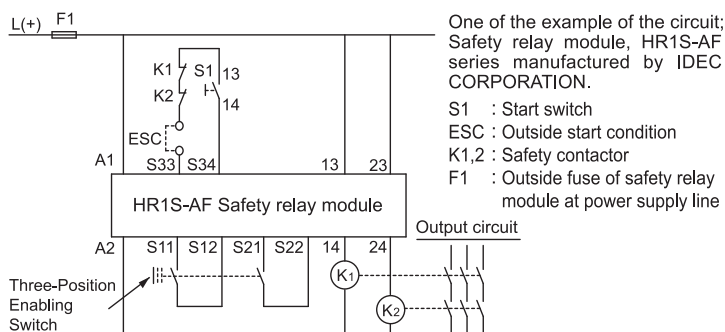

N(-) Note : Use the monitoring device(Safety relay module) provided the capability

to detect a cross short circuit. The insulation of the cable has to withstand environmental influences. If a control device other than the one shown in the draft is used, the used control device has to be equipped with a cross short circuit monitor.

6 Dimensions (mm)

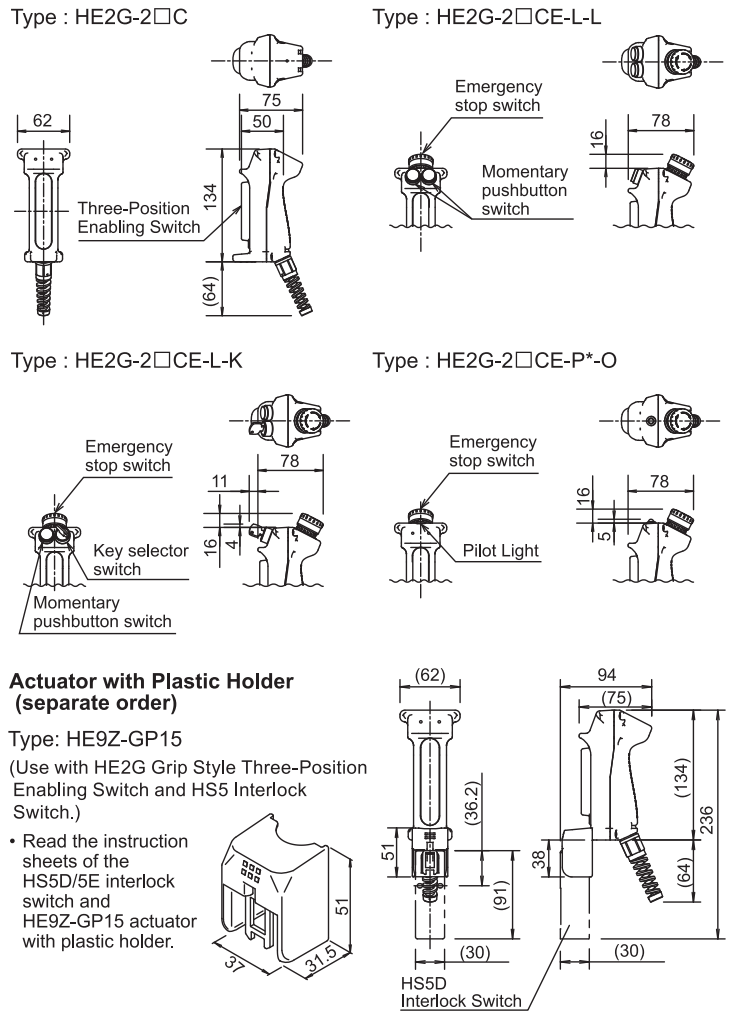

Actuator with Plastic Holder (separate order)

Type: HE9Z-GP15  
 (Use with HE2G Grip Style Three-Position Enabling Switch and HS5 Interlock Switch.)  
 • Read the instruction sheets of the HS5D/5E interlock switch and HE9Z-GP15 actuator with plastic holder.

Hand Strap (separate order)

Type: HG9Z-PS1  
 (Install HE2G • Prevent drop)  
 \* Use HE9Z-PS1 through a wrist by all means.

\* Do not use Mounting bracket (Type : HE9Z-GH1) for installing HE2G Grip Style Three-position Enabling Switch. When installing HE2G Grip Style Three-position Enabling Switch on the walls, attach Hand Strap (Type : HG9Z-PS1) to HE2G Grip Style Three-position Enabling Switch and hang on a hook.

7 Precaution for Disposal

Dispose of HE2G Grip Style Three-Position Enabling Switch as an industrial waste.

IDEC CORPORATION <http://www.idec.com>

**Manufacturer: IDEC CORP.**  
 2-6-64 Nishimiyahara Yodogawa-ku, Osaka 532-0004, Japan  
**EU Authorized Representative: APEM SAS**  
 55, Avenue Edouard Herriot BP1, 82303 Caussade Cedex, France  
**EU DECLARATION OF CONFORMITY**  
 We, IDEC CORPORATION 2-6-64, Nishimiyahara Yodogawa-ku, Osaka 532-0004, Japan declare under our sole responsibility that the product:  
 Description: Grip Style Three-Position Enabling Switch  
 Model No: HE2G  
 Applied Union harmonized legislation and references to the relevant harmonization standards used or references the other technical specifications in relation to which conformity is declared.  
 Applicable EU Directive : Low Voltage Directive (2014/35/EU), Machinery Directive (2006/42/EC), RoHS Directive (2011/65/EU)  
 Applicable Standard(s) : EN 60947-5-1, GS-ET-22, EN IEC 63000  
**UK Authorized Representative: APEM COMPONENTS LIMITED**  
 Drakes Drive, Long Crendon, Buckinghamshire, HP18 9BA, UK  
 Applicable UK Directive : Electrical Equipment (Safety) Regulations 2016, Supply of Machinery (Safety) Regulations 2008, The Restriction of the Use of Certain Hazardous Substances in Electrical and Electronic Equipment Regulations 2012  
 Applicable Standard(s) : EN 60947-5-1, EN IEC 63000