



WB2F 2D Code Scanner

PLC Connection User's Manual



Introduction

Attention

- IDEC Corporation holds all rights related to this manual. Unauthorized duplication, reproduction, sales, transfers, or leasing without the express consent of IDEC is prohibited.
- Information contained in this manual may be changed or updated without notice.
- Every effort has been made to ensure the accuracy of the information contained in this manual. However, if you do note any errors or inconsistencies please contact the dealer from which you purchased the product or an IDEC sales representative.





Trademarks

MELSEC and GX Works2 are registered trademarks of Mitsubishi Electric Corporation.

Graphic Symbol Glossary

This manual uses the following graphic symbols to simplify explanations:

Notes

Graphic Symbol	Description
 Warning	Failure to operate the product in accordance with the information provided may result in severe personal injury or death.
 Caution	Failure to operate the product in accordance with the information provided may result in personal injury or damage to equipment.
	Notes information that should be carefully noted. Failure to operate the product in accordance with the information provided may affect the appearance and performance of the main unit as well as any peripheral devices.
	Denotes additional information that may prove useful for using a given function.

Related manuals

Manuals related to the WB2F are as follows. Refer to them together with this manual.

All related manuals are available for download from our website.

Type	Manual name	Details
B-1960	WB2F 2D Code Scanner PLC Connection User's Manual (this manual)	Explains about PLC Connection.
B-1945	Instruction Sheet: WB2F 2D Code Scanner	Included with the product.
B-1946	Instruction Sheet: WB9Z-CU100 Communication Unit	Included with the product.
B-1952	WB2F 2D Code Scanner User's Manual	Gives an overview of the functions and capabilities of the WB2F, and instructions on its use.
B-1964	Communication Unit Supporting Code Scanner WB9Z-CU100 User's Manual	Gives an overview of the functions and capabilities of the communication unit as well as instructions on its use.

Contents

Introduction i

Attention.....	i
Trademarks.....	i
Graphic Symbol Glossary	i
Notes.....	i
Related manuals.....	ii

Contents iii

1 Overview 1-1

1.1 PLC connection.....	1-1
1.2 Limitation.....	1-2
1.3 Applicable Models.....	1-2
1.4 Applicable PLC	1-2
1.5 Setting Parameters (WB2F).....	1-3

2 Operation Specifications 2-1

2.1 Overview	2-1
2.2 Assigning Data Memory	2-1
2.3 Special Area.....	2-2
2.4 Scanner Information Area.....	2-4
2.5 Start and End	2-6
2.6 Operation Sequence	2-7

3 Setting and Wiring **3-1**

3.1	Connection to PLC	3-1
3.2	MC Protocol Setting	3-2
3.2.1	Overview	3-2
3.2.2	WB2F Setting examples	3-2
3.2.3	Communication unit setting example (WB9Z-CU100)	3-4
3.2.4	PLC Setting example	3-5
3.2.5	Wiring example	3-6

Index **A-1**

Revision history **A-2**

1 Overview

This chapter describes gives an overview, limitations, applicable models, applicable PLCs, and setting parameters of the PLC connection.

1.1 PLC connection

The PLC connection is a device in which the read result of symbols is directly written to the data memory of a PLC (Programmable Logic Controller).

The WB2F supports the PLC communication protocol, and there is no need to create a specific communication program in the PLC.

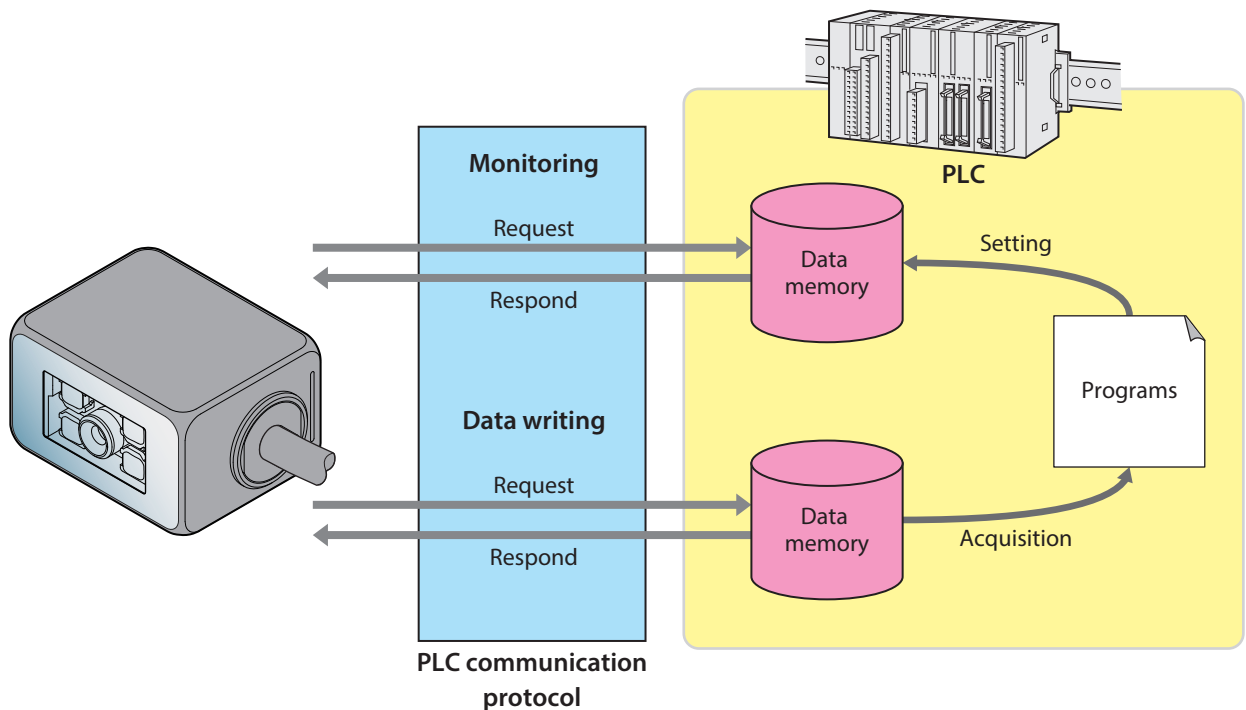

What is data memory?

It is the general storage area incorporated in PLC, allowing read and write. The data exchange between the WB2F and PLC uses data memory. The name and size corresponding to the data memory depends on the PLC. For details, refer to [\[3 Setting and Wiring\]](#) on page 3-1.

1.2 Limitation

Follow the limitations below when using the PLC connection.

- The maximum volume of symbol data transmittable to the PLC is 256 bytes.
- The function does not support the reading of symbol data containing a NULL(0x00)".
- Reading operation is available only at single read.
- The read request by the READ/ENTER button, external input, control command is invalid.
- The installation assistant function is not available.
- Reading and editing of the setting values is not available.

1.3 Applicable Models

The WB2F that supports the function is as follows:

Model	Version of main application	Remarks
WB2F-100S1B	A-001.000.00 and higher	Initial release version

1.4 Applicable PLC

The function is supported by the following PLCs:

Manufacturer	Series	Model	Connection method	Protocol			
Mitsubishi Electric	MELSEC iQ-R	RJ71C24* ¹	RS-232/RS-242	MC protocol (Model 4, 4C frame, with Checksum)			
		RJ71C24N-R2	RS-232				
		RJ71C24N-R4	RS-422				
	MELSEC iQ-F	FX5-232-BD* ¹	RS-232		MC protocol (Model 4, 4C frame, with Checksum)		
		FX5-232ADP* ¹					
		FX5U CPU unit (FX5U-32MT/ES)* ¹	RS-422				
		FX5UC CPU unit					
	MELSEC Q	QJ71C24N* ¹	RS-232/RS-422			MC protocol (Model 4, 4C frame, with Checksum)	
		QJ71C24N-R2	RS-232				
		QJ71C24N-R4	RS-422				
	MELSEC L	LJ71C24	RS-232/RS-422				MC protocol (Model 4, 4C frame, with Checksum)
		LJ71C24-R2* ¹	RS-232				

*1 In IDEC, the operation check is performed by these models.
For the other models, please perform the operation check at the customer's side before use.

1.5 Setting Parameters (WB2F)

The setting parameters and setting values necessary for the PLC connection are as follows:

Adjust the setting according to the using environment.



- All the settings of the WB2F should be performed before using the PLC connection.
- When the device of setting the WB2F (as PC) is different from the device to be connected through the PLC connection, prepare a cable supporting both devices.
- Do not access or change any settings that are not listed here.
- Do not access or change any settings in reserved areas.
- When the setting values have been changed, save the setting value by "Save Set Values" on the control command.
Turning OFF the power, resetting, or changing the operation mode without performing "Save Set Values" will return to the setting value that existed before change.



When configuring settings that specify ASCII code for the setting value, be aware of the following points.

- **NUL** (00H) cannot be used as a setting value.
- The characters up to the first **NUL** (00H) are considered the data and any data after that is not valid.

Setting value (hex) of bold face is default value (Setting at the time of factory shipments).

Item	Sub item	Address (hex)	Size (dec)	Default (hex)	Setting value (hex)	Remarks
RS-232 setting	Communication speed	0100	1	03	00 : 1,200bps 01 : 2,400bps 02 : 4,800bps 03 : 9,600bps 04 : 19,200bps 05 : 38,400bps 06 : 57,600bps 07 : 115,200bps 0a : 600bps	After saving, the settings are reflected when the power is turned on, the WB2F is reset, or the operation mode is changed.
	Data length	0101	1	01	00 : 7bits 01 : 8bits	
	Parity	0102	1	01	00 : NONE 01 : EVEN 02 : ODD	
	Stop bits	0103	1	00	00 : 1bit 01 : 2bits	
	Flow control	0104	1	00	00 : NONE 01 : CTS/RTS	
PLC Connection	Function enabled	2200	1	00	00 : Disabled 01 : Enabled	If enabled, it will begin the process to establish a connection with connected external devices at start up. New settings will be reflected after saving and resetting the device.
	Protocol Select	2201	1	00	00 : MC Protocol Format 4 4C (Q,L Series)	Select the communication protocol of the external device that is to be connected to the WB2F.
	Monitoring cycle	2202	1	0A	01 - FF : Setting Value × 10ms (10ms to 2,550ms)	Configure the monitoring interval for the special area.
	Timeout	2203	1	14	01 - FF : Setting Value × 10ms (10ms to 2,550ms)	Configures response timeout from a PLC.

Item	Sub item	Address (hex)	Size (dec)	Default (hex)	Setting value (hex)	Remarks
PLC Connection	Retry Count	2204	1	05	01 - FF : Times	Sets the number of command retransmissions to a PLC.
	Symbol data storage endian	2205	1	00	00 : Lower→Upper 01 : Upper→Lower	To configure the order of stocked data in data memory of PLC.
	Reserved	2206	1	-	-	
	Reserved	2207	1	-	-	
	Special Area Start Address	2208	4	00	00000000 - FFFFFFFF : Special Area Start Address	When configuring the settings ensure that the special area and the scanner information area do not overlap. The special area requires 4 words (8 bytes) of data memory.
		2209		00		
		220A		00		
		220B		00		
	Scanner Information Area Start Address	220C	4	10	00000000 - FFFFFFFF : Scanner Information Area Start Address	
		220D		00		
		220E		00		
		220F		00		
	Reserved	2210-221F	16	-	-	
	Protocol Parameter [0]	2220	2	0000	0000 - FFFF : Protocol Parameter	The meaning of the setting depends on each protocol selected. For details, refer to  [3 Setting and Wiring] on page 3-1.
		2221				
	Protocol Parameter [1]	2222	2	0000	0000 - FFFF : Protocol Parameter	
		2223				
	Protocol Parameter [2]	2224	2	0000	0000 - FFFF : Protocol Parameter	
		2225				
	Protocol Parameter [3]	2226	2	0000	0000 - FFFF : Protocol Parameter	
		2227				
	Protocol Parameter [4]	2228	2	0000	0000 - FFFF : Protocol Parameter	
		2229				
	Protocol Parameter [5]	222A	2	0000	0000 - FFFF : Protocol Parameter	
		222B				
	Protocol Parameter [6]	222C	2	0000	0000 - FFFF : Protocol parameter	
		222D				
	Protocol Parameter [7]	222E	2	0000	0000 - FFFF : Protocol Parameter	
		222F				
Protocol Parameter [8]	2230	2	0000	0000 - FFFF : Protocol Parameter		
	2231					
Protocol Parameter [9]	2232	2	0000	0000 - FFFF : Protocol Parameter		
	2233					
Protocol Parameter [10]	2234	2	0000	0000 - FFFF : Protocol Parameter		
	2235					
Protocol Parameter [11]	2236	2	0000	0000 - FFFF : Protocol parameter		
	2237					
Protocol Parameter [12]	2238	2	0000	0000 - FFFF : Protocol Parameter		
	2239					
Protocol Parameter [13]	223A	2	0000	0000 - FFFF : Protocol Parameter		
	223B					
Protocol Parameter [14]	223C	2	0000	0000 - FFFF : Protocol Parameter		
	223D					
Protocol Parameter [15]	223E	2	0000	0000 - FFFF : Protocol Parameter		
	223F					

2 Operation Specifications

This chapter describes the operation specification of the PLC connection.

2.1 Overview

The WB2F periodically reads the PLC data memory. When the data memory which is being read has any change, the function assigned to the data memory is performed.

This mechanism allows to perform each function of the WB2F only by setting the data memory of PLC to the specified value.

2.2 Assigning Data Memory

The WB2F performs reading and writing to the “Special area” and the “Scanner Information Area” assigned to the PLC data memory. When using this function, set where to assign these two areas in the data memory. For details of the setting, refer to  [\[1.5 Setting Parameters \(WB2F\)\]](#) on page 1-3.

2.3 Special Area

With the special memory area starting address as a header, the following functions shown in the table below are assigned to the data memory. By setting the corresponding bit of the corresponding address to "1", each function can be performed. The WB2F performs the requested function, and then performs zero clear of the special area.

The zero clear after the function is executed targets not only the corresponding bit of the corresponding address, but the special area entirely.

Address (OFFSET)	bit	Function	Contents
0	0	PLC Connection end	Ends the PLC Connection.
	1 - 7	Reserved	
	8	Symbol read stop	Stops the symbol reading
	9	Symbol read start	Starts the symbol reading.
	10 - 15	Reserved	
1	0	OK Output OFF	Stops the OK Output.
	1	OK Output ON	Starts the OK Output (the operation logic and operation time follows the setting value.)
	2	NG Output OFF	Stops the NG Output.
	3	NG Output ON	Starts the NG Output (the operation logic and operation time follows the setting value.)
	4 - 7	Reserved	
	8	Status LED (Red) OFF	Sets the Status LED (Red) to the OFF state.
	9	Status LED (Red) ON	Sets the Status LED (Red) to the ON state (the lighting pattern and the lighting time follows the setting value.)
	10	Status LED (Orange) OFF	Sets the Status LED (Orange) to OFF state.
	11	Status LED (Orange) ON	Sets the Status LED (Orange) to ON state (the lighting pattern and the lighting time follows the setting value.)
	12	Status LED (Green) OFF	Sets the Status LED (Green) to OFF state.
	13	Status LED (Green) ON	Sets the Status LED (Green) to ON state (the lighting pattern and the lighting time follows the setting value.)
	14	Reserved	
	15	Reserved	
2	0-15	Reserved	
3	0-15	Reserved	

When multiple bits are set to 1 at the same time, the lowest one is preferably executed for both address and bit. The other functions are ignored.

e.g. When the following three bits are set to 1 at the same time:

- [Bit 8 of Address 0]
- [Bit 9 of Address 0]
- [Bit 0 of Address 1]

The function only assigned to Bit 8 of Address 0 is executed.

e.g. When the following three bits are set to 1 at the same time:

- [Bit 0 of Address 0]
- [Bit 9 of Address 0]
- [Bit 0 of Address 1]

The function only assigned to Bit 0 of Address 0 is executed.

2.4 Scanner Information Area

With the scanner information area starting address as a header, the functions shown in the table below are assigned to the data memory of PLC. The WB2F writes the symbol data and the data length in the scanner information area.

Address (OFFSET)	bit	Function	Contents
0	0 - 15	Data length	Writes the data length of the symbol data.
1	0 - 7	Data [0]	Writes the read symbol data. The storage order of the symbol data follows the setting values.
	8 - 15	Data [1]	
2	0 - 7	Data [2]	
	8 - 15	Data [3]	
3	0 - 7	Data [4]	
	8 - 15	Data [5]	
⋮	⋮	⋮	



The symbol data quantity is variable. Assure an adequate area of expected data length or more.

e.g. Storage example to the scanner information area

The below shows an example of storing data into the scanner information area.

The setting of the symbol data storage order can change the storage order to the data memory.

[Condition]

Scanner information area starting address: 100

Data memory Data length: 16 bits

Symbol data: "ABCDEFGHI[CR][LF]" 11 bytes

Position	0	1	2	3	4	5	6	7	8	9	10
ASCII	A	B	C	D	E	F	G	H	I	[CR]	[LF]
HEX	41H	42H	43H	44H	45H	46H	47H	48H	49H	0DH	0AH

- [Storing image] (Symbol data storing order: Lower→Upper)

Address	Upper byte	Lower byte	Remarks
100	000BH		<- Number of symbol data: 11 bytes
101	42H	41H	<- Stored in the order of lower byte and upper byte.
102	44H	43H	
103	46H	45H	
104	48H	47H	
105	0DH	49H	
106	00H	0AH	<- The upper byte is padded with 00H .

- [Storage image] (symbol data storage order:Upper→Lower)

Address	Upper byte	Lower byte	Remarks
100	000BH		<- Number of symbol data: 11 bytes
101	41H	42H	<- Stored in the order of upper byte and lower byte.
102	43H	44H	
103	45H	46H	
104	47H	48H	
105	49H	0DH	
106	0AH	00H	<- The lower byte is padded with 00H.

2.5 Start and End

The PLC connection can be started and ended in the following conditions:

Start condition

With Address "2200 (PLC connection – function Enabled) in the setting parameter of the WB2F set and stored to "01 (Enable), turn the power from OFF to ON.



When the start condition is established, the Status LED (Green) starts flashing.
After blinking stops, the PLC connection starts.

End condition

- Depress the READ/ENTER button of the WB2F for 5 seconds.
- Set the PLC Connection End Bit in the Special Area of the PLC data memory to "1".



When the end condition is established, the Status LED (Red) starts blinking.
After blinking stops, the PLC connection ends.

2.6 Operation Sequence

The WB2F repeatedly performs the following four operations:

- 1** When symbol reading is completed, the writing of symbol data to the scanner information area is performed.
- 2** When the execution of the requested function is completed, the zero clear of the special area is performed.
- 3** When the bit in the special area is 1, and there is a request of function execution, the assigned function is performed.
- 4** If the above 1 to 3 is not applicable, reading of the special area is performed.

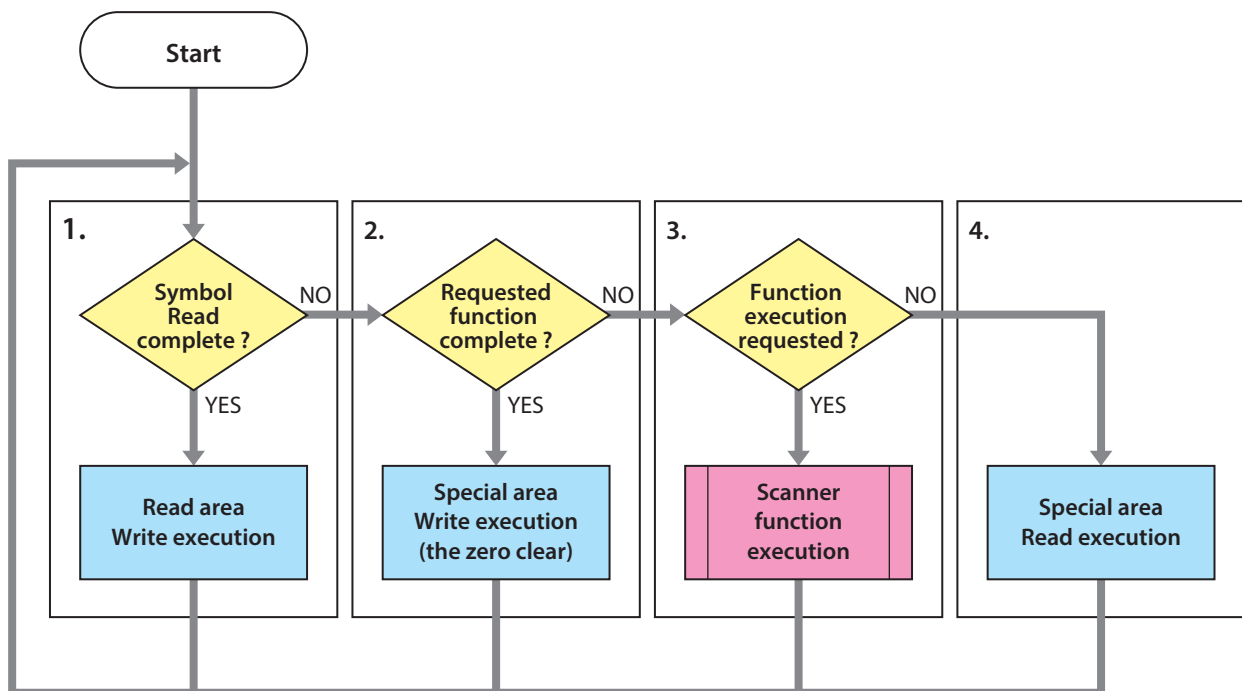

When creating a PLC program, note the following:

- (1) After checking that the special area is all "0", make the bit in the special area to "1".
(On the PLC program, even when the different bit is 1 in the different timing, it is regarded that plural bits are set to 1 at the same time depending on the communication timing.)
- (2) Before requesting to start reading the symbol, perform zero clear for the scanner information area (data length).
- (3) If the connection between the WB2F and PLC cannot be established after the specified times of retry, the process is transferred to the "Special Area Read".
- (4) When the bit in the special area is "1" when the communication is restored, the corresponding function is performed.
(Even for the function requested by the PLC program before the communication was unsuccessful, when the bit in the special area is "1" when the communication is established, the function is performed.)

e.g. PLC program and access to the data memory of WB2F

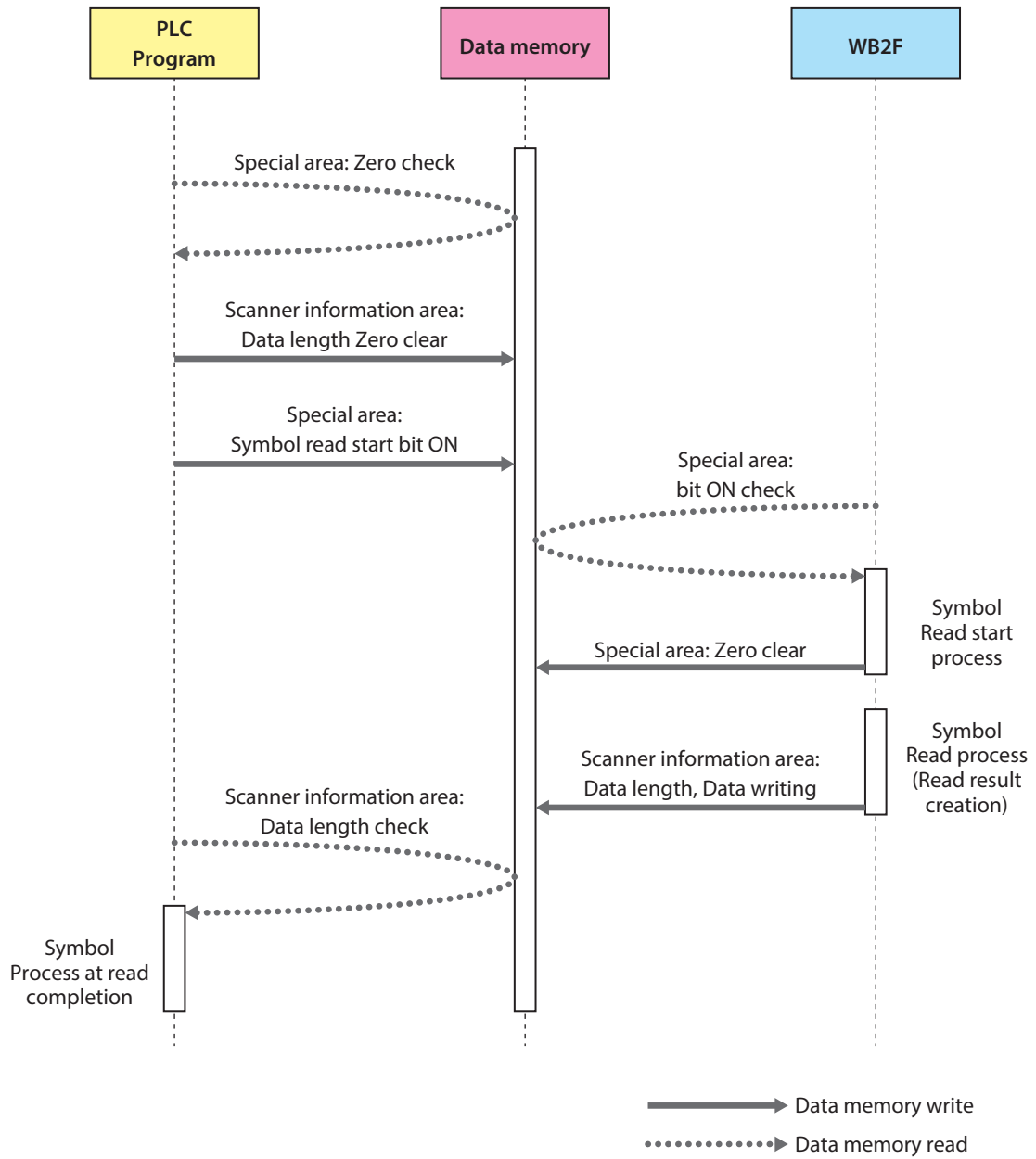

3 Setting and Wiring

This chapter describes the connection between the WB2F and PLC.

3.1 Connection to PLC

There are two methods: the first method is to use the communication unit, and the second method is not to use the communication unit.

Using the communication unit:

Connects the WB2F, communication unit, and PLC. The communication unit is used as an RS-232 relay device or RS-422 converter. Perform setting of the WB2F, communication unit, and PLC to perform RS-232/RS-422 connection.

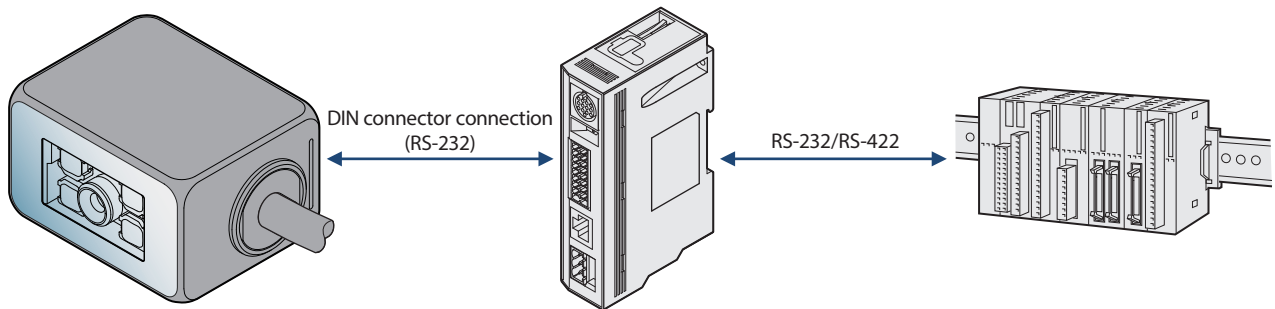

When not using the communication unit:

Connects the WB2F and PLC.

Perform setting of the WB2F and PLC, and connect RS-232.

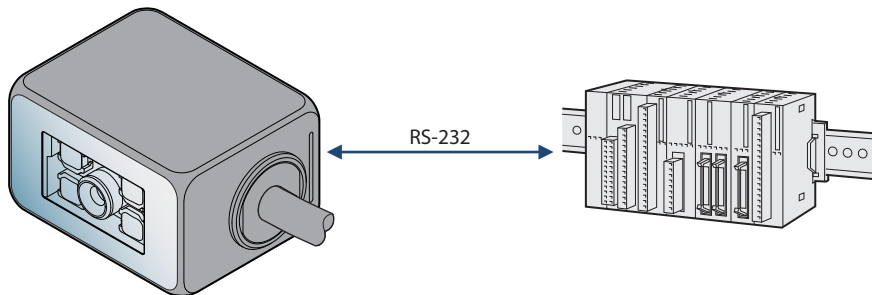

For specifications and setup details for the WB2F, the communication unit, and the PLC, refer to each respective manual.

3.2 MC Protocol Setting

3.2.1 Overview

The MC protocol performs data sending/receiving between the WB2F and the MELSEC sequencer.

The MC protocol is the abbreviation of "MELSEC Communication Protocol," which is the communication protocol for the MELSEC sequencer allowing the sequencer to communicate with external devices (such as the WB2F)

The WB2F can send/receive the data to/from the MC protocol supporting devices in the following conditions:

Protocol	Format 4, 4C frame, Check sum
Series supported *1	MELSEC iQ-R/iQ-F/Q/L series
Connection method	RS-232/RS-422
Data memory	Data register

*1 For the details of supporting devices, refer to [\[1.4 Applicable PLC\]](#) on page 1-2.

3.2.2 WB2F Setting examples

To perform the data send/receive with the MELSEC sequencer, the setting of the RS-232 of the WB2F as well as the PLC connection is necessary.

When selecting the MC protocol, the protocol parameters [0] to [15] means the following setting respectively.

Protocol Parameter [0]	Station No.
Protocol Parameter [1]	Network No.
Protocol Parameter [2]	PC No.
Protocol Parameter [3]	I/O No. of the unit requested
Protocol Parameter [4]	Station No. of the unit requested
Protocol Parameter [5]	Local station No.
Protocol Parameter [6] to [15]	Not used

Here describes the setting examples of the WB2F:

Item	Sub Item	MC protocol Parameter	Address (hex)	Size (dec)	Setting example (hex)	Remarks
RS-232 settings	Communication speed		0100	1	03	03 : 9,600bps
	Data length		0101	1	01	01 : 8bits
	Parity		0102	1	01	01 : EVEN
	Stop bits		0103	1	00	00 : 1bit
	Flow control		0104	1	00	00 : NONE
PLC Con- nection	Function enabled		2200	1	01	01 : Enabled
	Protocol Select		2201	1	00	00 : MC Protocol Format4 4C(Q,L Series)
	Monitoring cycle		2202	1	0A	0A : 10 × 10ms (100ms)
	Timeout		2203	1	14	14 : 20 × 100ms (2,000ms)
	Retry Count		2204	1	05	05 : 5 times
	Symbol data storage endian		2205	1	00	00 : Lower→Upper
	Special Area Start Address		2208	4	00	00000000 : D00000
			2209		00	
			220A		00	
			220B		00	
	Scanner Information Area Start Address		220C	4	10	00000010 : D000016
			220D		00	
			220E		00	
			220F		00	
	Protocol Parameter [0]	Station No.	2220	2	0000	0000 : Station No. 0
			2221			
	Protocol Parameter [1]	Network No.	2222	2	0000	0000 : Network No. 00
2223						
Protocol Parameter [2]	PC No.	2224	2	00FF	00FF : PC No. FF	
		2225				
Protocol Parameter [3]	I/O No. of the unit requested	2226	2	03FF	03FF : I/O No. of the unit requested 03FF	
		2227				
Protocol Parameter [4]	Station No. of the unit requested	2228	2	0000	0000 : Station No. of the unit requested 00	
		2229				
Protocol Parameter [5]	Local station No.	222A	2	0000	0000 : Local station No. 00	
		222B				



The protocol parameter with the MC protocol set means that the parameter is named with the name of MC protocol component.

3.2.3 Communication unit setting example (WB9Z-CU100)

The following table shows the setting example of the communication unit.

Item	Sub Item	Address (hex)	Size (dec)	Setting example (hex)	Remarks
RS-232 setting	Communication speed	8100	1	03	03 : 9,600bps
	Data length	8101	1	01	01 : 8bits
	Parity	8102	1	01	01 : EVEN
	Stop bits	8103	1	00	00 : 1bit
	Flow control	8104	1	00	00 : NONE

3.2.4 PLC Setting example

The following table shows the setting example of the serial communication unit, QJ71C24N.

	Parameter	Setting example	Remarks
Transmission setting	Operation setting	Independent	
	Data Bit	8	Align with the setting for WB2F.
	Parity Bit	Exist	Align with the setting for WB2F.
	Even/odd parity	Even	Align with the setting for WB2F.
	Stop bit	1	Align with the setting for WB2F.
	Sum check code	Exist	
	Online Change	Enable	
	Setting modifications	Enable	
	Communication rate setting	9,600bps	Align with the setting for WB2F.
	Communication protocol setting	MC protocol (Format 4)	
	Station number setting (0 to 31)	0	Align with the setting for WB2F.

The above setting is available by GX Works2. Here is the step (Connect the WB2F to CH1).

In the Navigation window, double click [Project], [Intelligent Function Unit], [0020:QJ71C24N], [Switch Setting], to open the Switch setting window. Perform setting of the channel (CH) as in the following figure.

The screenshot shows the GX Works2 interface. On the left, the 'Navigation' window displays a tree view of the project structure. Under 'Intelligent Function Module', '0020:QJ71C24N' is expanded, and 'Switch Setting' is highlighted with a red box. A red arrow points from this box to the 'Switch Setting' dialog box on the right.

The 'Switch Setting 0020:QJ71C24N' dialog box contains a table with the following data:

Item	CH1	CH2
Operation setting	Independent	Independent
Data Bit	8	8
Parity Bit	Exist	Exist
Even/odd parity	Even	Even
Stop bit	1	1
Sum check code	Exist	Exist
Online Change	Enable	Enable
Setting modifications	Enable	Enable
Communication rate setting	9600bps	300bps
Communication protocol setting	MC protocol (Format 4)	MC protocol (Format 4)
Station number setting (0 to 31)	0	

Below the table, the following text is displayed:

The following setting is available for product information 10122000000000-B or later.
 Communication protocol setting
 - Predefined protocol

* This dialog setting is linked to the Switch Setting of the PLC parameter.
 Default value will be shown in the dialog
 if the Switch Setting of the PLC parameter contains an out-of-range value.

At the bottom of the dialog, there are 'OK' and 'Cancel' buttons.

3.2.5 Wiring example

The following figure shows the wiring example of a QJ71C24N, a communication unit (WB9Z-CU100), and a WB2F (WB2F-100S1B).

Perform wiring by referring to the figure. During wiring, turn OFF the power.

e.g. Wiring of QJ71C24N (CH1) and the communication unit (WB9Z-CU100) using RS-232

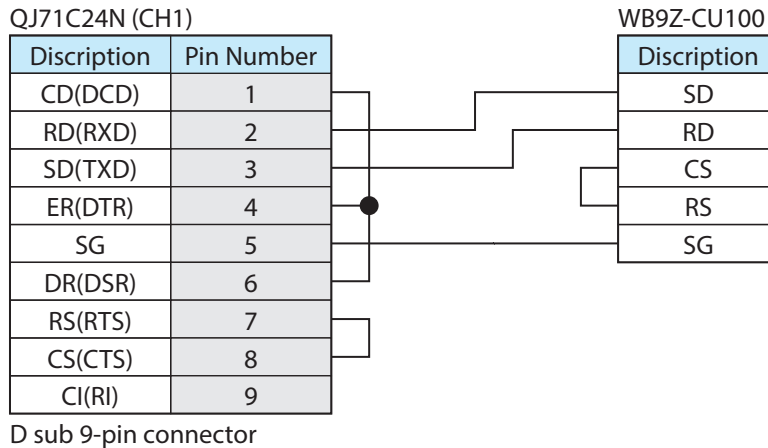

e.g. Wiring of QJ71C24N (CH2) and the communication unit (WB9Z-CU100) using RS-422

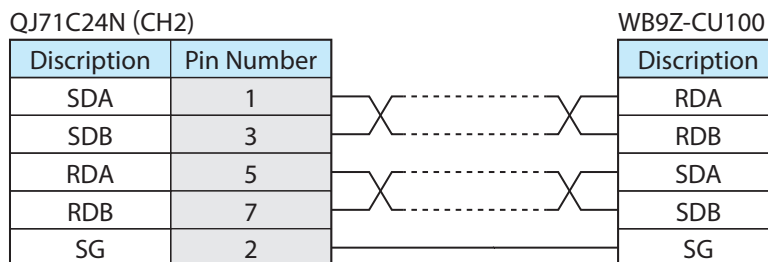

e.g. Wiring of QJ71C24N (CH1) and WB2F (WB2F-100S1B) using RS-232

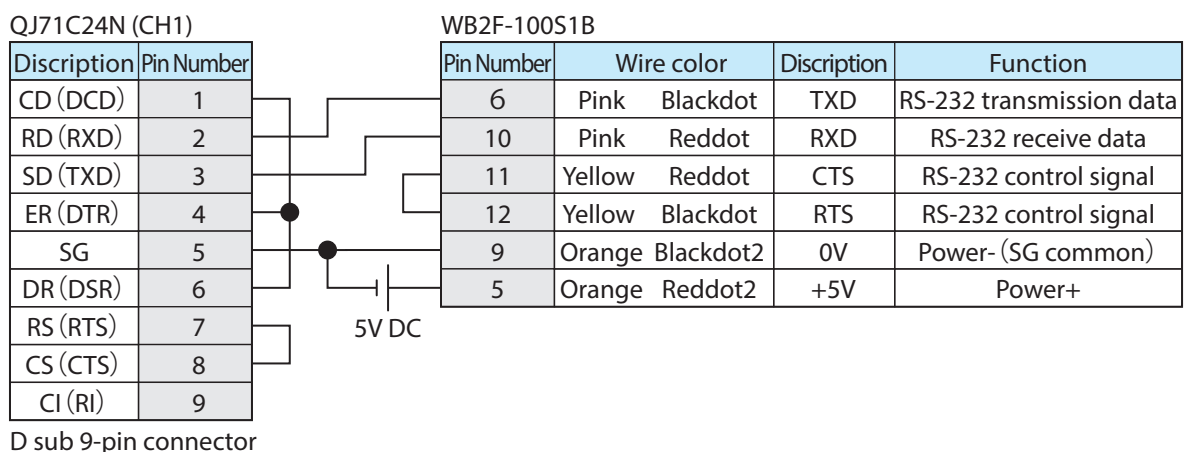

Caution

Never reverse the power connections or else damage may result.

When wiring, be sure to read the User's Manual of the WB2F and of the communication unit in advance.

Index

A

Applicable Models	1-2
Applicable PLC.....	1-2
Assigning Data Memory	2-1

C

Connection to PLC.....	3-1
------------------------	-----

L

Limitation.....	1-2
-----------------	-----

M

MC Protocol Setting	
Communication unit setting example	3-4
Overview.....	3-2
PLC Setting example.....	3-5
WB2F Setting examples	3-2
Wiring example.....	3-6

O

Operation Sequence.....	2-7
Operation Specifications.....	2-1
Overview.....	2-1

P

PLC Connection	1-1
----------------------	-----

S

Scanner Information Area.....	2-4
Setting and Wiring.....	3-1
Setting Parameters (WB2F)	1-3
Special Area.....	2-2
Start and End.....	2-6

Revision history

Edition	Published	Revised content	
		Page	Points
1st Edition	2017.3	-	
2nd Edition	2018.6	1-2	Applicable PLC Correspondence Table updated
		3-6	Wiring Example RS-422 connection added

WB2F 2D Code Scanner

PLC Connection User's Manual

- B-1960(1)
- Published: JUNE 2018 2nd edition
- 6-64, Nishi-Miyahara 2-Chome, Yodogawa-ku, Osaka, Japan

IDEC CORPORATION © 2017 IDEC CORPORATION All Rights Reserved.

- The specifications and content in this manual may be changed without prior notification.
- Reproduction of this manual without prior permission is prohibited. All rights reserved.

IDEC CORPORATION

 www.idec.com

Head Office

6-64, Nishi-Miyahara-2-Chome, Yodogawa-ku, Osaka 532-0004, Japan

USA	IDEC Corporation	Tel: +1-408-747-0550	opencontact@idec.com	Hong Kong	IDEC Izumi (H.K.) Co., Ltd.	Tel: +852-2803-8989	info@hk.idec.com
Australia	IDEC Australia Pty. Ltd.	Tel: +61-3-8523-5900	sales@au.idec.com	China/Shanghai	IDEC (Shanghai) Corporation	Tel: +86-21-6135-1515	idec@cn.idec.com
Germany	APEM GmbH	Tel: +49-40-25 30 54 - 0	service@eu.idec.com	China/Shenzen	IDEC (Shenzen) Corporation	Tel: +86-755-8356-2977	idec@cn.idec.com
Singapore	IDEC Izumi Asia Pte. Ltd.	Tel: +65-6746-1155	info@sg.idec.com	China/Beijing	IDEC (Beijing) Corporation	Tel: +86-10-6581-6131	idec@cn.idec.com
Thailand	IDEC Asia (Thailand) Co., Ltd	Tel: +66-2-392-9765	sales@th.idec.com	Japan	IDEC Corporation	Tel: +81-6-6398-2527	marketing@idec.co.jp
Taiwan	IDEC Taiwan Corporation	Tel: +886-2-2698-3929	service@tw.idec.com				

Specifications and other descriptions in this brochure are subject to change without notice.
2017 IDEC Corporation, All Rights Reserved.

B-1960(1) JUNE 2018





IDEC CORPORATION