

High Performance Compact AC Drive

Doesa VF1A series



PRODUCT DESCRIPTION

With robust features and a compact design, the three-phase 380 to 480V AC Doesa VF1A Series AC drive works with a variety of applications from fan and pump to specialized machinery. Made to last design, these high-performance AC drives come with enhanced functionality built-in as standard. This includes PID, Mechanical Brake control, Torque control, Customizable Logic, STO functional safety, and RS-485 Modbus communication.

KEY FEATURES

- Customizable logic
- Functional safety
- Superior flexibility
- Built-in advanced features
- Durable design

PART NUMBER CONFIGURATION

VF1A - G 02A1 S 4

1 2 3 4 5

1

Code	Series name
VF1A	Doesa VF1A series

2

Code	Applicable tiled
G	General purpose

3

Code	Amps
02A1	2.1
04A1	4.1
05A5	5.5
06A9	6.9
12A0	12.0
21A5	21.5
28A5	28.5
37A0	37.0
44A0	44.0
59A0	59.0
72A0	72.0
85A0	85.0
105A	105.0
139A	139.0

4

Code	Applicable tiled
S	Basic type (No built-in EMC filter)

5

Code	Power supply
4	Three-phase 400V



PART NUMBERS

Part Numbers	Frame	ND		HD		HND		HHD	
		Amps	kW (HP)	Amps	kW (HP)	Amps	kW (HP)	Amps	kW (HP)
VF1A-G02A1S4	B1	2.1	0.75 (1)	1.8	0.75 (1)	1.8	0.75 (1)	1.5	0.4 (0.5)
VF1A-G04A1S4		4.1	1.1 (1.5)	3.4	1.1 (1.5)	3.4	1.1 (1.5)	2.5	0.75 (1)
VF1A-G05A5S4		5.5	2.2 (3)	5.0	2.2 (3)	5.0	2.2 (3)	4.2	1.5 (2)
VF1A-G06A9S4		6.9	3 (4)	6.3	3 (4)	6.3	3 (4)	5.5	2.2 (3)
VF1A-G12A0S4	B2	12.0	5.5 (7.5)	11.1	5.5 (7.5)	11.1	5.5 (7.5)	9.0	3.7 (5)
VF1A-G21A5S4	B3	21.5	11 (15)	17.5	7.5 (10)	17.5	7.5 (10)	13.0	5.5 (7.5)
VF1A-G28A5S4		28.5	15 (20)	23.0	11 (15)	23.0	11 (15)	18.0	7.5 (10)
VF1A-G37A0S4	B4	37.0	18.5 (25)	31.0	15 (20)	31.0	15 (20)	24.0	11 (15)
VF1A-G44A0S4		44.0	22 (30)	38.0	18.5 (25)	38.0	18.5 (25)	30.0	15 (20)
VF1A-G59A0S4	B5	59.0	30 (40)	45.0	22 (30)	45.0	22 (30)	39.0	18.5 (25)
VF1A-G72A0S4		72.0	37 (50)	60.0	30 (40)	60.0	30 (40)	45.0	22 (30)
VF1A-G85A0S4	B6	85.0	45 (60)	75.0	37 (50)	75.0	37 (50)	60.0	30 (40)
VF1A-G105AS4		105.0	55 (75)	91.0	45 (60)	91.0	45 (60)	75.0	37 (50)
VF1A-G139AS4	B7	139.0	75 (100)	112.0	55 (75)	112.0	55 (75)	91.0	45 (60)

OPTIONAL PART NUMBERS

Part Number	Description
VF1A-PH1	Keypad The keypad for the USB connection with the PC
VF1A-DIO	Digital I/O interface card DI: The frequency set-point can be given by 8,12 bits and BCD code(0 to 99.9/0 to 999) and extended 13 digital inputs are available mounting this card in the inverter. DO: The monitoring with 8bit binary code and the digital outputs (extended 8 point) are available.
VF1A-AIO	Analog I/O interface card It enables the inverter to input analog set-points to the inverter and output analog monitors from the inverter
VF1A-RS485	RS-485 communication card This card provides two RJ-45 connectors for multi-drop connection.
VF1A-PG1	PG interface (5V) card Speed control, position control and synchronous drive are available mounting this card in the inverter. Open collector (Pull-up resistor: 620Ω) : 30kHz. Complementary (Totem-pole push-pull): 30kHz Voltage output: 5V
VF1A-PG3	PG interface (12V/15V) card Speed control, position control and synchronous drive are available mounting this card in the inverter. Open collector (Pull-up resistor: 2350Ω): 30kHz. Complementary (Totem-pole push-pull): 100kHz Voltage output: 12V/15V
VF1A-ADP1	Mounting Adapter for optional communication card The adapter is mounted on the front side of the inverter. It is used from 02A1 to 44A0 type.
VF1A-ADP2	Mounting Adapter for optional communication card The adapter is mounted inside of the inverter. It is used from 59A0 to 72A0.
VF1A-ADP3	Mounting Adapter for optional communication card The adapter is mounted inside of the inverter. It is used from 85A0 to 139A.

GENERAL SPECIFICATIONS

Type		VF1A-G□□□□S4														
		02A1	04A1	05A5	06A9	12A0	21A5	28A5	37A0	44A0	59A0	72A0	85A0	105A	139A	
Nominal applied motor *1 [kW(HP)]	ND	0.75(1)	1.5(2)	2.2(3)	3.0(4)	5.5(7.5)	11(15)	15(20)	18.5(25)	22(30)	30(40)	37(50)	45(60)	55(75)	75(100)	
	HD	0.75(1)	1.1(1.5)	2.2(3)	3.0(4)	5.5(7.5)	7.5(10)	11(15)	15(20)	18.5(25)	22(30)	30(40)	37(50)	45(60)	55(75)	
	HND	0.75(1)	1.1(1.5)	2.2(3)	3.0(4)*9	5.5(7.5)*9	7.5(10)	11(15)	15(20)	18.5(25)	22(30)	30(40)	37(50)	45(60)	55(75)	
	HHD	0.4(1/2)	0.75(1)	1.5(2)	2.2(3)	3.7(5)	5.5(7.5)	7.5(10)	11(15)	15(20)	18.5(25)	22(30)	30(40)	37(50)	45(60)	
Output ratings	Rated capacity [kVA] *2	ND	1.6	3.1	4.2	5.3	9.1	16	22	28	34	45	55	65	80	106
		HD	1.4	2.6	3.8	4.8	8.5	13	18	24	29	34	46	57	69	85
		HND	1.4	2.6	3.8	4.8*9	8.5*9	13	18	24	29	34	46	57	69	85
		HHD	1.1	1.9	3.2	4.2	6.9	9.9	14	18	23	30	34	46	57	69
	Rated voltage [V] *3		Three-phase 380 to 480V (With AVR)													
	Rated current [A] *4	ND	2.1	4.1	5.5	6.9	12	21.5	28.5	37.0	44.0	59.0	72.0	85.0	105	139
		HD	1.8	3.4	5.0	6.3	11.1	17.5	23.0	31.0	38.0	45.0	60.0	75.0	91.0	112
		HND	1.8	3.4	5.0	6.3*9	11.1*9	17.5	23.0	31.0	38.0	45.0	60.0	75.0	91.0	112
		HHD	1.5	2.5	4.2	5.5	9.0	13.0	18.0	24.0	30.0	39.0	45.0	60.0	75.0	91.0
	Overload capability	ND, HND	120% of nominal current for 1min													
HD		150% of nominal current for 1min														
HHD		150% of nominal current for 1min or 200% of nominal current for 0.5s														
Main power supply		Three-phase 380 to 480V (With AVR)											Three-phase 380 to 480V, 50/60Hz			
Voltage/frequency variations		Voltage: +10 to -15% (Voltage unbalance:2% or less *8, Frequency: +5 to -5%)														
Input ratings	Rated current without DCR *5 [A]	ND	2.7	4.8	7.3	11.3	16.8	33.0	43.8	52.3	60.6	77.9	94.3	114	140	-
		HD	2.7	3.9	7.3	11.3	16.8	23.2	33.0	43.8	52.3	60.6	77.9	94.3	114	140
		HND	2.7	3.9	7.3	11.3*9	16.8*9	23.2	33.0	43.8	52.3	60.6	77.9	94.3	114	140
		HHD	1.7	3.1	5.9	8.2	13.0	17.3	23.2	33.0	43.8	52.3	60.6	77.9	94.3	114
	Rated current with DCR *5 [A]	ND	1.5	2.9	4.2	5.8	10.1	21.1	28.8	35.5	42.2	57.0	68.5	83.2	102	138
		HD	1.5	2.1	4.2	5.8	10.1	14.4	21.1	28.8	35.5	42.2	57.0	68.5	83.2	102
		HND	1.5	2.1	4.2	5.8*9	10.1*9	14.4	21.1	28.8	35.5	42.2	57.0	68.5	83.2	102
		HHD	0.85	1.6	3.0	4.4	7.3	10.6	14.4	21.1	28.8	35.5	42.2	57.0	68.5	83.2
	Required power supply capacity *6 [kVA]	ND	1.1	2.1	3.0	4.1	7.0	15	20	25	29	39	47	58	71	96
		HD	1.1	1.5	3.0	4.1	7.0	10	15	20	25	29	39	47	58	71
HND		1.1	1.5	3.0	4.1*9	7.0*9	10	15	20	25	29	39	47	58	71	
HHD		0.6	1.2	2.1	3.1	5.1	7.3	10	15	20	25	29	39	47	58	
Braking torque *7 [%]	ND	53%	50%	48%	29%	27%	12%								5 to 9%	
	HD	53%	68%	48%	29%	27%	15%								7 to 12%	
	HND	53%	68%	48%	29%*9	27%*9	15%								7 to 12%	
	HHD	100%		70%	40%		20%								10 to 15%	
Braking	DC braking	Starting frequency: 0.0 to 60.0Hz, Braking time: 0.0 to 30.0s, Braking level: 0 to 60% (ND spec.), 0 to 80% (HD/HND spec.), 0 to 100% (HHD spec.) of nominal current														
	Braking chopper	Built-in											Option			
	Minimum connectable resistance [ohm]	200			160			130	80	60	40	34.4	16	-	-	-
	Braking resistor	Option														
DC reactor (DCR)		Option														
Enclosure (IEC60529)		IP20, UL open type											IP00, UL open type			
Cooling method		Natural cooling			Fan cooling											
Mass [kg]		1.2	1.5	1.5	1.6	1.9	5.0	5.0	8.0	9.0	9.5	10	25	26	30	

Note:

- *1 At the selection of the inverter rating, consider not only the rating capacity(kW) is enough but also inverter output current is larger than selected the motor's nominal current.
- *2 Rated capacity is calculated by assuming the output rated voltage as 440 V.
- *3 The output voltage cannot exceed the power supply voltage.
- *4 When the carrier frequency (F26) is set to below value or higher, the inverter is sure to be necessary to derate their nominal current.
HHD spec.---type 0002 to 0012 : 8kHz, type 0021 to 0139 : 10kHz
HND spec.---type 0002 to 0012 : 8kHz, type 0021 to 0059 : 10kHz, type 0072 to 0139 : 6kHz : 4kHz HD,ND spec.---All type : 4kHz
The rated output current at HD/ND spec. is decreased 2% for every 1 °C (1.8 °F) when ambient temperature is +40 °C (+104 °F) or more.
- *5 The value is calculated assuming that the inverter is connected with a power supply with the capacity of 500 kVA (or 10 times the inverter capacity if the inverter capacity exceeds 50 kVA) and %X is 5%. Be sure to use the DCR when applicable motor capacity is 75kW or above.
- *6 Obtained when a DC reactor (DCR) is used.
- *7 Average braking torque for the motor running alone. (It varies with the efficiency of the motor.)
- *8 Voltage unbalance (%) =(Max. voltage (V) - Min. voltage (V))/Three -phase average voltage (V) × 67 (IEC 61800 - 3) If this value is 2 to 3%, use an optional AC reactor (ACR).
- *9 HND spec. of the type 0007 and 0012: allowable ambient temperature 40 °C (+104 °F) or less. The rated output current at HND spec. is decreased 1% for every 1 °C (1.8 °F) when ambient temperature is +40 °C (+104 °F) or more.

COMMON SPECIFICATIONS

Item	Explanation	Remarks	
Output	Maximum frequency	HHD/HND/HD mode: 25 to 500 Hz variable (under V/f control, Magnetic pole position sensorless vector control) (Up to 200 Hz in case of under vector control with speed sensor) ND mode: 25 to 120 Hz (under any drive control)	IMPG-VC
	Base frequency	25 to 500 Hz variable (in conjunction with the maximum frequency)	
	Starting frequency	0.1 to 60.0 Hz variable (0.0 Hz under vector control with speed sensor)	IMPG-VC
	Carrier frequency	Three phase 400 V class series VF1A-G02A1S4 to VF1A-G59A0S4: <ul style="list-style-type: none"> • 0.75 to 16 kHz variable (HHD/HND/HD spec.) • 0.75 to 10 kHz variable (ND spec.) VF1A-G72A0S4 to VF1A-G139AS4: <ul style="list-style-type: none"> • 0.75 to 16 kHz variable (HHD spec.) • 0.75 to 10 kHz variable (HND/HD spec.) • 0.75 to 6 kHz variable (ND spec.) Note: The carrier frequency may automatically lower depending upon the ambient temperature or the output current to protect the inverter. (The automatic lowering function can be disabled.)	
	Output frequency accuracy (Stability)	<ul style="list-style-type: none"> • Analog setting: $\pm 0.2\%$ of maximum frequency (at $25 \pm 10^\circ\text{C}$) ($77 \pm 18^\circ\text{F}$) • Keypad setting: $\pm 0.01\%$ of maximum frequency (at -10 to $+50^\circ\text{C}$) ($14 \pm 22^\circ\text{F}$) 	
	Frequency setting resolution	<ul style="list-style-type: none"> • Analog setting: 0.05% of maximum frequency • Keypad setting: 0.01 Hz (99.99 Hz or less), 0.1 Hz (100.0 to 500 Hz) • Link setting: 0.005% of maximum frequency or 0.01 Hz (fixed) 	
	Speed control range	<ul style="list-style-type: none"> • 1: 1500 (Minimum speed : Nominal speed, 4P, 1 to 1500 r/min) • 1: 100 (Minimum speed : Nominal speed, 4P, 15 to 1500 r/min) • 1: 10 (Minimum speed : Nominal speed, 6P, 180 to 1800 r/min) 	IMPG-VC IMPG-VF PM-SVC
	Speed control accuracy	<ul style="list-style-type: none"> • Analog setting: $\pm 0.2\%$ of maximum frequency or below (at $25 \pm 10^\circ\text{C}$) ($77 \pm 18^\circ\text{F}$) • Digital setting: $\pm 0.01\%$ of maximum frequency or below (at -10 to $+50^\circ\text{C}$) (14 to 122°F) 	IMPG-VC
Control	Control method	<ul style="list-style-type: none"> • V/f control • Vector control without speed sensor (Dynamic torque vector) • V/f control, with slip compensation • V/f control, with slip sensor (PG option) • V/f Control with speed sensor (+Auto Torque Boost)(PG option) • Vector control with speed sensor (PG option) • Vector control without magnetic pole position sensor 	VF IM-SVC VF with SC IMPG-VF IMPG-ATB IMPG-VC PM-SVC
	Voltage/frequency characteristics	Possible to set 160 to 500 V at base frequency and at maximum output frequency. <ul style="list-style-type: none"> • Non-linear V/f setting (3 points): Free voltage (0 to 500 V) and frequency (0 to 500 Hz) can be set. 	
	Torque boost	<ul style="list-style-type: none"> • Auto torque boost (For constant torque load) • Manual torque boost: Torque boost value can be set between 0.0 and 20.0% • Select application load with the function code. (Variable torque load or constant torque load) 	
	Starting torque	Three phase 400 V class series <ul style="list-style-type: none"> • 200% or above, reference frequency 0.5 Hz (HHD-mode inverters of VF1A-G72A0S4 or below) • 150% or above, reference frequency 0.5 Hz (HHD-mode inverters of VF1A-G85A0S4 or above) • 120% or above, reference frequency 0.5 Hz (HND/ND mode) • 150% or above, reference frequency 0.5 Hz (HD mode) Base frequency 50 Hz, with slip compensation and auto torque boost active	
	Start/stop operation	Keypad: Start and stop with \bigcirc and \bigcirc keys (Standard keypad) Start and stop with \bigcirc/\bigcirc and \bigcirc keys (Optional multi-function keypad) External signals (digital inputs): Forward (Reverse) rotation, stop command (capable of 3-wire operation), coast-to-stop command, external alarm, alarm reset, etc. Link operation: Operation through RS-485 (built-in as standard), or field bus (option) communications link Switching run command: Remote/local switching, link switching	
	Frequency setting	Keypad: Using \bigcirc and \bigcirc keys	
		External potentiometer: Using external frequency command potentiometer. (External resistor of 1 to 5 k Ω 1/2 W)	
		Analog input: 0 to ± 10 VDC (± 5 VDC)/ 0 to $\pm 100\%$ (terminal [12]), 0 to $+10$ VDC ($+5$ VDC)/ 0 to $+100\%$ (terminal [12]) 4 to 20 mA DC/ 0 to $+100\%$ (terminal [C1] (C1 function)) 4 to 20 mA DC/ 0 to $\pm 100\%$ (terminal [C1] (C1 function)) 0 to 20 mA DC/ 0 to $+100\%$ (terminal [C1] (C1 function)) 0 to 20 mA DC/ 0 to $\pm 100\%$ (terminal [C1] (C1 function)) 0 to $+10$ VDC ($+5$ VDC)/ 0 to $+100\%$ (terminal [C1] (V2 function)), 0 to $+10$ VDC ($+5$ VDC)/ 0 to $\pm 100\%$ (terminal [C1] (V2 function))	
UP/DOWN operation: Frequency can be increased or decreased while the digital input signal is ON.			
Multistep frequency: Selectable from 16 different frequencies (step 0 to 15)			
Pattern operation: The inverter runs automatically according to the previously specified run time, rotation direction, acceleration/deceleration time and reference frequency. Up to 7 stages can be specified.			
Link operation: Operation through RS-485 (built-in as standard) or field bus (option) communications link			
Frequency setting: Two types of frequency settings can be switched with an external signal (digital input). Remote/local switching, link switching			
Auxiliary frequency setting: Inputs at terminal [12], [C1] (C1 function) or [C1] (V2 function) can be added to the main setting as auxiliary frequency settings.			

COMMON SPECIFICATIONS

Item	Explanation	Remarks
Frequency setting	Operation at a specified ratio: The ratio can be set by analog input signal. 0 to 10 VDC/0 (4) to 20 mA/0 to 200% (variable)	
	Inverse operation: Switchable from "0 to +10 VDC/0 to 100%" to "+10 to 0 VDC/0 to 100%" for the external command (terminals [12] and [C1] (V2 function)) Switchable from "0 to -10 VDC/0 to -100%" to "-10 to 0 VDC/0 to -100%" for the external command (terminal [12]) Switchable from "4 to +20 mA DC/0 to 100%" to "20 to 4 mA DC/0 to 100%" for the external command (terminal [C1] (C1 function)) Switchable from "0 to +20 mA DC/0 to 100%" to "20 to 0 mA DC/0 to 100%" for the external command (terminal [C1] (C1 function))	
	Pulse train input (standard): Pulse input = Terminal [X5], Rotational direction = general terminal Complementary output: Max. 100 kHz, Open collector output: Max. 30 kHz	
	Pulse train input (option): A PG option card is required. CW/CCW pulse, pulse + rotational direction Complementary output: Max. 100 kHz, Open collector output: Max. 30 kHz	
	Setting range: Between 0.00 and 6000 s Switching: The four types of acceleration/deceleration time can be set or selected individually (switchable during operation). Acceleration/deceleration pattern: Linear acceleration/deceleration, S-curve acceleration/deceleration (weak, arbitrary (with function code)), curvilinear acceleration/deceleration Deceleration mode (coast-to-stop): Shutoff of the run command lets the motor coast to a stop. Acceleration/deceleration time exclusive to jogging (0.00 to 6000 s) Forcible stop deceleration time: Deceleration stop by the forcible stop STOP. During forced stop operation, S-curve acceleration/deceleration is disabled.	
Frequency limiter(Upper limit and lower limit frequencies)	<ul style="list-style-type: none"> Specifies the upper and lower limits in Hz. "Continue to run" or "Decelerate to a stop" selectable when the reference frequency drops below the lower limit. 	
Frequency/PID command bias	<ul style="list-style-type: none"> Bias of reference frequency and PID command can be independently set (setting range: 0 to ±100%). 	
Analog input	<ul style="list-style-type: none"> Gain: Setting range from 0 to 200% Offset: Setting range from -5.0 to +5.0% Filter: Setting range from 0.00 s to 5.00 s Polarity selection (±/+) 	
Jump frequency	<ul style="list-style-type: none"> Three operation points and their common jump width (0 to 30.0 Hz) can be set. 	
Timed operation	The inverter drives the motor for the run time specified from the keypad and stops its output. (Single-cycle operation)	
Jogging operation	<ul style="list-style-type: none"> Operation with key (standard keypad), or key (multi-function keypad), or digital input signal FWD or REV (Exclusive acceleration/deceleration time setting, exclusive frequency setting) 	
Auto-restart after momentary power failure	<ul style="list-style-type: none"> Trip immediately: Trip immediately at the time of power failure. Trip after a recovery from power failure: Coast to a stop at the time of power failure and trip when the power is recovered. Trip after decelerate-to-stop: Deceleration stop at power failure, and trip after stoppage Continue to run: Operation is continued using the load inertia energy. Start at the frequency selected before momentary power failure: Coast-to-stop at power failure and start after power recovery at the frequency selected before momentary stop. Start at starting frequency: Coast-to-stop at power failure and start at the starting frequency after power recovery. Start at the frequency searched at the time of power recovery: Coast-to-stop at power failure, search for the idling motor speed, and restart the motor. 	
Hardware current limiter	Limits the current by hardware to prevent an overcurrent trip from being caused by fast load variation or momentary power failure, which cannot be covered by the software current limiter. This limiter can be canceled.	
Operation by commercial power supply	With commercial power selection commands (SW50, SW60), the inverter outputs 50/60 Hz.	
Slip compensation	<ul style="list-style-type: none"> Compensates for decrease in speed according to the load Possible to set constants for the response of slip compensation. 	
Droop control	<ul style="list-style-type: none"> Decreases the speed according to the load torque. 	
Torque limiter	Control output torque so that output torque is preset limiting value or less. <ul style="list-style-type: none"> Switchable between 1st and 2nd torque limit values 	
Torque current limiter	<ul style="list-style-type: none"> Torque limit and Torque current limit are selectable. Torque limit by analog input. 	IMPG-VC PM-SVC
Software current limiter	Automatically reduces the frequency so that the output current becomes lower than the preset operation level. This limiter can be canceled.	
Overload stop	If the detected torque or current exceeds the preset value, the inverter decelerates the motor to a stop or causes the motor to coast to a stop.	
PID control	<ul style="list-style-type: none"> PID processor for process control/dancer control Normal operation/inverse operation PID command: Keypad, analog input (from terminals [12], [C1] (C1 function) and [C1] (V2 function)), multistep frequency (3 steps), RS-485 communication PID feedback value: Analog input (from terminals [12], [C1] (C1 function) and [C1] (V2 function)) Alarm output (absolute value alarm, deviation alarm) Low liquid level stop function (pressurized operation possible before low liquid level stop) Anti-reset wind-up function PID output limiter Integration reset/hold 	
Auto search for idling motor speed	The inverter automatically searches for the idling motor speed and starts to drive it without stopping it. Motor parameters require tuning. (Offline tuning)	
Automatic deceleration	<ul style="list-style-type: none"> If the DC link bus voltage or calculated torque exceeds the automatic deceleration level during deceleration, the inverter automatically prolongs the deceleration time to avoid overvoltage trip. (It is possible to select forcible deceleration actuated when the deceleration time becomes three times longer.) If the calculated torque exceeds automatic deceleration level during constant speed operation, the inverter avoids overvoltage trip by increasing the frequency. 	

COMMON SPECIFICATIONS

Item	Explanation	Remarks		
Control	Deceleration characteristic (improved braking capacity)	The motor loss is increased during deceleration to reduce the regenerative energy in the inverter to avoid overvoltage trip.		
	Auto energy saving operation	Controls the output voltage to minimize the total sum of the motor loss and inverter loss.		
	Overload prevention control	If the surrounding temperature or IGBT junction temperature increases due to overload, the inverter lowers the output frequency to avoid overload.		
	Battery/UPS operation	Cancels the undervoltage protection so that the inverter under an undervoltage condition runs the motor with battery/UPS power.		
	Offline tuning	Tunes the motor while the motor is stopped or running, for setting up motor parameters.		
	Online tuning	Controls the motor speed variation caused by the motor temperature rise during running.		
	Cooling fan ON/OFF control	<ul style="list-style-type: none"> • Detects inverter internal temperature and stops cooling fan when the temperature is low. • Possible to output a fan control signal to an external device. 		
	1st to 2nd motor settings	<ul style="list-style-type: none"> • Switchable between two motors It is possible to set the base frequency, rated current, torque boost, and electronic thermal slip compensation as the data for 1st and 2nd motors.		
	Universal DI	Transfers the status of an external digital signal connected with the general-purpose digital input terminal to the host controller.		
	Universal DO	Outputs a digital command signal sent from the host controller to the general-purpose digital output terminal.		
	Universal AO	Outputs an analog command signal sent from the host controller to the analog output terminal.		
	Speed control	<ul style="list-style-type: none"> • Notch filter for vibration control • Selectable among the four set of the auto speed regulator (ASR) parameters. (a PG option card is required.) 	IMPG-VC PM-SVC	
	Line speed control	In a machine such as winder/unwinder, regulates the motor speed to keep the peripheral speed of the spool constant. (a PG option card is required.)	IMPG-VF	
	Positioning control with pulse counter	The positioning control starts from the preset start point and counts the feedback pulses by means of PG card installed in the inverter. The motor can be automatically started decelerating to the creep speed at which the target position can be detected, so that the motor can stop near the position (a PG option card is required).	Excluded IMPG-VC PM-SVC	
	Master-follower operation	Enables synchronous operation of two motors equipped with a pulse generator (PG). (a PG option card is required.)		
	Pre-excitation	Excitation is carried out to create the motor flux before starting the motor. (a PG option card is required.)	IMPG-VC	
	Zero speed control	The motor speed is held to zero by forcibly zeroing the speed command. (a PG option card is required.)	IMPG-VC	
	Servo lock	Stops the motor and holds the motor in the stopped position.(a PG option card is required.)	IMPG-VC	
	Display	DC braking	Applies DC current to the motor at the operation start time or at the time of inverter stop to generate braking torque.	
		Mechanical brake control	<ul style="list-style-type: none"> • Possible to output mechanical brake control signals with the brake ON/OFF timing adjusted by the output current, torque command, output frequency and timer. • Mechanical brake application check input. 	
Torque control		<ul style="list-style-type: none"> • Analog torque/torque current command input • Speed limit function is provided to prevent the motor from becoming out of control. • Torque bias (analog setting, digital setting) (The PG option card is required.) 	IMPG-VC	
Rotation direction control		Select either of reverse or forward rotation prevention.		
Customizable logic interface		Possible to select or connect digital logic circuits or analog operation circuits with digital/analog I/O signals, configure a simple relay sequence, and operate it freely. <ul style="list-style-type: none"> • Logic circuits: (Digital) AND, OR, XOR, flip-flop, detection of rising and falling edges, various counters. (Analog) Addition, subtraction, multiplication, division, limiters, absolute values, sign inversion addition, comparison, maximum value selection, minimum value selection, average values, scale conversion. • Multifunction time: On-delay timer, off-delay timer, pulse train output, etc. Setting range: 0.0 to 9990 s • Input/output signals: Terminal input/output, inverter control functions • Others: Available in 200 steps configured with 2 inputs and 1 output per step. 		
Functions for wiredrawing machines, hoists, and spinning frames		Customizable logic function enables dedicated functions for each application.		
Indicators		Detachable, 7-segment, 4-digit LED, 7 push-buttons (PRG/RESET, FUNC/DATA, UP, DOWN, RUN, STOP, and SHIFT), and 6 LED indicators (KEYPAD CONTROL, Hz, A, kW, X10, and RUN)		
Running/stopping		Speed monitor (reference frequency, output frequency, motor speed, load shaft speed, line speed, and speed indication with percent), output current (A), output voltage (V), calculated torque (%), input power (kW), PID command value, PID feedback amount, PID output, timer values for timed operation (s), load factor (%), and motor output (kW), Torque current [%], Magnetic flux command [%], Analog input monitor, input watt-hour, constant feeding rate time (min.), and remaining time for timed operation (s) can be displayed.		
Maintenance monitor	DC link bus voltage, maximum effective current, input watt-hour, input watt-hour data, temperature (inverter internal temperature, maximum inverter internal temperature, heat sink temperature, maximum heat sink temperature), capacitance of the DC link bus capacitor, service life of DC link but capacitor (elapsed time/remaining time), cumulative run times (inverter power-ON time, electrolytic capacitors on printed circuit boards, cooling fans, individual motors), light-alarm contents (last four alarms), RS-485 error contents and number of error times, option error contents and number of error times, ROM version (inverter, keypad, and option)			
I/O check	Displays the I/O signal states of control circuit terminals using the segment ON/OFF of the 7-segment LED monitor or hexadecimal format. (digital and analog signals)			
Trip	Displays the cause of a trip by codes.			
Light-alarm	Shows the light-alarm display I-al.			
Running or trip mode	<ul style="list-style-type: none"> • Trip history: Saves and displays the cause of the last four trips (with a code). • Saves and displays the detailed running status data of the last four trips. 			

COMMON SPECIFICATIONS

Item	Explanation		Remarks											
Operating environment	Installation location	Indoors												
	Ambient	Standard (Open Type) -10 to +50°C (HHD/HND spec.) -10 to +40°C (HD/ND spec.) NEMA/UL Type 1 -10 to +40°C (HHD/HND spec.) -10 to +30°C (HD/ND spec.)												
	Ambient humidity	5 to 95%RH (without condensation)												
	Atmosphere	Shall be free from corrosive gases, flammable gases, oil mist, dusts, vapor, water drops and direct sunlight. (Pollution degree 2 (IEC60664-1)) The atmosphere must contain only a low level of salt. (0.01 mg/cm ² or less per year)												
	Altitude	1000m or lower If the inverter is used in an altitude above 1000 m, you should apply an output current derating factor as listed in below table. <table border="1" data-bbox="365 493 738 630"> <thead> <tr> <th>Altitude</th> <th>Output current derating factor</th> </tr> </thead> <tbody> <tr> <td>1000m or lower</td> <td>1.00</td> </tr> <tr> <td>1000 to 1500m</td> <td>0.97</td> </tr> <tr> <td>1500 to 2000m</td> <td>0.95</td> </tr> <tr> <td>2000 to 2500m</td> <td>0.91</td> </tr> <tr> <td>2500 to 3000m</td> <td>0.88</td> </tr> </tbody> </table>	Altitude	Output current derating factor	1000m or lower	1.00	1000 to 1500m	0.97	1500 to 2000m	0.95	2000 to 2500m	0.91	2500 to 3000m	0.88
Altitude	Output current derating factor													
1000m or lower	1.00													
1000 to 1500m	0.97													
1500 to 2000m	0.95													
2000 to 2500m	0.91													
2500 to 3000m	0.88													
Storage environment	Temperature	-25 to +70°C (in transport) -25 to +65°C (in storage) 5 to 95%RH	Avoid such places where the inverter will be subjected to sudden changes in temperature that will cause condensation to form.											
	Relative humidity	The inverter must not be exposed to dust, direct sunlight, corrosive or flammable gases, oil mist, vapor, water drops or vibration. The atmosphere must contain only a low level of salt. (0.01 mg/cm ² or less per year)												
	Atmospheric pressure	86 to 106kPa (during storage) 70 to 106kPa (during transportation)												

Note: The meaning of the described abbreviations are shown as follows.

VF: V/f control

IM-SVC(DTV): Speed sensorless vector control (Dynamic torque vector control)

VF with SC: V/f control with slip compensation

IMPG-VF: V/f control with speed sensor (The PG option card is required.)

IMPG-ATB: V/f control with speed sensor (+Auto Torque Boost)(The PG option card is required.)

IMPG-VC: Vector control with speed sensor (The PG option card is required.)

PM-SVC: Magnetic pole position sensorless vector control

TERMINAL CONNECTION DIAGRAM

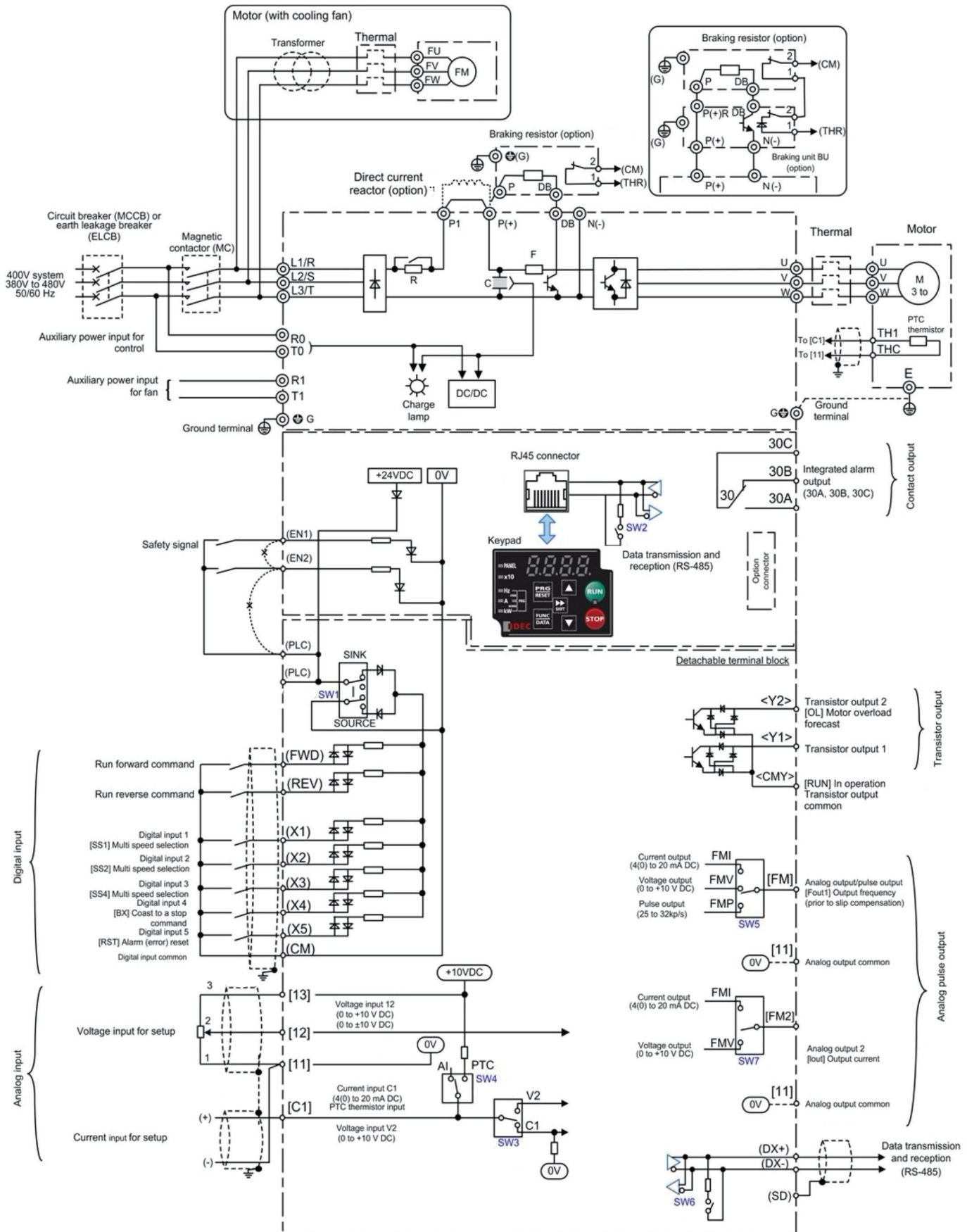

Note:
 *1 When connecting an optional DC reactor (DCR), remove the jumper bar from the terminals P1 and P(+). Use a DCR when the capacity of the power supply transformer exceeds 500 kVA and is 10 times or more the inverter rated capacity, or when there are thyristor-driven loads in the same power supply line.

TERMINAL FUNCTIONS

Classification	Terminal symbol	Terminal name	Specification	
Main circuit	L1/R, L2/S, L3/T	Main power input	Terminals to connect Three-phase power source.	
	L1/L, L2/N	Main power input	Terminals to connect Single-phase power source.	
	U, V, W	Inverter output	Terminals to connect Three-phase motors.	
	P (+), P1	For direct current reactor connection	Terminals to connect DC reactor (DCR) for power factor enhancement. It must be connected in the following cases: ND mode: Types VF1A-G139AS4.	
	P (+), N (-)	For direct current bus connection	Terminals to connect direct current intermediate circuit of other inverters and PWM converters.	
	P (+), DB	For braking resistor connection	Terminals to connect a braking resistor (optional). Wiring length: Below 5 meters. (Types VF1A-G72A0S4 or below)	
	G	For inverter chassis (case) grounding	Grounding terminal for inverter chassis (case).	
	R0, T0	Auxiliary power input for control circuit	When it is desired to retain the alarm signal for the activation of the protective function even inverter main power supply shut off or when continuous display of the keypad is desired, connect this terminal to the power supply. (Types VF1A-G59A0S4 or above)	
Analog input	[13]	Power supply for the potentiometer	The terminal is used for the power supply (DC+10 V 10 mA Max) for the external frequency command potentiometer (variable resistor: 1 to 5 k Ω). Connect variable resistors larger than 1/2 W.	
	[12]	Analog setup voltage input	(1) Frequency is set up according to the external analog voltage input command value. Normal operation <ul style="list-style-type: none"> DC0 to +10 V/0 to 100% (DC0 to +5 V/0 to 100%) DC0 to ± 10 V/0 to ± 100% (DC0 to ± 5 V/0 to ± 100%) Reverse operation <ul style="list-style-type: none"> DC+10 to 0V/0 to 100% (DC+5 to 0 V/0 to 100%) DC± 10 to 0V/0 to ± 100% (DC± 5 to 0V/0 to ± 100%) (2) The terminal can be assigned to PID command, feedback signal of PID control, auxiliary frequency setup, ratio setup, torque limit setup, and analog input monitor aside from the frequency setup by analog input. (3) Hardware specification * Input impedance: 22 (k Ω), * Up to DC ± 15 V can be input. However, input exceeding DC ± 10 V will be recognized as DC ± 10 V.	
		Analog setup current input (C1 function)	(1) Frequency is set up according to the external analog current input command value. Normal operation <ul style="list-style-type: none"> DC4 to 20 mA/0 to 100%/-100% to 0 to 100% DC0 to 20 mA/0 to 100%/-100% to 0 to 100% Reverse operation <ul style="list-style-type: none"> DC20 to 4 mA/0 to 100%/-100% to 0 to 100% DC20 to 0 mA/0 to 100%/-100% to 0 to 100% (2) The terminal can be assigned to PID command, feedback signal of PID control, auxiliary frequency setup, ratio setup, torque limit setup, and analog input monitor aside from the frequency setup by analog input. (3) Hardware specification * Input impedance: 250 (Ω), Up to DC 30 mA can be input. However, input exceeding DC 20 mA will be recognized as DC 20 mA.	
	[C1]	Analog setup voltage input (V2 function)	(1) Frequency is set up according to the external analog voltage input command value. SW3 must be switched on the printed circuit board. Normal operation <ul style="list-style-type: none"> DC0 to +10 V/0 to 100% (DC0 to +5 V/0 to 100%) DC0 to +10 V/-100 to 0 to 100% (DC0 to +5 V/-100 to 0 to 100%) Reverse operation <ul style="list-style-type: none"> DC+10 to 0 V/0 to 100% (DC+5 V to 0 V/0 to 100%) DC+10 to 0 V/-100 to 0 to 100% (DC+5 to 0 V/-100 to 0 to 100%) (2) The terminal can be assigned to PID command, feedback signal of PID control, auxiliary frequency setup, ratio setup, torque limit setup, and analog input monitor aside from the frequency setup by analog input. (3) Hardware specification * Input impedance: 22(k Ω), Up to DC+15 V can be input. However, input exceeding DC+10 V will be recognized as DC+10 V.	
		PTC thermistor input (PTC function)	PTC (Positive Temperature Coefficient) thermistor for motor protection can be connected. SW3 (C1/V2 Switch) and SW4 (PTC /AI Switch) must be switched on the printed circuit board.	
Analog input	[11]	Analog input common	The terminal is the common terminal for analog input signals (terminals [12], [13], [C1]). The terminal is insulated from terminals [CM], [CMY].	
Digital input	[X1]	Digital input 1	(1) Various signals (coast to a stop command, external alarm, multi-speed selection, etc.) set up by function codes E01 to E05, E98, E99 can be set up. (2) Input mode, sink/source can be switched using SW1. (3) The operating mode of the various digital input terminals when connected with terminal CM (sink mode) / PLC (source mode) can be switched to "ON when shorted with CM/PLC (active ON)" or "OFF when shorted with CM/PLC (active OFF)" (4) Digital input terminal [X5] can be set up as a pulse train input terminal by changing the function code	
	[X2]	Digital input 2		
	[X3]	Digital input 3		
	[X4]	Digital input 4		
	[X5]	Digital input 5/pulse train input	Maximum wiring length 20 meters	
	[FWD]	Run forward command	Maximum input pulse	
	[REV]	Run reverse command	30 kHz: When connected to open collector output pulse generator 100 kHz: When connected to complementary output pulse generator	
		[EN1] [EN2]	Enable input	(1) When terminals [EN1]-[PLC] or terminals [EN2]-[PLC] are OFF, the inverter output transistors stop switching (safe torque off: STO). Be sure to operate terminals [EN1] and [EN2] simultaneously; otherwise an ecf alarm is issued and the operation of the inverter will be disabled. To enable the Enable function, remove the short bar. (2) The input mode for terminals [EN1] and [EN2] is fixed to source. The mode cannot be switched to sink. (3) Short terminals [EN1]-[PLC] and [EN2] - [PLC] using shorting bars when the enable input function is not used (Keep the shorting bar connected).
		[PLC]	Programmable controller signal power source	(1) The terminal is used for connecting the output signal power source of the programmable controller (rated voltage DC +24 V (power supply voltage fluctuation range: DC +22 to +27 V) maximum 100 mA). (2) The terminal can also be used for the power source for the load connected to the transistor outputs. For details, refer to the page on "Transistor outputs".
	[CM]	Digital common	This terminal is the common terminal for digital input signals. This terminal is insulated from terminals [11] and [CMY].	

TERMINAL FUNCTIONS

Classification	Terminal symbol	Terminal name	Specification
Analog output / pulse output	[FM]	Analog monitor FMV function FMI function	This terminal outputs analog direct current voltage DC0 to 10 V or analog direct current DC4 to 20 mA / DC0 to 20mA monitor signal. The output form (FMV/FMI) can be switched using SW5 on the printed circuit board and function code F29. The signal content can be chosen in the function code F31 data setting among the following items. <ul style="list-style-type: none"> • Output frequency 1 (before slip compensation) • Output frequency 2 (after slip compensation) • Output current • Output voltage • Output torque • Load factor • Input power • PID feedback value • Actual speed/estimated speed • DC link bus voltage • Universal AO • Motor output • Calibration (+) • PID command (SV) • PID output (MV) • Position error in master-follower operation • Inverter heat sink temperature • PG feedback value • Customizable logic output signal 1 to 10 * Allowable impedance for connection: Min 5 kW (at DC to 10 V output) (up to 2 analog volt meters (DC0 to 10 V, input impedance 10 kW) can be connected.) * Allowable impedance for connection: Max 500 W (at DC4 to 20 mA/DC0 to 20 mA) * Gain adjustable range: 0 to 300%
		Pulse monitor FMP function	The terminal outputs pulse signal. Signal content can be chosen same as for the FMV function by function code F31 setting. The output form (FMP) can be switched using SW5 on the printed circuit board and function code F29. * Allowable impedance for connection: Min. 5 kW (at DC to 10 V output) (up to 2 analog volt meters (DC0 to 10 V, input impedance 10 kW) can be connected.) *Pulse duty: Approximately 50%, pulse rate: 25 to 32000 p/s (at full scale)
	[11]	Analog output common terminal	This terminal is the common terminal for analog input and analog/pulse output signals. The terminal is insulated from terminals [CM] and [CMY].
Transistor outputs	[Y1]	Transistor output 1	(1) Various signals (running signal, frequency reached signal, overload forecast signal, etc) set up by function code E20, E21 can be output. (2) The operating mode of the transistor output terminals [Y1], [Y2] can be switched to "ON (active ON) at signal output" or "OFF (active OFF) at signal output".
	[Y2]	Transistor output 2	
	[CMY]	Transistor output common	This terminal is the common terminal for transistor output signals. This terminal is insulated from terminals [CM] and [11].
Contact output	[30A/B/C]	Integrated alarm output	(1) When the inverter stops with an alarm, output is generated on the relay contact (1C). Contact rating: AC250 V 0.3 A cosφ = 0.3, DC48 V 0.5 A (2) Terminals can be switched to "Terminals [30A to 30C] shorted (excitation: active ON) at ON signal output" or "Terminals [30A to 30C] open (non-excitation: active OFF) at ON signal output"
Communication	RJ-45 connector for keypad connection	RJ-45 connector for keypad connection RS-485 communication port 1	(1) Used to connect the keypad. The power to the keypad will be supplied from the inverter through this connector. (2) Also can be used to connect a computer, programmable controller, etc by RS-485 communication, after removing the keypad. <ul style="list-style-type: none"> • Pins 1, 2, 7, and 8 are assigned as power supply source for the keypad. When connecting this RJ-45 connector to other devices, do not use these pins.
	RJ-45 connector for RS-485	RS-485 communication port 2	Can be used to connect a computer, programmable controller, etc by RS-485 communication.

DIMENSIONS

Part Number	Frame Size	Dimensions [mm (inch)]						
		W	W1	H	H1	D	D1	D2
VF1A-G02A1S4	B1	110 (4.33)	96.3 (3.79)	130 (5.12)	118 (4.65)	119 (4.69)	85 (3.35)	34 (1.34)
VF1A-G04A1S4						143 (5.63)		
VF1A-G05A5S4								
VF1A-G06A9S4								
VF1A-G12A0S4	B2	130 (5.12)	118 (4.85)	130 (5.12)	118 (4.65)	143 (5.63)	85 (3.35)	58 (2.28)
VF1A-G21A5S4	B3	180 (7.09)	164 (6.46)	220 (8.66)	205 (8.07)	158 (6.22)	-	-
VF1A-G28A5S4								
VF1A-G37A0S4	B4	220 (8.66)	196 (7.72)	260 (10.24)	238 (9.37)	190 (7.48)	-	-
VF1A-G44A0S4								
VF1A-G59A0S4	B5	250 (9.84)	226 (8.9)	400 (15.75)	378 (14.88)	195 (7.68)	-	-
VF1A-G72A0S4								
VF1A-G85A0S4	B6	326.2 (12.9)	240 (9.45)	550 (21.65)	530 (20.87)	261 (10.28)	-	-
VF1A-G105AS4								
VF1A-G139AS4	B7	361.2 (14.3)	275 (10.83)	615 (24.21)	595 (23.43)	310.2 (12.3)	-	-

B1

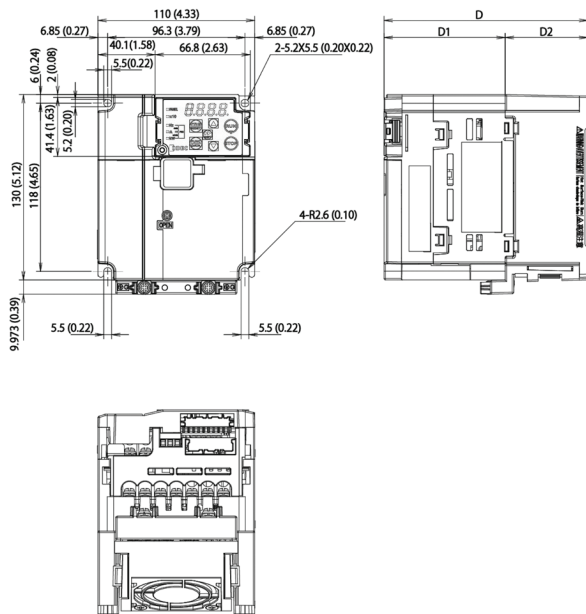

B2

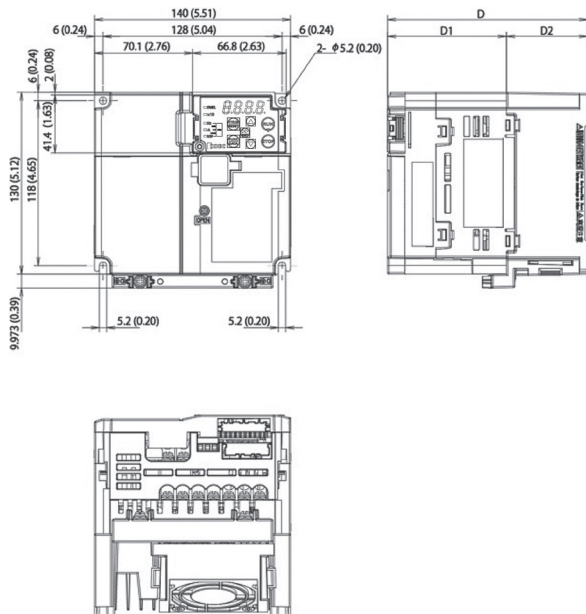

B3

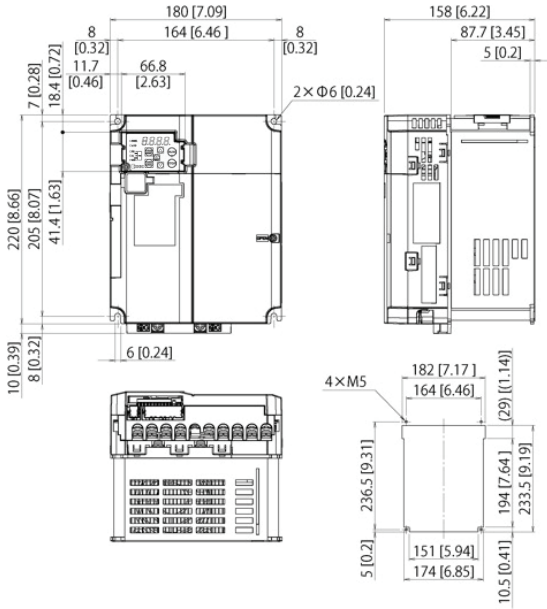

B4

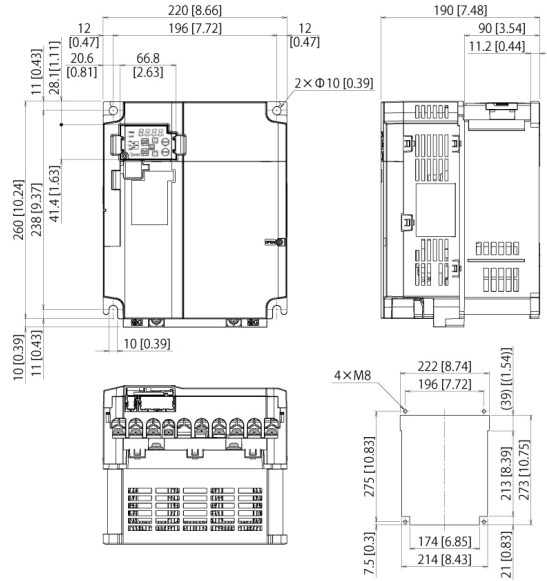

B5

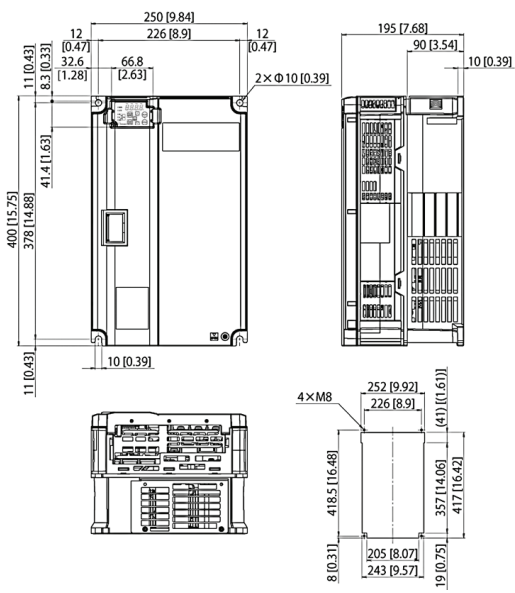

B6

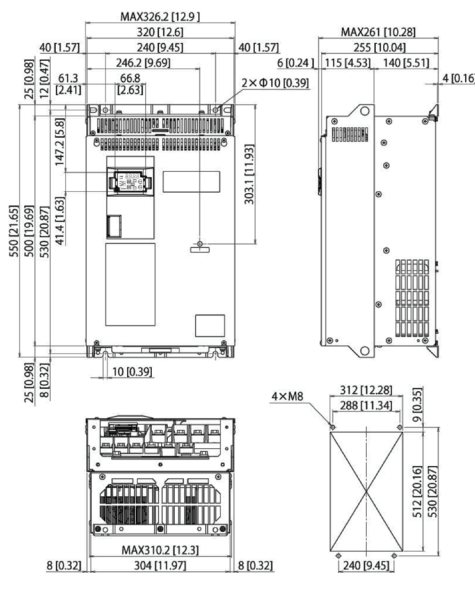

B7

