

FT9Y-B1378(5)

FT1A SERIES

Smart **AXIS**

Pro/Lite User's Manual

IDEC CORPORATION

SAFETY PRECAUTIONS

- Read the SmartAXIS Pro/Lite User's Manual to ensure correct operation before starting installation, wiring, operation, maintenance, and inspection of the SmartAXIS.
- All SmartAXIS modules are manufactured under IDEC's rigorous quality control system, but users must add a backup or failsafe provision to the control system when using the SmartAXIS in applications where heavy damage or personal injury may be caused, in case the SmartAXIS should fail.
- In this user's manual, safety precautions are categorized in order of importance:



Warning Warning notices are used to emphasize that improper operation may cause severe personal injury or death.

- The SmartAXIS is not designed for use in medical equipment, nuclear power, railways, aviation, passenger vehicle equipment, or similar applications requiring a high degree of reliability and safety. The SmartAXIS should not be used for such applications.
- When using the SmartAXIS in applications (not described above) that require a high degree of reliability in terms of functionality and precision, appropriate measures such as failsafe mechanisms and redundant mechanisms must be taken for the system containing the SmartAXIS.
 - Emergency stop and interlocking circuits must be configured outside the SmartAXIS.
 - If relays or transistors in the SmartAXIS output circuits should fail, outputs may remain at on or off state. For output signals which may cause serious accidents, configure monitor circuits outside the SmartAXIS.
 - The SmartAXIS self-diagnostic function may detect internal circuit or program errors, stop programs, and turn outputs off. Configure circuits so that the system containing the SmartAXIS is not jeopardized when outputs turn off.
- Turn off power to the SmartAXIS before installation, removal, wiring, maintenance, and inspection of the SmartAXIS. Failure to turn power off may cause electrical shocks or fire hazard.
- Special expertise is required to install, wire, program, and operate the SmartAXIS. People without such expertise must not use the SmartAXIS.
- Install the SmartAXIS according to the instructions described in SmartAXIS Pro/Lite user's manual. Improper installation will result in falling, failure, or malfunction of the SmartAXIS.



Caution Caution notices are used where inattention might cause personal injury or damage to equipment.

- The SmartAXIS is designed for installation in a cabinet. Do not install the SmartAXIS outside a cabinet.
- Install the SmartAXIS in environments described in the SmartAXIS Pro/Lite user's manual. If the SmartAXIS is used in places where the SmartAXIS is subjected to high-temperature, high-humidity, condensation, corrosive gases, excessive vibrations, or excessive shocks, then electrical shocks, fire hazard, or malfunction will result.
- The environment for using the SmartAXIS is "Pollution degree 2." Use the SmartAXIS in environments of pollution degree 2 (according to IEC 60664-1).
- Prevent the SmartAXIS from falling while moving or transporting the SmartAXIS, otherwise damage or malfunction of the SmartAXIS will result.
- Wiring must use lead sizes that are appropriate for the applied voltage and current. Terminal screws must be tightened with the prescribed tightening torque.
- Prevent metal fragments and pieces of wire from dropping inside the SmartAXIS housing. Put a cover on the SmartAXIS modules during installation and wiring. Ingress of such fragments and chips may cause fire hazard, damage, or malfunction.
- Use a power supply of the rated value. Use of a wrong power supply may cause fire hazard.
- Use an IEC 60127-approved fuse on the power line outside the SmartAXIS. This is required when equipment containing the SmartAXIS is destined for Europe.
- Use an IEC 60127-approved fuse on the output circuit. This is required when equipment containing the SmartAXIS is destined for Europe.
- Use an EU-approved circuit breaker. This is required when equipment containing the SmartAXIS is destined for Europe.
- Make sure of safety before starting and stopping the SmartAXIS or when operating the SmartAXIS to force outputs on or off. Incorrect operation of the SmartAXIS may cause machine damage or accidents.
- Do not connect the ground wire directly to the SmartAXIS. Connect a protective ground to the cabinet containing the SmartAXIS using an M4 or larger screw. This is required when equipment containing the SmartAXIS is destined for Europe.
- Do not disassemble, repair, or modify the SmartAXIS modules.
- The SmartAXIS contains electronic parts and batteries. When disposing of the SmartAXIS, do so in accordance with national and local regulations.



ABOUT THIS MANUAL

This user's manual describes functions, specifications, installation, and operation basics of the SmartAXIS. Also included is information on the powerful communications tools of the SmartAXIS, as well as troubleshooting procedures.

Chapter 1: General Information

General information about the SmartAXIS, features, brief description on special functions, and various system setup configurations for communication.

Chapter 2: Product Specifications

Specifications of SmartAXIS, optional adapters, and cartridges.

Chapter 3: Installation and Wiring

Methods and precautions for installing and wiring the SmartAXIS.

Chapter 4: Operation Basics

General information about setting up the basic SmartAXIS system for programming, starting and stopping SmartAXIS operation, and simple operating procedures. Everything from creating a user program using WindLDR on a computer to monitoring the SmartAXIS operation.

Chapter 5: Special Functions

Stop/reset inputs, run/stop selection at memory backup error, and keep designation. Also included are high-speed counter, frequency measurement, catch input, interrupt input, timer interrupt, input filter, user program protection, daylight savings time, network settings, and many more special functions.

Chapter 6: HMI Function

HMI function on the SmartAXIS Pro by using the LCD and operation buttons on the SmartAXIS.

Chapter 7: Device Addresses

Device addresses available for the SmartAXIS to program basic and advanced instructions. Special internal relays and special data registers are also described.

Chapter 8: Instructions Reference

List of basic and advanced instructions to program the SmartAXIS.

Chapter 9 through Chapter 11: Maintenance Communication, User Communication Instructions, Modbus Communication

Various communication functions such as user communication and Modbus communication.

Chapter 12: Remote I/O

Remote I/O communication to increase the number of inputs and outputs by connecting other SmartAXIS as remote I/O slaves over Ethernet.

Chapter 13: Script

Programming complicated processing with script language using conditional branching, logical operations, arithmetic operations, and functions.

Chapter 14: Troubleshooting

Procedures to determine the cause of trouble and actions to be taken when any trouble occurs while operating the SmartAXIS.

Appendix

Additional information about type numbers, system software upgrade, and USB driver installation.

Index

Alphabetical listing of key words.

Publication history

March 2013	First Edition
August 2013	Second Edition
October 2013	Third Edition
December 2013	Fourth Edition
August 2014	Fifth Edition
May 2019	Sixth Edition

Trademarks

SmartAXIS is a trademark of IDEC Corporation.

Regarding laws and compatible standards

This product adheres to the laws and compatible standards of all countries involved, as shown below.

European laws and standards

This product complies with the following EU directives.

- Low Voltage Directive (Directive 2006/95/EC)
- EMC Directive (Directive 2004/108/EC)

To comply with these directives, this product has been designed and evaluated on the basis of the following international and European standard.

- IEC/EN 61131-2: 2007 (excluding the Lite digital I/O status indicators)

For details on the compatible standards and EU Directives, contact the distributor from which you purchased this product or visit our web site.

North America laws and standards

This product complies with the following standards.

- UL508
- CSA C22.2 No.14

Marine standards

This product is certified by the following classification societies. (FT1A Version V130 or later, system software version V2.10 or later)

- ABS (American Bureau of Shipping)
- DNV (Det Norske Veritas, Norwegian classification society)
- LR (Lloyd's Register)
- NK (Nippon Kaiji Kyokai)

- To use this product as a marine certified product, wrap the power supply cable (excluding the earth wire) and the Ethernet communication cable connected to the SmartAXIS around a ferrite core (TDK ZCAT3035-1330) twice.
- Wrap cables connected to the communication cartridge around a ferrite core (TDK ZCAT1730-0730) twice.
- This product is not certified for use on the bridge and deck.

IMPORTANT INFORMATION

Under no circumstances shall IDEC Corporation be held liable or responsible for indirect or consequential damages resulting from the use of or the application of IDEC PLC components, individually or in combination with other equipment.

All persons using these components must be willing to accept responsibility for choosing the correct component to suit their application and for choosing an application appropriate for the component, individually or in combination with other equipment.

All diagrams and examples in this manual are for illustrative purposes only. In no way does including these diagrams and examples in this manual constitute a guarantee as to their suitability for any specific application. To test and approve all programs, prior to installation, is the responsibility of the end user.

RELATED MANUALS

The following manuals related to the SmartAXIS are available. Refer to them in conjunction with this manual.

Type No.	Manual Name	Description
FT9Y-B1378	SmartAXIS Pro/Lite User's Manual (this manual)	Describes product specifications, installation and wiring instructions, instructions for basic programming operations and special functions, device and instruction lists, communication functions, and troubleshooting procedures for the SmartAXIS Pro/Lite series.
FT9Y-B1382	SmartAXIS Ladder Programming Manual	Describes basic operations for ladder programming, instructions for monitoring ladders on the SmartAXIS, available devices and instruction lists, and details of each instruction.
FT9Y-B1386	SmartAXIS FBD Programming Manual	Describes basic operations for function block programming, available devices and function block lists, and details of each function block.
FT9Y-B1390	SmartAXIS Touch User's Manual	Describes product specifications, installation and wiring instructions, instructions for setting basic programming actions and special functions, device and instruction lists, communication functions, and troubleshooting procedures for the Touch series.
WindLDR Help		Describes usage instructions for WindLDR, programming software for the SmartAXIS Pro/Lite series.
WindO/I-NV3 Help		Describes programming for the SmartAXIS Touch series, and usage instructions for the WindO/I-NV3 configuration software.

NAMES AND ABBREVIATIONS USED IN THIS MANUAL

Model Names

Name Used in this Manual	Description (Detailed Type No.)
SmartAXIS	Name for the FT1A programmable logic controllers.
SmartAXIS Lite	Modules without LCD. (FT1A-B12RA, FT1A-B12RC, FT1A-B24RA, FT1A-B24RC, FT1A-B40RKA, FT1A-B40RSA, FT1A-B40RC, FT1A-B48KA, FT1A-B48SA, FT1A-B48KC, FT1A-B48SC)
SmartAXIS Pro	Modules with LCD. (FT1A-H12RA, FT1A-H12RC, FT1A-H24RA, FT1A-H24RC, FT1A-H40RKA, FT1A-H40RSA, FT1A-H40RC, FT1A-H48KA, FT1A-H48SA, FT1A-H48KC, FT1A-H48SC)
SmartAXIS Touch	Modules that extend the functionality of display. (FT1A-M12RA-W, FT1A-M12RA-B, FT1A-M12RA-S, FT1A-C12RA-W, FT1A-C12RA-B, FT1A-C12RA-S, FT1A-M14KA-W, FT1A-M14KA-B, FT1A-M14KA-S, FT1A-M14SA-W, FT1A-M14SA-B, FT1A-M14SA-S, FT1A-C14KA-W, FT1A-C14KA-B, FT1A-C14KA-S, FT1A-C14SA-W, FT1A-C14SA-B, FT1A-C14SA-S)
12-I/O type	SmartAXIS Pro and Lite models with 12 I/O points. (FT1A-B12RA, FT1A-B12RC, FT1A-H12RA, FT1A-H12RC)
24-I/O type	SmartAXIS Pro and Lite models with 24 I/O points. (FT1A-B24RA, FT1A-B24RC, FT1A-H24RA, FT1A-H24RC)
40-I/O type	SmartAXIS Pro and Lite models with 40 I/O points. (FT1A-B40RKA, FT1A-B40RSA, FT1A-B40RC, FT1A-H40RKA, FT1A-H40RSA, FT1A-H40RC)
48-I/O type	SmartAXIS Pro and Lite models with 48 I/O points. (FT1A-B48KA, FT1A-B48SA, FT1A-B48KC, FT1A-B48SC, FT1A-H48KA, FT1A-H48SA, FT1A-H48KC, FT1A-H48SC)
AC power type	SmartAXIS Pro and Lite models with an AC power supply. (FT1A-B12RC, FT1A-H12RC, FT1A-B24RC, FT1A-H24RC, FT1A-B40RC, FT1A-H40RC, FT1A-B48KC, FT1A-B48SC, FT1A-H48KC, FT1A-H48SC)
DC power type	SmartAXIS Pro and Lite models with a DC power supply. (FT1A-B12RA, FT1A-H12RA, FT1A-B24RA, FT1A-H24RA, FT1A-B40RKA, FT1A-H40RKA, FT1A-B40RSA, FT1A-H40RSA, FT1A-B48KA, FT1A-B48SA, FT1A-H48KA, FT1A-H48SA)

Abbreviations

Abbreviation	Meaning
FBD	Function block diagram
FB	Function block For example, the AND (logical AND) function block is written as AND FB.

TABLE OF CONTENTS

	Safety Precautions	Preface-1
	About This Manual	Preface-2
	Related Manuals	Preface-4
	Names and Abbreviations Used in this Manual.....	Preface-5
CHAPTER 1:	General Information	
	About the SmartAXIS	1-1
	Features.....	1-3
	Special Functions	1-4
	Communication Functions.....	1-6
	Maintenance Communication	1-7
	User Communication	1-8
	Modbus Communication	1-8
	Remote I/O	1-9
	Ethernet Communication	1-9
	Operator Interface Connectivity	1-10
CHAPTER 2:	Product Specifications	
	Parts Description.....	2-1
	Communication Cartridge	2-23
	Memory Cartridge	2-25
	Ethernet Port	2-27
	SD Memory Card.....	2-28
	Dimensions.....	2-30
CHAPTER 3:	Installation and Wiring	
	Installation Location	3-1
	Mounting Space	3-2
	Mounting on DIN Rail	3-3
	Removing from DIN Rail.....	3-3
	Direct Mounting on Panel Surface.....	3-4
	Input/Output Wiring.....	3-7
	Power Supply	3-11
	Terminal Connection	3-13
	Securing the Panel Attachment USB Extension Cable	3-14
CHAPTER 4:	Operation Basics	
	Start WindLDR.....	4-1
	PLC Selection.....	4-2
	Create Program	4-3
	Convert Program.....	4-11
	Save Project	4-11
	Simulate Operation	4-12
	Download Program	4-14
	Monitor Operation.....	4-15
	Exit WindLDR	4-16
	Start/Stop Operation	4-17
CHAPTER 5:	Special Functions	
	Function Area Settings	5-2
	Stop Input and Reset Input	5-4
	Run/Stop Selection at Memory Backup Error	5-5
	Run/Stop Selection at Power Up.....	5-6
	Keep Designation for Internal Relays, Shift Registers, Counters, and Data Registers	5-7
	Data Register ROM Backup	5-9
	High-Speed Counter.....	5-13
	Catch Input	5-32
	Interrupt Input	5-34
	Frequency Measurement	5-36
	Input Filter	5-38

Analog Input	5-39
Timer Interrupt	5-41
Forced I/O function	5-43
Communication Ports	5-46
Memory Cartridge	5-49
SD Memory Card	5-52
Backlight ON Time	5-57
Monitoring Ladder Program	5-58
Message Settings	5-60
32-bit Data Storage Setting	5-62
User Program Protection	5-64
Watchdog Timer Setting	5-66
Constant Scan Time	5-67
Daylight Savings Time	5-68
Clock Function	5-69
Network Settings	5-72
Connection Settings	5-73
Remote Host List	5-75

CHAPTER 6:

HMI Function

About the Menu Screen	6-2
Basic Operations	6-3
Switching to the System Menu	6-6
Switching run/stop	6-7
SmartAXIS Environment Settings	6-8
Monitoring the SmartAXIS	6-15
Checking/Clearing Error Information	6-20
Uploading/Downloading the User Program	6-22
Displaying Arbitrary Messages	6-24
Maintaining the SD Memory Card	6-25
Entering a Password	6-27
System Menu Hierarchy Diagram	6-28

CHAPTER 7:

Device Addresses

Device Addresses	7-1
Special Internal Relays	7-2
Special Data Registers	7-8

CHAPTER 8:

Instructions/Function Blocks Reference

Ladder Program Instructions List	8-1
Advanced Instruction List	8-3
Advanced Instruction Applicable SmartAXIS	8-6
FB List	8-9

CHAPTER 9:

Maintenance Communication

Maintenance Communication via USB Port	9-2
Maintenance Communication via Expansion Communication Port	9-3
Maintenance Communication via Ethernet Port	9-5

CHAPTER 10:

User Communication Instructions

User Communication via Serial Communication	10-1
User Communication Overview	10-1
User Communication Mode Specifications	10-1
RS232C User Communication System Setup	10-2
RS485 User Communication System Setup	10-3
Programming WindLDR	10-4
RS232C Line Control Signals	10-11
User Communication via Ethernet Communication	10-14
Ethernet User Communication Overview	10-14
User Communication Client	10-16

TABLE OF CONTENTS

	User Communication Server	10-19
	Programming WindLDR (User Communication Server)	10-20
	User Communication Error	10-22
	ASCII Character Code Table	10-23
	Sample Program – User Communication TXD	10-24
	Sample Program – User Communication RXD	10-26
CHAPTER 11:	Modbus Communication	
	Modbus Communication via RS-232C/RS-485	11-1
	Modbus Master Communication	11-2
	Modbus Slave Communication	11-8
	Communication Format	11-12
	Modbus Communication via Ethernet Communication	11-18
	Modbus TCP Client	11-19
	Modbus TCP Server	11-24
CHAPTER 12:	Remote I/O	
	Remote I/O Master	12-2
	Remote I/O Slave	12-8
CHAPTER 13:	Scripts	
	Script Programming and Management	13-3
	Programming Scripts	13-10
	Script Programming Examples	13-16
	Important Notes	13-35
	About the Priority of the Operator	13-35
CHAPTER 14:	Troubleshooting	
	Reading Error Data	14-1
	Special Data Registers for Error Information	14-3
	General Error Codes	14-3
	SmartAXIS Operating Status, Output, and ERR LED during Errors	14-4
	Error Causes and Actions	14-4
	User Program Execution Error	14-6
	Troubleshooting Diagrams	14-7
APPENDIX		
	System Software	A-1
	USB Driver Installation Procedure	A-5
	Cables	A-8
	HMI Screen Transition Diagram	A-11
	Type List	A-15
	Fonts	A-17
INDEX		

1: GENERAL INFORMATION

Introduction

This chapter describes SmartAXIS functions and system configuration examples. The SmartAXIS is available in three types: the SmartAXIS Lite, the SmartAXIS Pro, and the SmartAXIS Touch. The SmartAXIS Lite is equipped with the same various control and communication functions as a PLC. In addition to the functions of the SmartAXIS Lite, the SmartAXIS Pro is equipped with an LCD and operation buttons on the front of the module. The SmartAXIS Touch is equipped with the HMI functions of an operator interface and PLC control functions.

This document describes the SmartAXIS Lite and Pro. Unless otherwise specified, SmartAXIS refers to the SmartAXIS Lite and Pro. For the SmartAXIS Touch, refer to the SmartAXIS Touch User's Manual.

About the SmartAXIS

The SmartAXIS is a small-size programmable controller that is fully equipped with powerful functions and various communication functions.

You can select the type of SmartAXIS best-suited for your applications, in such ways as the inclusion of the display function, the type of power supply, and the number of inputs and outputs.

The SmartAXIS Lite is equipped with basic functions. The SmartAXIS Pro adds to the functionality of the SmartAXIS Lite and is equipped with an LCD and operation buttons on the module, enabling independent monitor and operation functions.

The SmartAXIS supports 100 to 240V AC and 24V DC power supplies. SmartAXIS with Ethernet port (24-, 40-, 48-I/O types) can expand the number of inputs and outputs for a maximum of 90 inputs and a maximum of 54 outputs using the remote I/O function.

User programs can be created using WindLDR, the PLC programming software.

The SmartAXIS supports ladder programs and function block programs. Ladder programs for FT1A are compatible with other IEC PLCs including MicroSmart and MicroSmart Pentra, so you can make use of existing software assets.

Type Numbers

The notation for SmartAXIS part numbers is as follows.

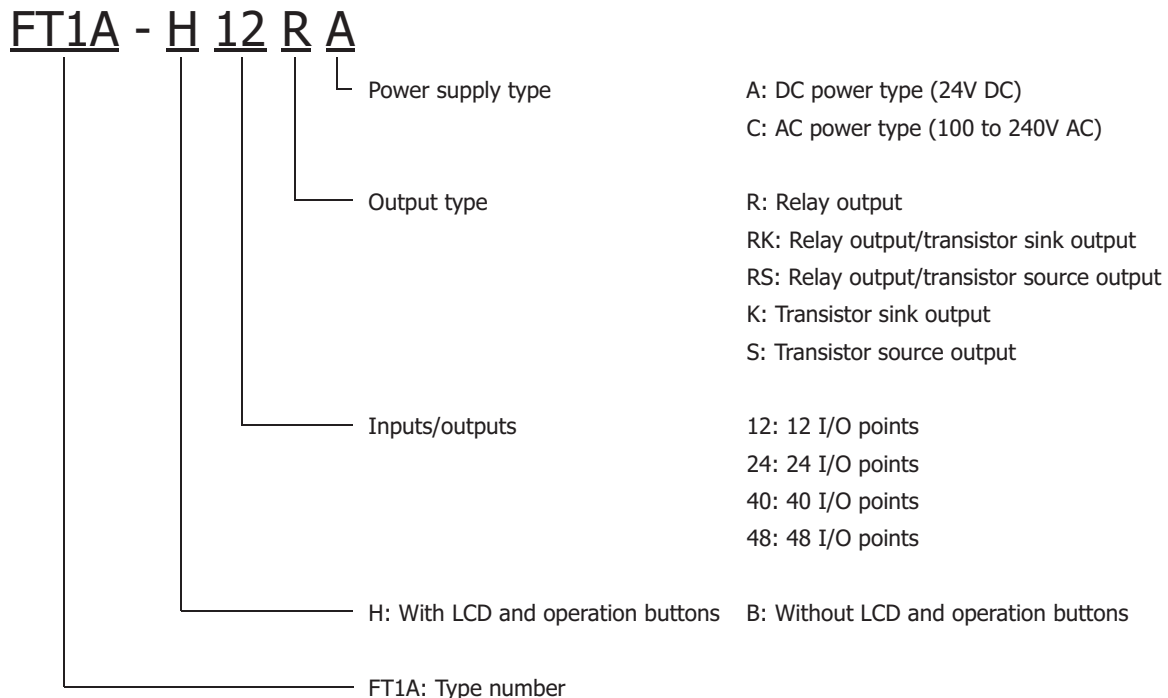

Note: For the input specifications, see "Input Specifications (AC Power Type)" on page 2-8 to "Input Specifications (DC Power Type)" on page 2-10.

1: GENERAL INFORMATION

Type List

Type Number	Power Supply	Inputs and Outputs (In/Out)	LCD, Operation Buttons	USB Port	Expansion Communication Port	Ethernet Port	SD Memory Card slot				
FT1A-H12RA	24V DC	12 (8/4)	Yes	Yes	—	—	—				
FT1A-H12RC	100 to 240V AC		—								
FT1A-B12RA	24V DC	24 (16/8)	Yes								
FT1A-B12RC	100 to 240V AC		—								
FT1A-H24RA	24V DC	40 (24/16)	Yes		Yes 1 port	Yes		Yes			
FT1A-H24RC	100 to 240V AC		—								
FT1A-B24RA	24V DC		48 (30/18)						Yes	Yes 2 ports	Yes
FT1A-B24RC	100 to 240V AC	—									
FT1A-H40RKA	24V DC	40 (24/16)					Yes				
FT1A-H40RSA	100 to 240V AC		—								
FT1A-B40RKA	24V DC	48 (30/18)	Yes		Yes 2 ports	Yes	Yes				
FT1A-B40RSA	100 to 240V AC		—								
FT1A-H48KA	24V DC		48 (30/18)						Yes		
FT1A-H48SA	100 to 240V AC	—									
FT1A-B48KA	24V DC	48 (30/18)	Yes						Yes 2 ports	Yes	Yes
FT1A-B48SA	100 to 240V AC		—								
FT1A-B48KC	24V DC		48 (30/18)	Yes							
FT1A-B48SC	100 to 240V AC	—									

Options

RS232C Communication Cartridge
FT1A-PC1 (Mini-DIN type)

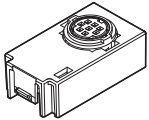

Memory Cartridge
FT1A-PM1



USB Maintenance Cable
HG9Z-XCM42

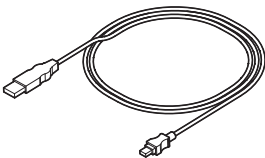

RS485 Communication Cartridge
FT1A-PC2 (Mini-DIN type)

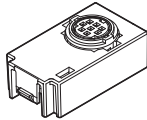

SD Memory Card (2GB)
HG9Z-XMS2

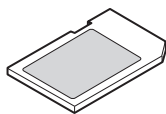

Panel Mount USB Extension Cable
HG9Z-XCE21

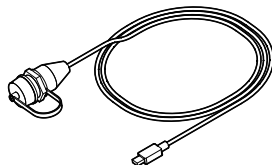

RS485 Communication Cartridge
FT1A-PC3 (Terminal block type)

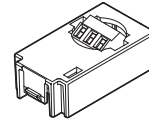

Features

This section describes the features of the SmartAXIS.

The SmartAXIS is high-performance programmable controller in a compact package and is equipped with high speed counters that can be used for positioning control. The SmartAXIS enables you to build optimum systems to automate factories or control production lines.

Powerful HMI Functions

The SmartAXIS Pro is equipped with an LCD on the front of the module, enabling you to monitor the device values and the ladder program. Customized messages can be programmed to display current time, bar charts, scrolling messages, or simple text on the LCD. The operation buttons on the module are used for operations with LCD such as checking and modifying device values.

Powerful Communication Functions

The SmartAXIS supports various communications such as maintenance communication, user communication, Modbus communication, and remote I/O.

The SmartAXIS is equipped with RS232C (optional), RS485 (optional), an Ethernet port, and a USB port, and can be connected to various devices such as computers, operator interfaces, and printers.

RS232C Communication Cartridge
FT1A-PC1 (Mini-DIN type)

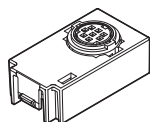

RS485 Communication Cartridge
FT1A-PC2 (Mini-DIN type)

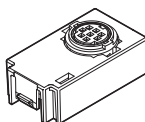

RS485 Communication Cartridge
FT1A-PC3 (Terminal block type)

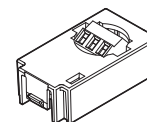

Memory Cartridge

A user program of SmartAXIS can be stored in a memory cartridge (FT1A-PM1). When a memory cartridge is inserted into a SmartAXIS, the user program in the memory cartridge is executed instead of the user program in the SmartAXIS. You can also download the user program in a memory cartridge to the SmartAXIS.

Memory Cartridge
FT1A-PM1



SD Memory Card

The 40- and 48-I/O types are equipped with an SD memory card slot. The log data of device values can be saved to an optional SD memory card (HG9Z-XMS2) or a commercially available SD memory card (32 GB maximum).

32-bit and Floating Point Data Types

Some advanced instructions can select 32-bit data types from D (double word), L (long), and F (float) in addition to W (word) and I (integer).

Safety and High-Quality Compliant with International Standards

The SmartAXIS is compliant with international standards and can be used all over the world while maintaining safety and high quality.

Supports 9 Languages

The SmartAXIS LCD supports the display of the following nine languages:

Setting Name	Character Set	Supported Languages
European	ISO 8859-1 (Latin-1)	English, German, Italian, Spanish, Dutch (Note), French (Note)
Japanese	Shift-JIS	Japanese (level 1)
Chinese	GB2312	Chinese (simplified)
Cyrillic	ANSI 1251	Russian

Note: Some of the characters cannot be input.

Special Functions

This section describes the functions of the SmartAXIS.

I/O Related Functions

Catch Input

The catch input receives short input pulses from sensors without regard to the scan time. A maximum of 6 catch inputs can be used.

Input Filter

The input filter can be adjusted, according to the width of input signals, to reject input noises. Selectable input filter values to pass input signals are 0ms, and 3 through 15ms in 1ms increments. The input filter rejects inputs shorter than the selected input filter value minus 2ms. This function is useful for eliminating input noises and chatter in limit switches.

Interrupt Input

The interrupt input can be used to call an interrupt program to respond to an external input that requires a response faster than the scan time. A maximum of six interrupt inputs can be used. This can only be used when ladder program is selected as the programming language.

Stop and Reset Inputs

Stop input is a function to stop SmartAXIS operation. Reset input is a function to stop SmartAXIS operation and clear device values. Any input terminal on the SmartAXIS can be designated as a stop or reset input to control the SmartAXIS operation.

Remote I/O

When the number of SmartAXIS inputs and outputs is insufficient, the number of inputs and outputs can be expanded to a maximum of 192 points by connecting additional SmartAXIS as remote I/O slaves over Ethernet. With the remote I/O function, the analog inputs on the SmartAXIS that are connected as remote I/O slaves can also be used.

Analog Input

Analog input of 0 to 10V DC can be converted to a digital value of 0 to 1000. A maximum of eight inputs can be used as analog inputs (not including remote I/O slaves analog inputs).

Forced I/O

The inputs and outputs of the SmartAXIS can be forced on or off. This function can be used to check the I/O wiring or the user program operation.

Pulse I/O Functions

High-speed Counter

This function counts high-speed pulse inputs that cannot be measured in normal user program processing.

Use this function for applications such as positioning control with a rotary encoder or motor control. The SmartAXIS can use single-phase high-speed counters and two-phase high-speed counters. A maximum of six single-phase high-speed counters and a maximum of two two-phase high-speed counters can be used simultaneously.

Example: Controlling a motor by counting two-phase pulse input with a high-speed counter

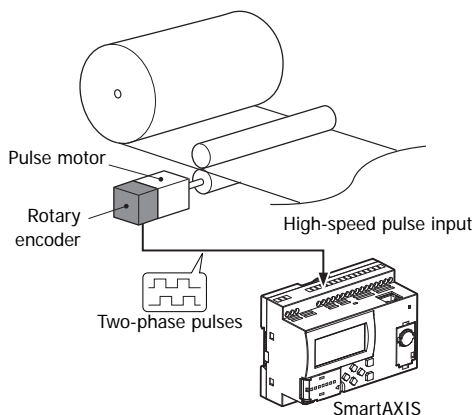

Positioning Control

The SmartAXIS can perform positioning control with pulse outputs. The SmartAXIS features the PULS instructions that can generate pulse outputs with configured frequency at the fixed pulse width ratio, pulse-width modulation (PWM) instructions that can generate pulse outputs with configured pulse width ratio at a fixed frequency, RAMP instructions for trapezoidal control, ZRN instructions for zero return operation, and ARAMP instructions that can generate pulse outputs according to a table in which the changes of the frequency are configured.

Example: Pulse output by the RAMP instruction

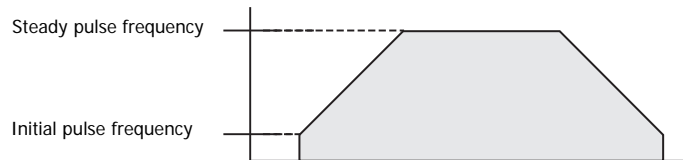

Frequency Measurement

This function measures the frequency of pulses input to an input terminal. The frequencies of a maximum of six inputs can be measured.

Convenient Functions

Calendar/Clock

The SmartAXIS features a real-time clock on-board. Using the calendar and clock function, the SmartAXIS can operate according to the current date and time. These functions can be used to control a time schedule for lighting or air conditioning equipments.

User Program Read/Write Protection

The user program in the SmartAXIS can be protected against reading and/or writing by including a password in the user program. This function is effective for security of user programs.

"Keep" or "Clear" Designation of SmartAXIS Data

Internal relays, shift register bits, counter current values, and data register values can be designated to be kept or cleared when the SmartAXIS is powered down. All or a specified range of these devices can be designated as keep or clear types.

RUN/STOP Selection at Startup when "Keep" Data is Lost

When the backup battery is dead, all data to be kept are lost. The user can select whether the SmartAXIS starts to run or not to prevent undesirable operation at the startup.

Log Data

Device values of the SmartAXIS can be saved as CSV files on the SD memory card. The DLOG instruction saves device values to the SD memory card. The TRACE instruction accumulates device values at each scan and saves them to the SD memory card at the desired timing.

Constant Scan Time

The variations in scan time that occur when the user program is running can be made constant.

Timer Interrupt

The timer interrupt can be used to call an interrupt program at a predetermined interval of time without being affected by the scan time. This can only be used when ladder program is selected as the programming language.

Communication Functions

The SmartAXIS features a variety of communication functions.

RS232C and RS485 communication of SmartAXIS is possible by installing the RS232C or RS485 communication cartridges into the expansion communication ports on the SmartAXIS module. The 24-, 40-, and 48-I/O types also feature an Ethernet port as standard, enabling communication over Ethernet.

Communication Functions

Maintenance Communication (Chapter 9)	Maintenance communication enables you to check the operating status and I/O status of the SmartAXIS, monitor and change device values, and download and upload user programs using a computer or operator interface.
User Communication (Chapter 10)	The SmartAXIS can communicate with external devices equipped with RS232C, RS485, or Ethernet ports using user communication. This can only be used when ladder program is selected as the programming language.
Modbus Communication (Chapter 11)	The SmartAXIS can send and receive data with Modbus compliant devices on RS232C, RS485, or the Ethernet port.

For details on the communications functions, refer to the chapter for each function.

Communication Ports

USB Port	Maintenance communication can be performed by connecting the SmartAXIS and a computer with USB.
Ethernet Port	The SmartAXIS can communicate with Ethernet devices such as computers and operator interfaces. Maintenance communication, user communication, Modbus communication, and remote I/O are possible.
Expansion Communication Ports	Maintenance communication, user communication, and Modbus RTU communication are possible.

Expansion Communication Ports

The SmartAXIS can perform RS232C/RS485 communication by installing RS232C or RS485 communication cartridges to the expansion communication ports on the SmartAXIS. The expansion communication ports are available on 24-, 40-, and 48-I/O types.

Example: 40-I/O type

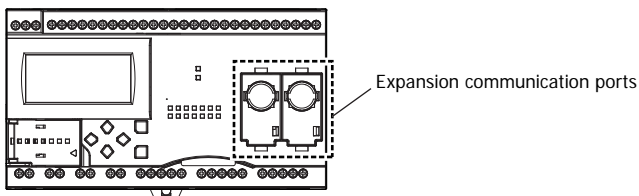

Maintenance Communication

The maintenance communication of the SmartAXIS enables you to check the operating status and I/O status of the SmartAXIS, monitor and change device values, and download and upload user programs with the PLC programming software WindLDR installed on a computer. For details on maintenance communication, see "Maintenance Communication" on page 9-1.

Supported ports: USB port, Ethernet port, and expansion communication ports

- **1:1 Maintenance Communication System**

This example shows a 1:1 maintenance communication system in which a SmartAXIS and a computer are connected with USB. The USB maintenance cable (HG9Z-XCM42) is used.

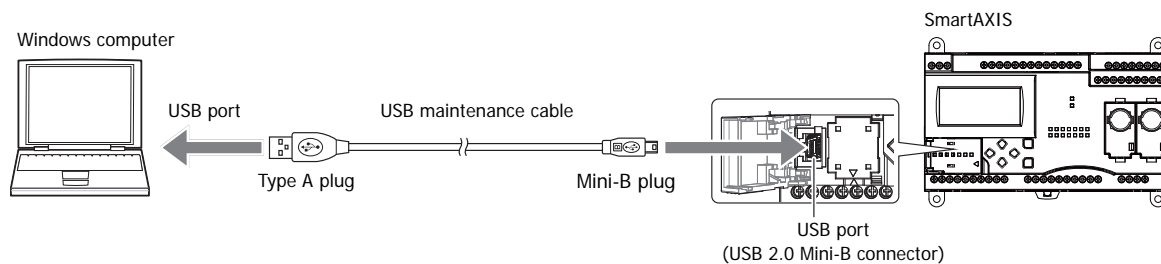

- **1:N Maintenance Communication System**

This example shows a 1:N maintenance communication system in which three SmartAXIS and a computer are connected over Ethernet. The Ethernet cables are connected to the Ethernet ports of three SmartAXIS, and those SmartAXIS are connected to the computer via an Ethernet hub.

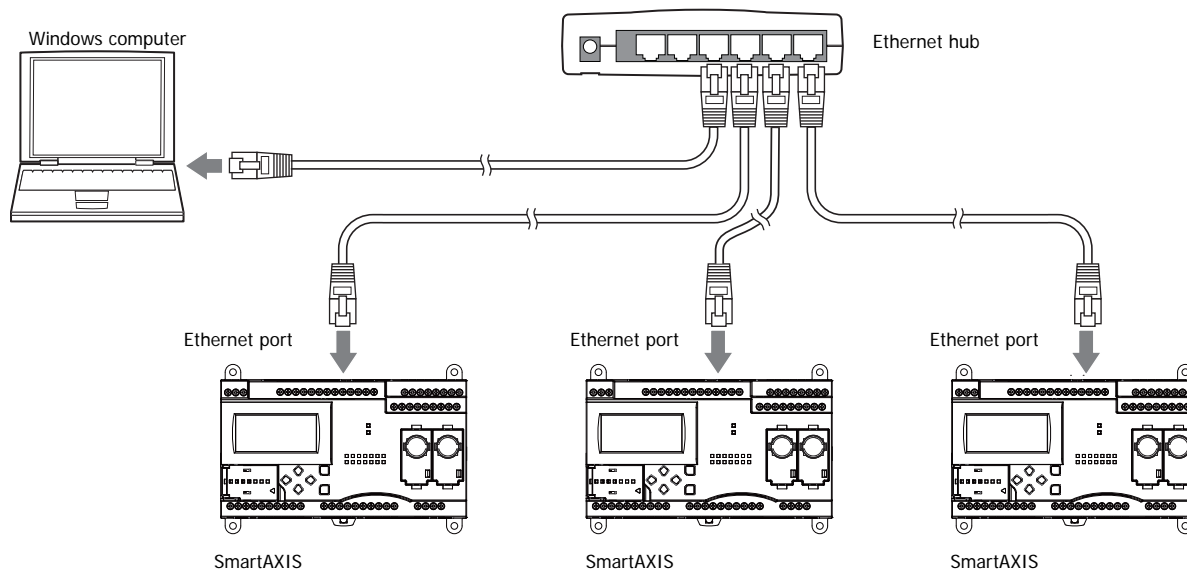

User Communication

The user communication of the SmartAXIS enables you to control external devices such as computers, printers, and barcode readers. For details on user communication, see "User Communication Instructions" on page 10-1.

Supported ports: Ethernet port and expansion communication ports

- **User Communication on RS232C**

This example shows a system in which a SmartAXIS receives the data read by a barcode reader. The RS232C communication cartridge (FT1A-PC1) is installed in a SmartAXIS expansion communication port, and then the barcode reader is connected to the RS232C port.

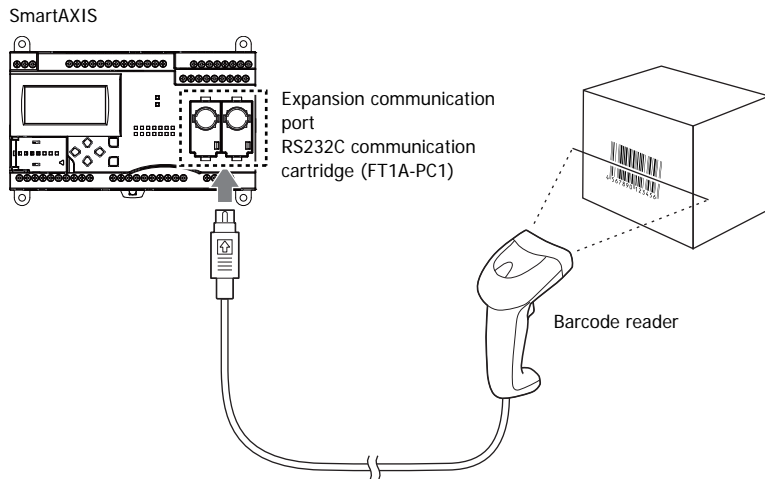

Modbus Communication

The SmartAXIS is compliant with Modbus protocol and can be used as either a Modbus communication master or slave. When used as a Modbus master, the SmartAXIS can monitor and modify the data of Modbus compliant devices, such as inverters and temperature controllers, using Modbus communication.

For details on Modbus communication, see "Modbus Communication" on page 11-1.

Supported ports: Ethernet port and expansion communication ports

- **Modbus Communication on RS485**

This example shows a system in which a SmartAXIS is communicating with a temperature controller and an inverter that support Modbus RTU. The RS485 communication cartridge (FT1A-PC3) is installed in an expansion communication port on the SmartAXIS.

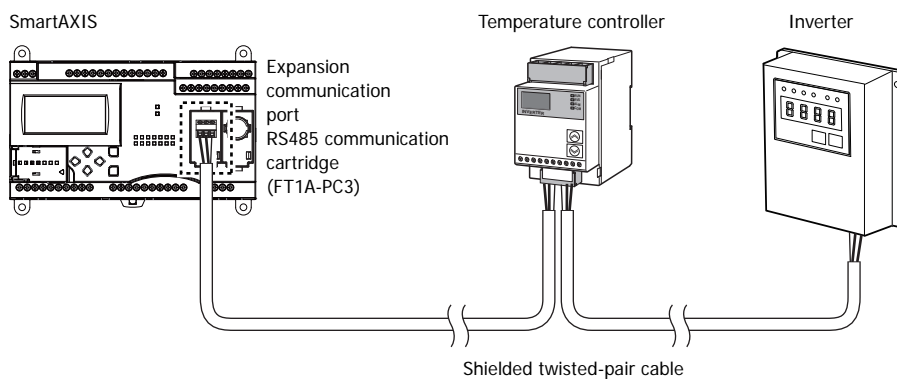

Remote I/O

The remote I/O of the SmartAXIS enables you to expand the number of inputs and outputs by connecting separate SmartAXIS modules over Ethernet as remote I/O slaves when you run out of inputs and outputs. The SmartAXIS remote I/O master can use the digital inputs and outputs and analog inputs on the remote I/O slaves.

This function can be used on the Ethernet port only. Remote I/O cannot be used with the expansion communication ports (RS232C and RS485).

• Remote I/O System Example

A SmartAXIS is connected to an Ethernet network as a remote I/O master. Two other SmartAXIS are used as remote I/O slaves. Up to a maximum of 3 SmartAXIS can be connected to a remote I/O master as remote I/O slaves.

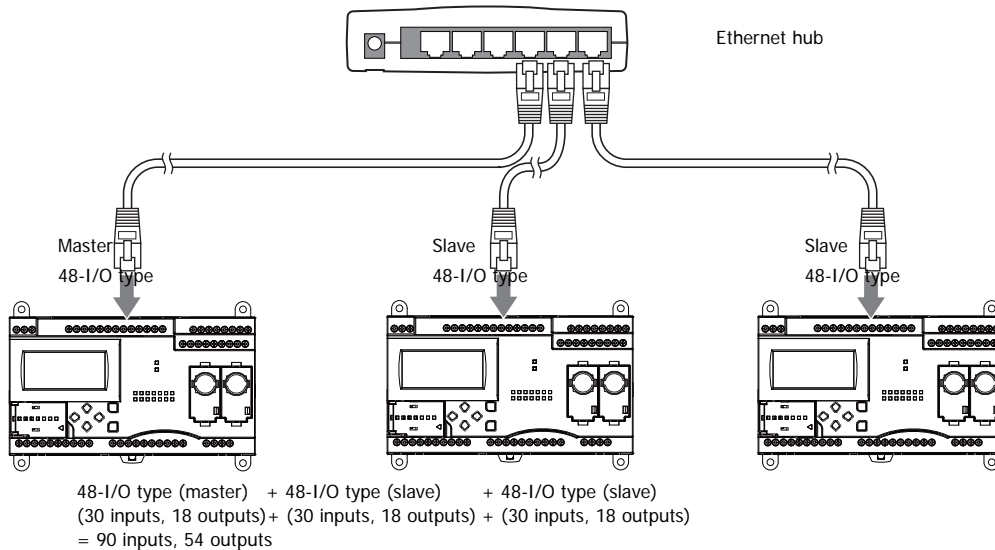

Ethernet Communication

The SmartAXIS can be connected to the Ethernet network via Ethernet port and communicate with network devices over Ethernet. The SmartAXIS has three TCP/IP connections that can be used for Ethernet communication functions. Each of these connections can simultaneously be used for a different communication protocol. Each connection can be configured for maintenance communication, user communication, Modbus TCP, or remote I/O master.

• Ethernet Communication Example

This example shows a system in which a SmartAXIS communicates with another SmartAXIS, an operator interface, and a computer simultaneously over Ethernet. Among the three connections the SmartAXIS has, Connection 1 is configured as maintenance communication for the computer to communicate with the SmartAXIS. Connection 2 is configured as Modbus TCP server for the operator interface to communicate with the SmartAXIS. Connection 3 is configured as the remote I/O master to communicate with another SmartAXIS.

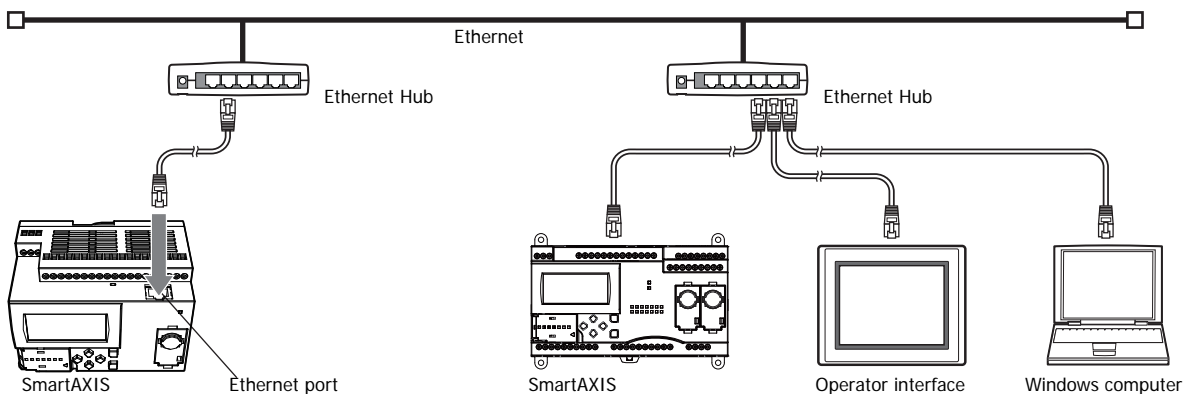

Notes:

- When accessing the SmartAXIS over the Internet, adequate safety measures are required. Be sure to consult your network administrator or Internet service provider. IDEC bears no responsibility for damages or problems caused due to security in Ethernet communication.
- Restrict the access to SmartAXIS with IP addresses and ports by using appropriate measures such as the firewall.

Operator Interface Connectivity

The SmartAXIS can perform maintenance communication with IDEC operator interfaces using the Ethernet port and expansion communication ports. Device values of the SmartAXIS can be monitored and modified with the connected operator interface. An Ethernet cable or an O/I communication cable (see Note) is used to connect the SmartAXIS and the operator interface.

For details on communication settings, refer to the operator interface manuals.

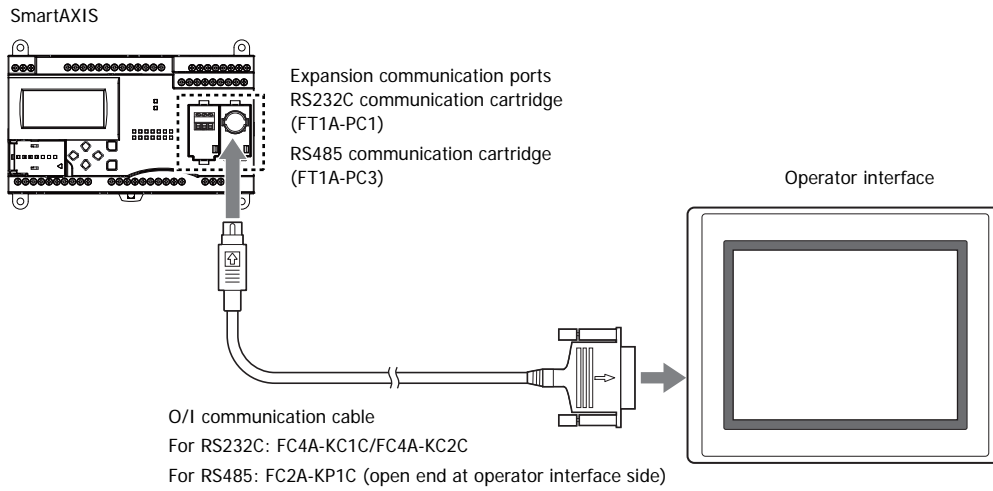

Note: For details on O/I communication cables, see "Cables" on page A-8.

2: PRODUCT SPECIFICATIONS

Introduction

This chapter describes part names and specifications of the SmartAXIS.

SmartAXIS is available in 12-, 24-, 40-, and 48-I/O types. The 12-I/O type has 8 input and 4 output terminals, the 24-I/O type has 16 input and 8 output terminals, the 40-I/O type has 24 input and 16 output terminals, and the 48-I/O type has 30 input and 18 output terminals. The 24-, 40-, and 48-I/O types have 1 or 2 port connectors to install an optional RS232C or RS485 communication cartridge for maintenance communication, user communication, or Modbus RTU communication. The 24-, 40-, and 48-I/O types have built-in Ethernet port for maintenance communication, user communication, Modbus TCP, or Remote I/O. The 40- and 48-I/O types have SD memory card slot to install an SD memory card for logging the device data. Every type of SmartAXIS has a cartridge connector to install an optional memory cartridge.

Parts Description

SmartAXIS Pro

Example: FT1A-H48KA

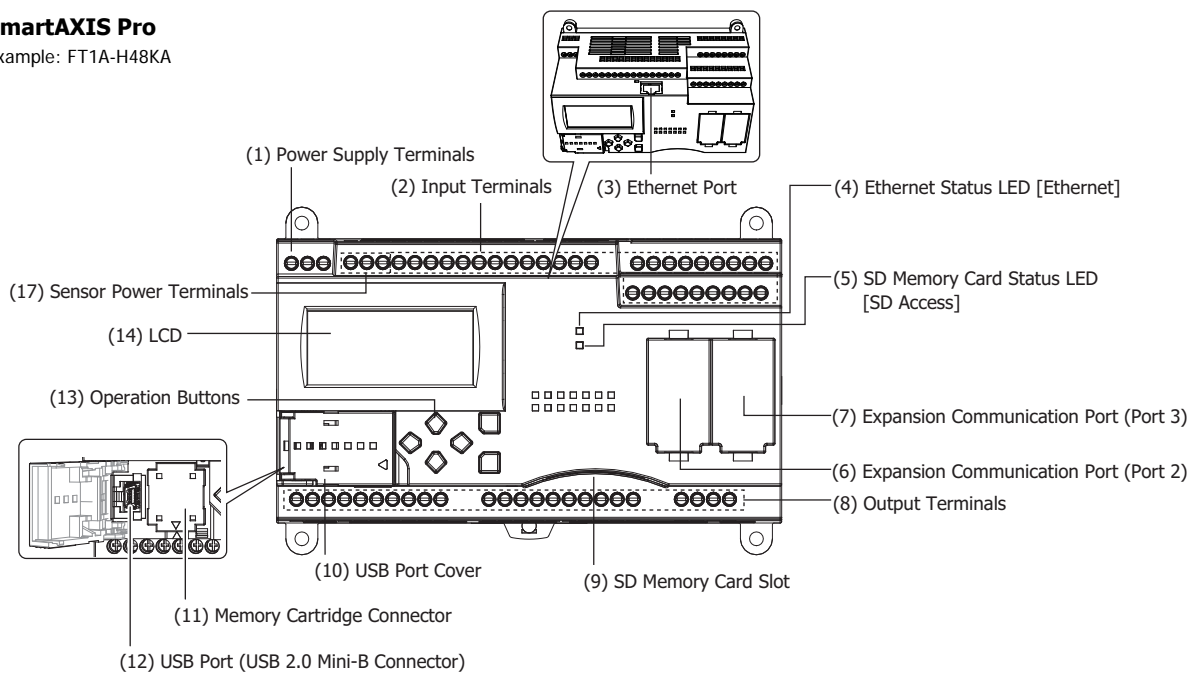

SmartAXIS Lite

Example: FT1A-B48KA

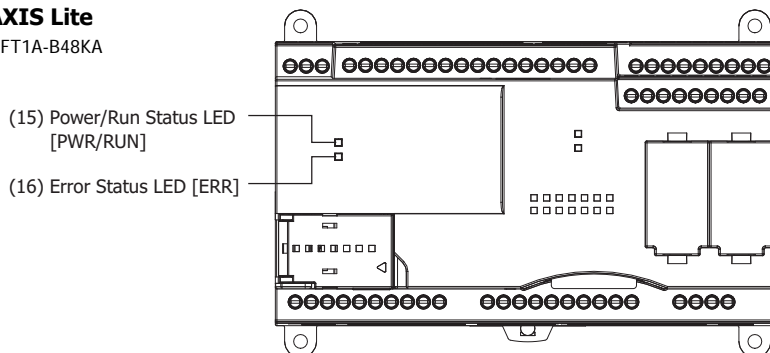

The text in square brackets is printed on the SmartAXIS to describe LED.

(1) Power Supply Terminals

Connect power supply to these terminals.

(2) Input Terminals

For connecting input signals from input devices such as sensors and pushbuttons.

DC power type can use high-speed input of up to 100 kHz and 0 to 10V DC analog input, which is shared with digital input.

2: PRODUCT SPECIFICATIONS

(3) Ethernet Port

This port is used for Ethernet connection. An Ethernet cable can be connected to enable the SmartAXIS to communicate with network devices, such as computers or PLCs. Not available on the 12-I/O type.

(4) Ethernet Status LED [Ethernet]

Turns on or blinks when an Ethernet cable is connected to the SmartAXIS and the SmartAXIS communicates with network devices. Not available on the 12-I/O type.

Ethernet Status LED	Status
OFF	Ethernet cable is not connected.
ON	Ethernet cable is connected and communication is possible.
Flashing	Ethernet cable is connected and data is being sent or received.

(5) SD Memory Card Status LED [SD Access]

Turns on or blinks when the SD memory card is being accessed. Not available on the 12- or 24-I/O type.

SD Memory Card Status LED	Status
OFF	<ul style="list-style-type: none">When the SD memory card is not insertedWhen an unsupported or unformatted SD memory card was insertedWhen access to the SD memory card was stopped by SD memory card access stop flag (M8076)When the SmartAXIS power is off
ON	The standby state where the SD memory card can be written or read
Slow Flash (1-sec interval)	<ul style="list-style-type: none">When the SmartAXIS is recognizing the SD memory cardWhen the SmartAXIS is stopping access due to SD memory card access stop flag (M8076) turning on (slow flashing, then off)
Quick Flash (100ms interval)	Reading or writing to the SD memory card

(6) Expansion Communication Port (Port2)

(7) Expansion Communication Port (Port3)

This port is used to install a communication cartridge for communication with external devices. The 24-I/O type has one expansion communication port while the 40- and 48-I/O types have two. Not available on the 12-I/O type.

(8) Output Terminals

For connecting output signals to output devices such as electromechanical relays and solenoid valves. Relay output (10A and 2A types) and transistor output (sink/source) are available.

(9) SD Memory Card Slot

Insert SD memory card to this slot. Not available on the 12- or 24-I/O type.

(10) USB Port Cover

Protects the USB port and the memory cartridge. If the panel mount USB extension cable is to be connected permanently, it can be secured to the USB port cover using a cable tie.

(11) Memory Cartridge Connector

For connecting an optional memory cartridge.

(12) USB Port

A Mini-B type USB 2.0 connector. A USB maintenance cable or panel mount USB extension cable can be attached and connected to a PC to download and upload user programs using WindLDR.

(13) Operation Buttons

For operating the menus displayed on the LCD to access functions. There are six operation buttons: [\triangle], [∇], [\triangleright], [\triangleleft], [OK], and [ESC].

Not available on the SmartAXIS Lite.

(14) LCD

Displays operation menus, status, and setting of the SmartAXIS. Not available on the SmartAXIS Lite.

(15) Power/Run Status LED [PWR/RUN]

A green LED that turns on or flashes to indicate the power supply and operation status.

Power/Run Status LED	Status
OFF	Power is not supplied.
ON	Power is supplied and the user program is being executed.
Slow Flash (1-sec interval)	Power is supplied and the user program is stopped.

Not available on the SmartAXIS Pro.

(16) Error Status LED [ERR]

A red LED that turns on if an error occurs.

Error Status LED	Status
OFF	Normal operation
ON	An error has occurred.
Slow Flash (1-sec interval)	The SmartAXIS is running and the forced I/O function is enabled.
Quick Flash (100 ms interval)	The user program is stopped and the forced I/O function is enabled.

Not available on the SmartAXIS Pro.

(17) Sensor Power Terminals

For supplying power to sensors (24V DC). Not available on the DC power type.

2: PRODUCT SPECIFICATIONS

General Specifications

AC Power Type

Type Number	FT1A-			
	H12RC, B12RC	H24RC, B24RC	H40RC, B40RC	H48KC, H48SC B48KC, B48SC
Normal Operating Conditions				
Operating Temperature	0 to +55°C (operating ambient temperature) (Note 2)			
Storage Temperature	-25 to +70°C (no freezing)			
Relative Humidity	10 to 95% (non-condensing, operating and storage humidity)			
Pollution Degree	2 (IEC60664-1)			
Degree of Protection	IP20 (IEC60529)			
Corrosion Immunity	Atmosphere free from corrosive gases			
Altitude	Operation: 0 to 2,000m (0 to 6,565 feet)			
	Transport: 0 to 3,000m (0 to 9,840 feet)			
Installation Location	Inside cabinet (Note 1)			
Device Class	Open equipment			
Overvoltage Category	II			
Vibration Resistance	When mounted on a DIN rail or panel surface: 5 to 8.4Hz amplitude 3.5mm, 8.4 to 150Hz acceleration 9.8m/s ² (1G) 2 hours per axis on each of three mutually perpendicular axes			
Shock Resistance	147 m/s ² (15G), 11ms duration, 3 shocks per axis on three mutually perpendicular axes			
Power Supply (Note 3)				
Rated Power Voltage	100 to 240V AC			
Allowable Voltage Range	85 to 264V AC			
Rated Power Frequency	50/60Hz (47 to 63Hz)			
Maximum Power Consumption	18VA	41VA	48VA	43VA
Allowable Momentary Power Interruption	10ms maximum (at the rated power voltage)			
Dielectric Strength Voltage	Between power and PE terminals: 1,500V AC, 1 minute			
	Between input and PE terminals: 1,500V AC, 1 minute			
	Between transistor output and PE terminals: 1,500V AC, 1 minute			
	Between relay output and PE terminals: 2,300V AC, 1 minute			
	Between power and input terminals: 1,500V AC, 1 minute			
	Between power and transistor output terminals: 1,500V AC, 1 minute			
	Between power and relay output terminals: 2,300V AC, 1 minute			
	Between input and transistor output terminals: 1,500V AC, 1 minute			
Between input and relay output terminals: 2,300V AC, 1 minute				
EMC Immunity	IEC/EN 61131-2:2007 compliant			
Inrush Current	35A maximum (Cold start with T _a = 25°C, 200V AC)			
Ground	D-type ground (Class 3 ground)			
Grounding Wire	UL1007 AWG16			
Power Supply Wire	UL1015 AWG22, UL1007 AWG18			
Effect of Improper Power Supply Connection	Reverse polarity: Normal operation			
	Improper voltage or frequency: Permanent damage may be caused			
	Improper lead connection: Permanent damage may be caused			
Weight	Approx. 230g	Approx. 400g	Approx. 580g	Approx. 540g

Note 1: Use in environments that satisfy product specifications.

Note 2: UL, c-UL Listed at 0 to +50°C (FT1A Version V110).

Note 3: Supports input/output overvoltage protection. When overvoltage protection occurred, the power supply output is shut off. In this situation, shut off the AC input, wait for one minute or longer, and then turn on the AC input again.

DC Power Type

Type Number	FT1A-			
	H12RA, B12RA	H24RA, B24RA	H40RKA, H40RSA B40RKA, B40RSA	H48KA, H48SA B48KA, B48SA
Normal Operating Conditions				
Operating Temperature	0 to +55°C (operating ambient temperature) (Note 2)			
Storage Temperature	-25 to +70°C (no freezing)			
Relative Humidity	10 to 95% (non-condensing, operating and storage humidity)			
Pollution Degree	2 (IEC60664-1)			
Degree of Protection	IP20 (IEC60529)			
Corrosion Immunity	Atmosphere free from corrosive gases			
Altitude	Operation: 0 to 2,000m (0 to 6,565 feet)			
	Transport: 0 to 3,000m (0 to 9,840 feet)			
Installation Location	Inside cabinet (Note 1)			
Device Class	Open equipment			
Overvoltage Category	II			
Vibration Resistance	When mounted on a DIN rail or panel surface: 5 to 8.4Hz amplitude 3.5 mm, 8.4 to 150Hz acceleration 9.8m/s ² (1G) 2 hours per axis on each of three mutually perpendicular axes			
Shock Resistance	147m/s ² (15G), 11 ms duration, 3 shocks per axis on three mutually perpendicular axes			
Power Supply				
Rated Power Voltage	24V DC			
Allowable Voltage Range	20.4 to 28.8V DC (Including ripple voltage)			
Maximum Power Consumption	4.3W	4.8W	7.9W	6.0W
Allowable Momentary Power Interruption	10ms maximum (Rated voltage, PS2)			
Dielectric Strength Voltage	Between power/input and FE terminals: 500V AC, 1 minute			
	Between transistor output and FE terminals: 500V AC, 1 minute			
	Between relay output and FE terminals: 2,300V AC, 1 minute			
	Between power/input and transistor output terminals: 500V AC, 1 minute			
	Between power/input and relay output terminals: 2,300V AC, 1 minute			
EMC Immunity	IEC/EN 61131-2:2007 compliant			
Inrush Current	30A maximum			
Ground	D-type ground (Class 3 ground)			
Grounding Wire	UL1007 AWG16			
Power Supply Wire	UL1015 AWG22, UL1007 AWG18			
Effect of Improper Power Supply Connection	Reverse polarity: No operation, no damage			
	Improper voltage or frequency: Permanent damage may be caused			
	Improper lead connection: Permanent damage may be caused			
Weight	Approx. 190g	Approx. 310g	Approx. 420g	Approx. 380g

Note 1: Use in environments that satisfy product specifications.

Note 2: UL, c-UL Listed at 0 to +50°C (FT1A Version V110).

2: PRODUCT SPECIFICATIONS

Function Specifications

Function Specifications

Type Number		FT1A-																																																													
		H12RA B12RA	H12RC B12RC	H24RA B24RA	H24RC B24RC	H40RKA H40RSA B40RKA B40RSA	H40RC B40RC	H48KA H48SA B48KA B48SA	H48KC H48SC B48KC B48SC																																																						
Program Capacity (Note 1)	Ladder	12,000 bytes (3,000 steps)			47,400 bytes (11,850 steps)																																																										
	FBD	10,000 bytes			38,000 bytes																																																										
Number of Function Blocks (Note 2)	Block (B)	200			1,000																																																										
	Timer (T)	100			200																																																										
	Counter (C)	100			200																																																										
Input Points		8		16		24		30																																																							
Digital Input (Terminal No.)		6 (10 to 15)	8 (10 to 17)	12 (10 to 17, 110 to 113)	16 (10 to 17, 110 to 117)	18 (10 to 17, 110 to 117, 120, 121)	24 (10 to 17, 110 to 117, 120 to 127)	22 (10 to 17, 110 to 117, 120 to 125)	30 (10 to 17, 110 to 117, 120 to 127, 130 to 135)																																																						
Shared Analog Input (Terminal No.)		2 (16, 17)	—	4 (114 to 117)	—	6 (122 to 127)	—	8 (126, 127, 130 to 135)	—																																																						
Output Points		4		8		16		18																																																							
10A Relay Output (Terminal No.)		4 (Q0 to Q3)						—																																																							
2A Relay Output (Terminal No.)		—		4 (Q4 to Q7)		8 (Q4 to Q7, Q10 to Q13)	12 (Q4 to Q7, Q10 to Q13, Q14 to Q17)	—																																																							
Transistor Output (Terminal No.)		—		—		4 (Q14 to Q17)	—	18 (Q0 to Q7, Q10 to Q17, Q20, Q21)																																																							
User Program Storage		Flash ROM (10,000 rewriting life)																																																													
Backup Function		<table border="1"> <tr> <td>RAM</td> <td colspan="8">Backup data: Internal relay, shift register, counter current value, data register (Note 3), clock data (year, month, and day)</td> </tr> <tr> <td>Backup Duration</td> <td colspan="8">Approx. 30 days (typical) at 25°C after backup battery fully charged</td> </tr> <tr> <td>Battery</td> <td colspan="8">Lithium secondary battery</td> </tr> <tr> <td>Charging Time</td> <td colspan="8">Approx. 15 hours for charging from 0% to 90% of full charge</td> </tr> <tr> <td>Battery Life</td> <td colspan="8">5 years in cycles of 9-hour charging and 15-hour discharging</td> </tr> <tr> <td>Replaceability</td> <td colspan="8">Not possible to replace battery</td> </tr> </table>								RAM	Backup data: Internal relay, shift register, counter current value, data register (Note 3), clock data (year, month, and day)								Backup Duration	Approx. 30 days (typical) at 25°C after backup battery fully charged								Battery	Lithium secondary battery								Charging Time	Approx. 15 hours for charging from 0% to 90% of full charge								Battery Life	5 years in cycles of 9-hour charging and 15-hour discharging								Replaceability	Not possible to replace battery							
RAM	Backup data: Internal relay, shift register, counter current value, data register (Note 3), clock data (year, month, and day)																																																														
Backup Duration	Approx. 30 days (typical) at 25°C after backup battery fully charged																																																														
Battery	Lithium secondary battery																																																														
Charging Time	Approx. 15 hours for charging from 0% to 90% of full charge																																																														
Battery Life	5 years in cycles of 9-hour charging and 15-hour discharging																																																														
Replaceability	Not possible to replace battery																																																														
Clock Function (Note 4)		Clock accuracy: ±30 sec/month (typical) at 25°C																																																													
Control System		Stored program system																																																													
Instruction Words (Ladder)		<table border="1"> <tr> <td>Basic Instructions</td> <td colspan="2">42</td> <td colspan="6"></td> </tr> <tr> <td>Advanced Instructions</td> <td>99</td> <td>107</td> <td colspan="6">DC type: 125, AC type: 111</td> </tr> </table>								Basic Instructions	42								Advanced Instructions	99	107	DC type: 125, AC type: 111																																									
Basic Instructions	42																																																														
Advanced Instructions	99	107	DC type: 125, AC type: 111																																																												
Function Block (FBD)		<table border="1"> <tr> <td>Function Blocks</td> <td colspan="8">45</td> </tr> </table>								Function Blocks	45																																																				
Function Blocks	45																																																														
Processing Time		<table border="1"> <tr> <td rowspan="2">Ladder</td> <td>Basic Instruction</td> <td colspan="7">0.95 ms (1000 steps)</td> </tr> <tr> <td>END Processing</td> <td colspan="7">640 μs</td> </tr> <tr> <td rowspan="2">FBD</td> <td>Logical Operation FB Execution Time</td> <td colspan="7">1.3 ms (100 FBs)</td> </tr> <tr> <td>Scan End Processing</td> <td colspan="7">1 ms</td> </tr> </table>								Ladder	Basic Instruction	0.95 ms (1000 steps)							END Processing	640 μs							FBD	Logical Operation FB Execution Time	1.3 ms (100 FBs)							Scan End Processing	1 ms																										
Ladder	Basic Instruction	0.95 ms (1000 steps)																																																													
	END Processing	640 μs																																																													
FBD	Logical Operation FB Execution Time	1.3 ms (100 FBs)																																																													
	Scan End Processing	1 ms																																																													
Internal Relay		1024																																																													
Shift Register		128																																																													

Type Number	FT1A-							
	H12RA B12RA	H12RC B12RC	H24RA B24RA	H24RC B24RC	H40RKA H40RSA B40RKA B40RSA	H40RC B40RC	H48KA H48SA B48KA B48SA	H48KC H48SC B48KC B48SC
Data Register	12-I/O type: 400 24-I/O type, 40-I/O type, 48-I/O type: 2,000							
Counter (adding, reversible)	100		200					
Timer (1-sec, 100ms, 10ms, 1ms)	100		200					
Input Filter	Without filter, 3 to 15ms (selectable in increments of 1ms)							
Catch Input/Interrupt Input								
Input Points	4		6					
Self-diagnostic Function	Keep data Power failure Clock error Watchdog timer Timer/counter preset value change error User program syntax User program execution System error Memory cartridge transfer error							
High-speed Counter								
Points	Total 4 points	—	Total 6 points	—	Total 6 points	—	Total 6 points	—
Maximum Counter Frequency	Single/two-phase selectable: 100kHz (2 points) Single-phase: 100kHz (2 points)		Single/two-phase selectable: 100kHz (2 points) Single-phase: 100kHz (4 points)					
Counting Range	0 to 4,294,967,295 (32 bits)							
Operation Mode	Rotary encoder mode and adding counter mode							
Pulse Output (Maximum frequency: 100kHz)								
Points	—		2 (Q14, Q15)		—		2 (Q14, Q15)	
Pulse Output (Maximum frequency: 5kHz)								
Points	—		2 (Q16, Q17)		—		2 (Q16, Q17)	
Analog Voltage Input								
Points (Terminal No.)	2 (I16, I17)	—	4 (I14 to I17)	—	6 (I22 to I27)	—	8 (I26, I27, I30 to I35)	—
Input voltage Range	0 to 10V DC							
Digital Resolution	0 to 1000							
USB Port								
Points	1							
USB Standard	USB 2.0							
Connector	Mini-B type							
Expansion Communication Ports								
Points	—		1		2			
Ethernet Port								
Points	—		1					
Memory Cartridge Connectors								
Points	1							
SD Memory Card Slots								
Points	—		1					

Note1: 1 step is equivalent to 4 bytes.

Note2: When FBD program is selected as the programming language.

Note3: Among data registers D0 to D1999, only D0 to D999 are backed up.

Note4: Set the calendar/clock using WindLDR to use the clock function.

2: PRODUCT SPECIFICATIONS

LCD Specifications (SmartAXIS Pro only)

	Description/Specifications
Type	STN monochrome LCD
Resolution	64 x 192 pixels
Number of Characters	24 digits x 8 lines (8 x 8 pixel font) 12 digits x 8 lines (16 x 8 pixel font) 12 digits x 4 lines (16 x 16 pixel font)
Display Content	System menus, messages, operation status monitor
Contrast Adjustment	Not possible
Backlight	Yes (backlight can be turned on and off)

Input Specifications (AC Power Type)

Type Number	FT1A-			
	H12RC B12RC	H24RC B24RC	H40RC B40RC	H48KC H48SC B48KC B48SC
Input Points	8	16	24	30
Rated Input Voltage	24V DC			
Input Voltage Range	0 to 28.8V DC			
Terminal Arrangement	See "Terminal Arrangement" on page 2-16.			
Input External Power Supply Voltage Fluctuation Range/Capacity (Note 1)	—	DC20.4 to 26.4V 250mA	DC20.4 to 26.4V 300mA	DC20.4 to 26.4V 300mA

Digital Input

Input Type	Contacts	Sink/Source		
Input Points (Terminal No./ Common Line Name)	8 points in 1 common line (I0 to I7/COM)	16 points in 1 common line (I0 to I7, I10 to I17/COM)	24 points in 1 common line (I0 to I7, I10 to I17, I20 to I27/COM)	30 points in 2 common lines (I0 to I7, I10 to I17, I20 to I25/COMA, I26, I27, I30 to I35/COMB)
Rated Input Current	5.3mA			
Input Impedance	4.3kΩ			
Turn ON Time	40 μs + filter value			
Turn OFF Time	150 μs + filter value			
Isolation	Between input terminals: Not isolated			
	Internal circuit: Photocoupler isolated			
Input Type	Type 1 (IEC61131-2)			
Shared Digital/Analog Inputs	No			
Status Display	Pro	LCD display		
	Lite	—		
External Load for I/O Interconnection	Not needed			
Signal Determination Method	Static			
Cable Length	100m in compliance with electromagnetic immunity			
Effect of Improper Input Connection	No damage. If any input exceeding the rated value is applied, permanent damage may be caused.			

Note 1: When an overload state occurs such as a short circuit in the input external power supply, the power supplied to the internal circuit of the SmartAXIS is stopped. When the overload state is cleared, the output automatically recovers.

Input Internal Circuit

- Contact Input (FT1A-*12RC)

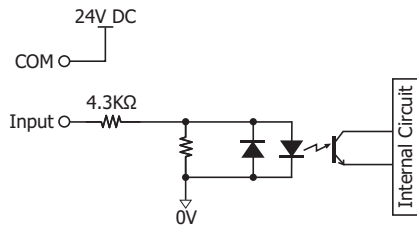

- Sink/Source Input (FT1A-*24/40/48RC)

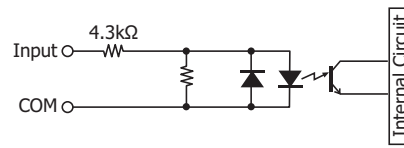

Input Operating Range

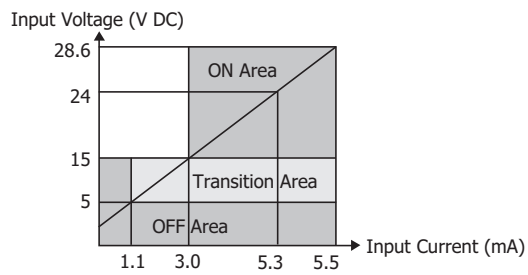

2: PRODUCT SPECIFICATIONS

Input Specifications (DC Power Type)

Type Number	FT1A-					
	H12RA B12RA	H24RA B24RA	H40RKA B40RKA	H40RSA B40RSA	H48KA B48KA	H48SA B48SA
Input Points	12	16	24		30	
Rated Input Voltage	24V DC					
Input Voltage Range	0 to 28.8V DC					
Terminal Arrangement	See "Terminal Arrangement" on page 2-16.					

Digital Input

Input Type	Sink	Source	Sink	Source	Sink	
Input Points (Terminal No. /Common Line Name)	6 points in 1 common line (I0 to I5/ Internal "-" terminal)	12 points in 1 common line (I0 to I7, I10 to I13/ Internal "-" terminal)	18 points in 1 common line (I0 to I7, I10 to I17, I20, I21/ Internal "+" terminal)	18 points in 1 common line (I0 to I7, I10 to I17, I20, I21/ Internal "-" terminal)	22 points in 1 common line (I0 to I7, I10 to I17, I20 to I25/ Internal "+" terminal)	22 points in 1 common line (I0 to I7, I10 to I17, I20 to I25/ Internal "-" terminal)
Rated Input Current	4.4mA		5.2mA	4.4mA	5.2mA	4.4mA
Input Impedance	5.5kΩ		4.7kΩ	5.5kΩ	4.7kΩ	5.5kΩ
Turn ON Time	2.5 μs + filter value	I0 to I7: 2.5μs + filter value Others: 40μs + filter value				
Turn OFF Time	5 μs + filter value	I0 to I7: 5μs + filter value Others: 150μs + filter value				
Function Input	High-Speed Counter (Two-phase)	2 systems [System 1] 1-A phase: I0, 1-B phase: I1, 1-Z phase: I2 (for clear input) [System 2] 2-A phase: I3, 2-B phase: I4, 2-Z phase: I5 (for clear input)				
	High-Speed Counter (Single-phase)	4 points (I0, I2, I3, I5)	6 points (I0, I2, I3, I5, I6, I7)			
	Interrupt	4 points (I0, I2, I3, I5)	6 points (I0, I2, I3, I5, I6, I7)			
	Catch	4 points (I0, I2, I3, I5)	6 points (I0, I2, I3, I5, I6, I7)			
	Frequency Measurement	4 points (I0, I2, I3, I5)	6 points (I0, I2, I3, I5, I6, I7)			
Isolation	Between input terminals: Not isolated					
	Internal circuit: Not isolated					
Input Type	Type 1 (IEC61131-2)					
External Load for I/O Interconnection	Not needed					
Signal Determination Method	Static					
Cable Length (in compliance with electromagnetic immunity)	3m (9.84 ft.)	I0 to I7: 3m (9.84 ft.) Others: 100m (328.1 ft.)				

Type Number	FT1A-					
	H12RA B12RA	H24RA B24RA	H40RKA B40RKA	H40RSA B40RSA	H48KA B48KA	H48SA B48SA
Analog Input						
Input Signal Type		Voltage Input				
Input Points (Terminal No. /Common Line Name)		2 points in 1 common line (I6, I7/Internal "-" terminal)	4 points in 1 common line (I14 to I17/Internal "-" terminal)	6 points in 1 common line (I22 to I27/Internal "-" terminal)	8 points in 1 common line (I26, I27, I30 to I35/Internal "-" terminal)	
Input Range		0 to 10.0V DC				
Rated Input Current		0.3mA				
Input Impedance		78.0kΩ				
Digital Resolution		0 to 1000 (10 bits)				
Data Type		Binary data: 0 to 1000				
Input Value of LSB		10mV				
Type of Input		Single-ended input				
AD Conversion	Sample Duration Time	2ms maximum				
	Sample Repetition Time	2ms maximum				
	Total Input System Transfer Time	2ms + filtering time + scan time				
Input Error	Maximum Error at 25°C	±1.5% of full scale				
	Temperature Coefficient	±0.25% of full scale/°C				
	Maximum Error	±5.0% of full scale				
General Characteristics	Operating Mode	Self-scan				
	Conversion Method	Successive Approximation				
Status Display	Pro	"Device Monitor" screen (LCD)				
	Lite	—				
Maximum Temporary Deviation during Electrical Noise Tests		±5.0% of full scale				
Recommended Cable for Noise Immunity		Twisted pair shielded cable				
Calibration or Verification to Maintain Rated Accuracy		Not possible				
Maximum Permanent Allowed Overload (No Damage)		28.8V DC				
Overload Status (Outside Input Range) Detection		Detectable (Stored in special data register D8077)				
Isolation		Between input terminals: Not isolated				
		Between input and internal circuit: Not isolated				
Used as Digital Input	Digital Input Type	— (IEC 61131-2 digital input type is not supported)				
	Input Threshold	ON voltage: 15V minimum (ON current: 0.20mA minimum) OFF voltage: 5V maximum (OFF current: 0.06mA maximum)				
Effect of Improper Input Connection		No damage. If any input exceeding the rated value is applied, permanent damage may be caused.				

2: PRODUCT SPECIFICATIONS

Digital Input Internal Circuits

- Sink Input

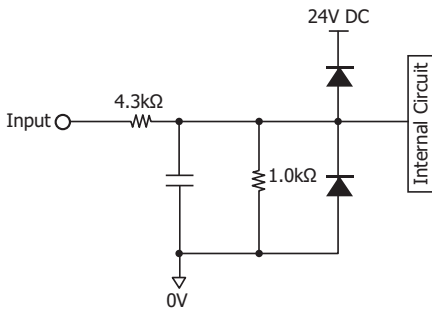

- Source Input

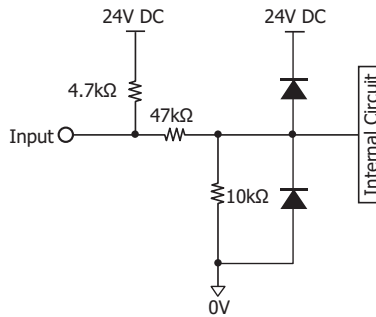

Internal Circuit with Shared Digital/Analog Input

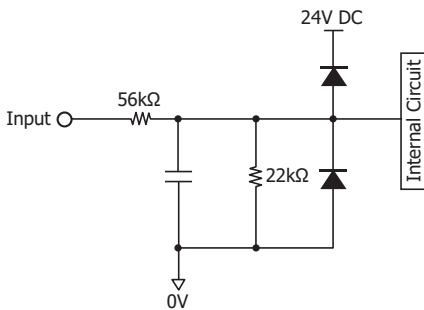

Digital Input Operating Range

- Sink Input

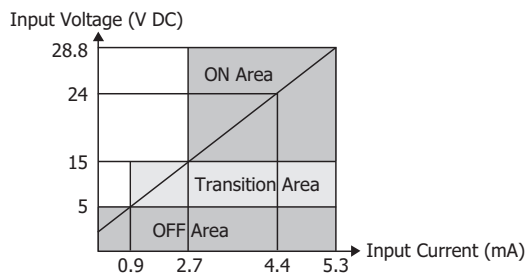

- Source Input

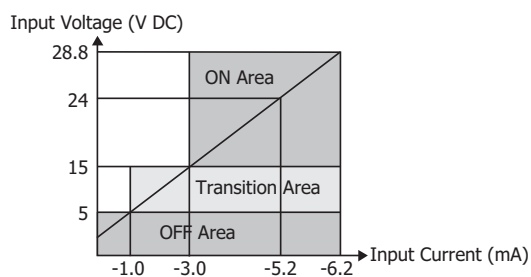

- Operating Range of Shared Digital/Analog Input

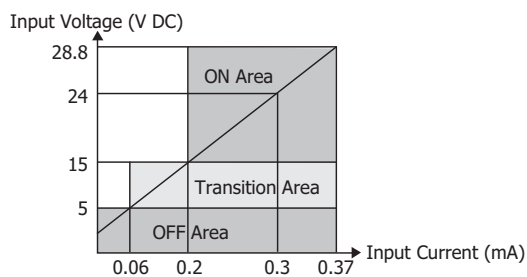

Output Specifications (10A Relay)

Type Number	FT1A-					
	H12RC B12RC	H12RA B12RA	H24RC B24RC	H24RA B24RA	H40RC B40RC	H40RKA H40RSA B40RKA B40RSA
No. of Outputs (Terminal No.)	4 (Q0 to Q3)					
Terminal Arrangement	See "Terminal Arrangement" on page 2-16.					
Output Type	1a contact					
Maximum Load Current (Note)	10A					
Minimum Switching Load	10mA/5V DC (reference value)					
Initial Contact Resistance	100mΩ maximum (1A, 6V DC)					
Electrical Life	100,000 operations minimum (rated load 1,800 operations/hour)					
Mechanical Life	20,000,000 operations minimum (no load 18,000 operations/hour)					
Rated Load (Note)	250V AC/10A, 30V DC/10A					
Dielectric Strength	Between output terminal and internal circuit: 2,300V AC, 1 minute Between output terminals (COMs): 2,300V AC, 1 minute					
Status Display	Pro	LCD display				
	Lite	—				

Note: Values for resistive/inductive load.

Output Delay

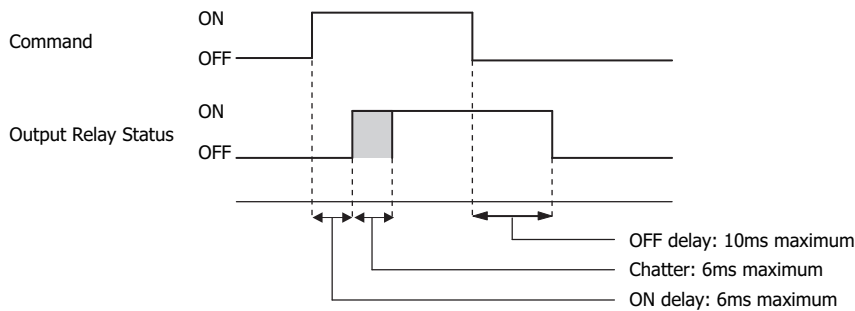

Derating

When using the SmartAXIS at an operating temperature of 45°C or higher, reduce the output current of the 10A relay and power supply voltage as shown in the figure below.

Normal Installation

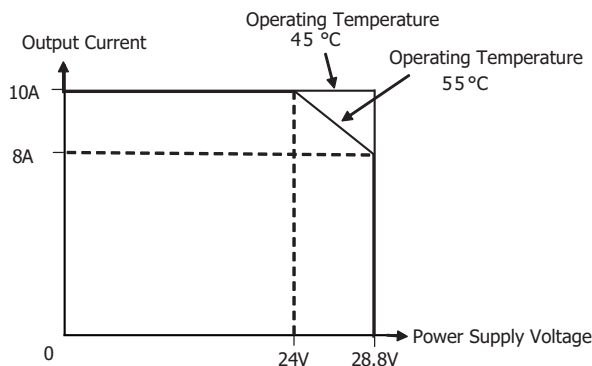

Note: UL, c-UL Listed at 0 to +50°C (FT1A Version V110).

2: PRODUCT SPECIFICATIONS

Output Specifications (2A Relay)

Type Number		FT1A-		
		H24RC B24RC H24RA B24RA	H40RC B40RC	H40RKA H40RSA B40RKA B40RSA
No. of Outputs (Terminal No.)		4 (Q4 to Q7)	12 (Q4 to Q7, Q10 to Q13, Q14 to Q17)	8 (Q4 to Q7, Q10 to Q13)
Output Points per Common Line	COM4	4 (Q4 to Q7)	4 (Q4 to Q7)	4 (Q4 to Q7)
	COM5	—	4 (Q10 to Q13)	4 (Q10 to Q13)
	COM6	—	4 (Q14 to Q17)	—
Terminal Arrangement		See "Terminal Arrangement" on page 2-16.		
Output Type		1a contact		
Maximum Load Current	1 point	2A		
	1 common line	8A maximum		
Minimum Switching Load		0.1 mA/0.1V DC (reference value)		
Initial Contact Resistance		1A, 6V DC		
Electrical Life		100,000 operations minimum (rated load 1,800 operations/hour)		
Mechanical Life		20,000,000 operations minimum (no load 18,000 operations/hour)		
Rated Load (Note)		250V AC/2A, 30V DC/2A		
Dielectric Strength		Between output terminal and internal circuit: 2,300V AC, 1 minute Between output terminals (COMs): 2,300V AC, 1 minute		
Status Display	Pro	LCD display		
	Lite	—		

Note: Values for resistive/inductive load.

Output Delay

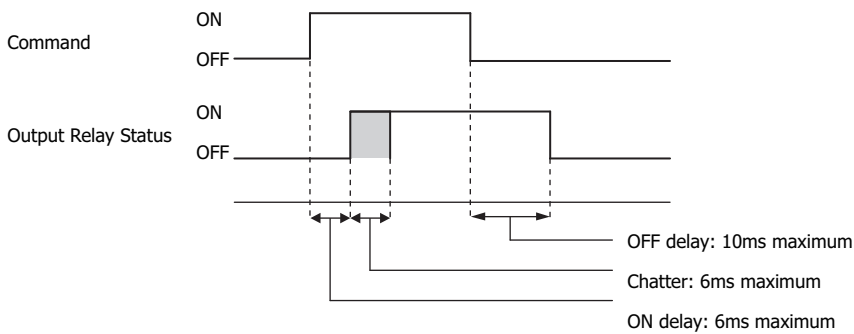

Output Specifications (Transistor)

Type Number		FT1A-						
		H40RKA B40RKA	H40RSA B40RSA	H48KC B48KC	H48SC B48SC	H48KA B48KA	H48SA B48SA	
Output	Model/ No. of Point	Sink output	4 (Q14 to Q17)	—	18 (Q0 to Q7, Q10 to Q17, Q20, Q21)	—	18 (Q0 to Q7, Q10 to Q17, Q20, Q21)	—
		Source output	—	4 (Q14 to Q17)	—	18 (Q0 to Q7, Q10 to Q17, Q20, Q21)	—	18 (Q0 to Q7, Q10 to Q17, Q20, Q21)
Output Points per Common Line		COM0	—		8 (Q0 to Q7)			
		COM1	—		8 (Q10 to Q17)			
		COM2	—		2 (Q20, Q21)			
		COM6	4 (Q14 to Q17)		—			
Rated Load Voltage		24V DC						
Operating Load Voltage Range		20.4 to 28.8V DC						
Terminal Arrangement		See "Terminal Arrangement" on page 2-16.						
Maximum Load Current	1 point	0.3A maximum						
	1 common line	1A maximum						
Voltage Drop (ON Voltage)		1V maximum (voltage between COM and output terminals when output is on)						
Inrush Current		1A maximum						
Leakage Current		0.1 mA maximum						
Clamping Voltage		39V±1V						
Maximum Lamp Load		8W						
Inductive Load		L/R = 10ms (28.8V DC, 1 Hz)						
External Current Draw		Sink output: 100mA maximum, 24V DC (power voltage at the +V terminal) Source output: 100mA maximum, 24V DC (power voltage at the +COM terminal)						
Function Input	100kHz output	2 points (Q14, Q15)						
	5kHz output	2 points (Q16, Q17)						
Isolation	Between output terminal and internal circuit	Photocoupler isolated						
	Between output terminals	Same common line: Not isolated Separate common line: Isolated						
Output Delay	Turn ON Time	High-speed output terminal (100 kHz pulse output terminal): 5 μs maximum Normal output terminal (including 5 kHz pulse output terminal): 100 μs maximum						
	Turn OFF Time	High-speed output terminal (100 kHz pulse output terminal): 5 μs maximum Normal output terminal (including 5 kHz pulse output terminal): 100 μs maximum						
Status Display	Pro	LCD display						
	Lite	—						

Output Internal Circuit

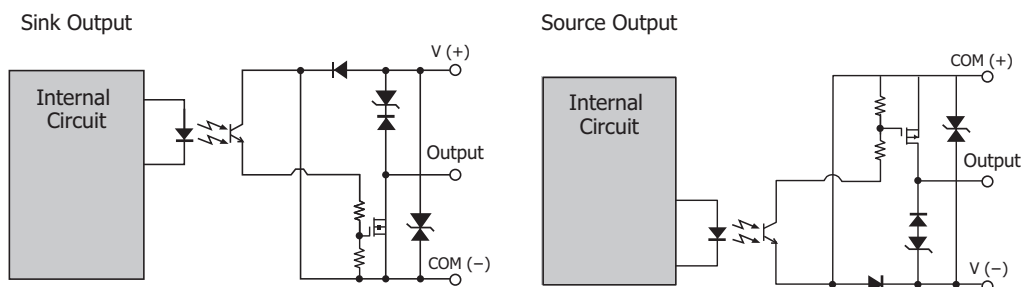

2: PRODUCT SPECIFICATIONS

Terminal Arrangement

FT1A-H12RA, FT1A-B12RA

Terminal Arrangement and I/O Wiring Diagrams

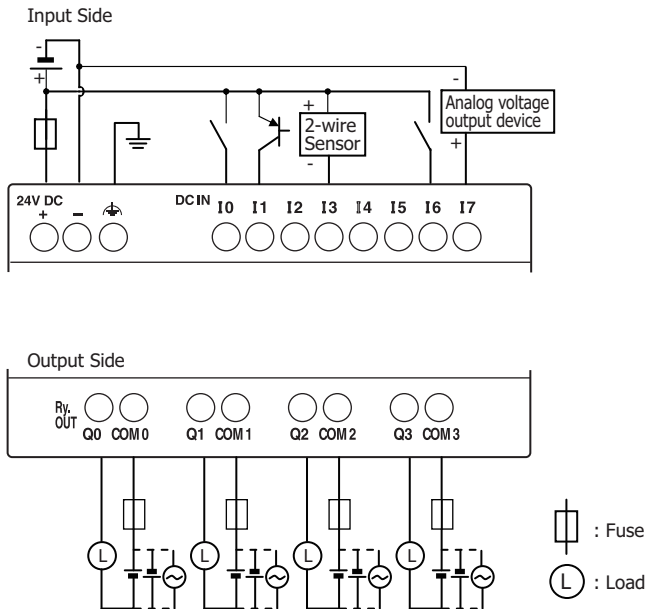

FT1A-H12RC, FT1A-B12RC

Terminal Arrangement and Wiring I/O Diagrams

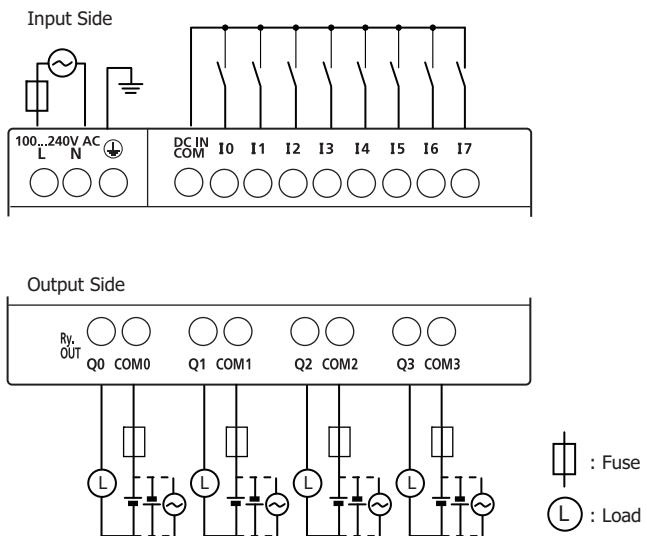

FT1A-H24RA, FT1A-B24RA

Terminal Arrangement and I/O Wiring Diagrams

Input Side

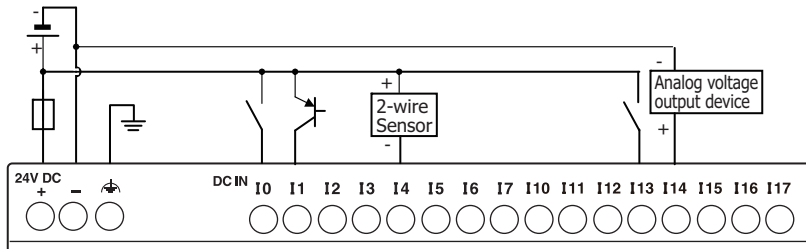

Output Side

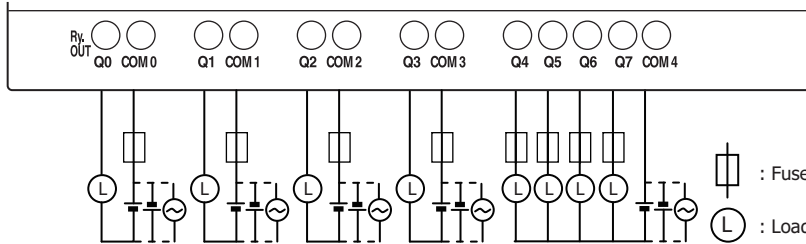

FT1A-H24RC, FT1A-B24RC

Terminal Arrangement and I/O Wiring Diagrams

Input Side

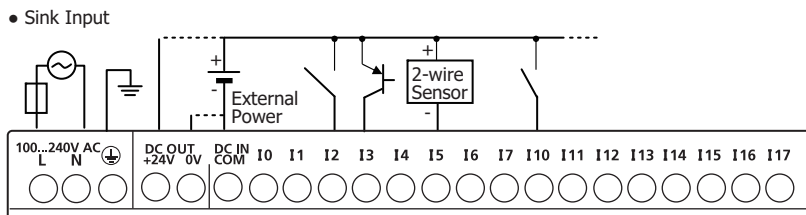
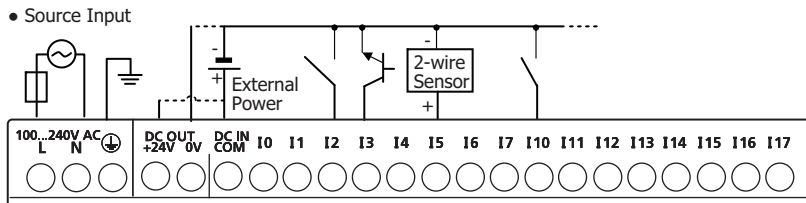

Output Side

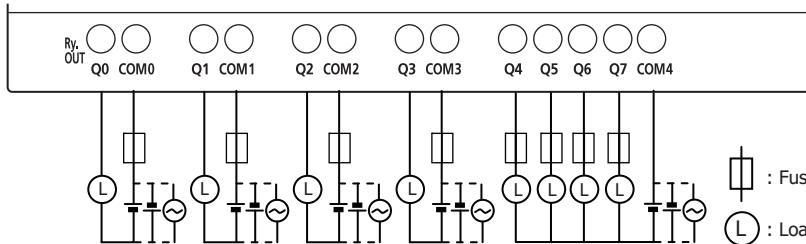

2: PRODUCT SPECIFICATIONS

FT1A-H40RSA, FT1A-B40RSA

Terminal Arrangement and I/O Wiring Diagrams

Input Side

- Sink Input

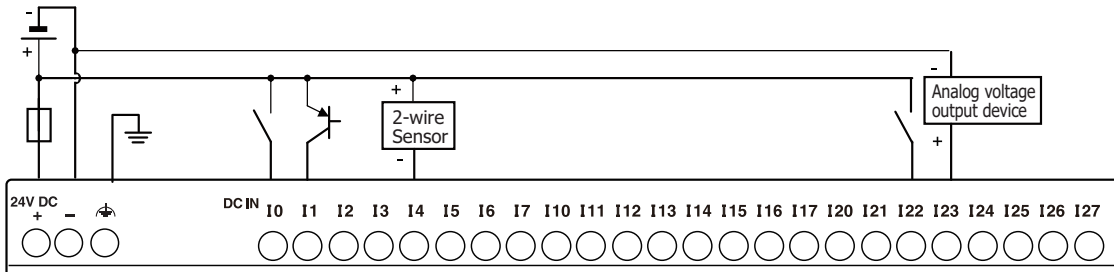

Output Side

- Source Output (Transistor Output)

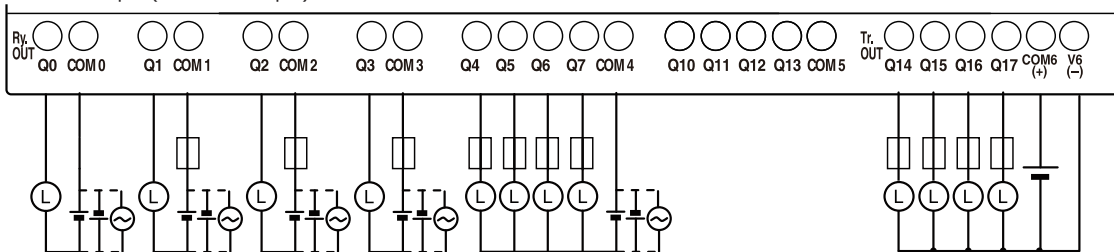

FT1A-H40RKA, FT1A-B40RKA

Terminal Arrangement and I/O Wiring Diagrams

Input Side

- Source Input (Analog/Digital Shared Input I22 is Sink Input)

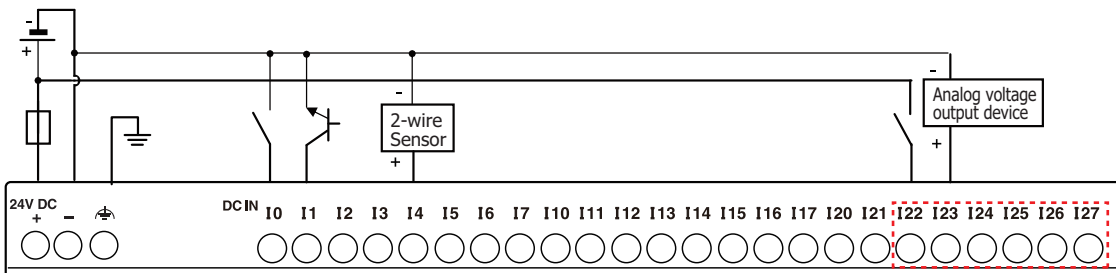

Output Side

- Sink Output (Transistor Output)

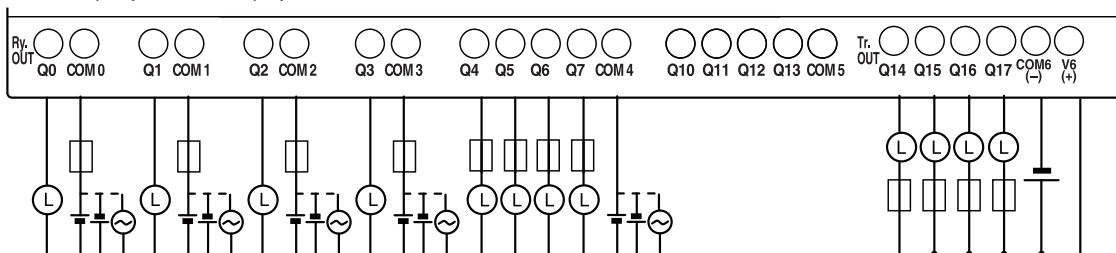

: Fuse : Load

FT1A-H40RC, FT1A-B40RC

Terminal Arrangement and I/O Wiring Diagrams

Input Side

- Source Input

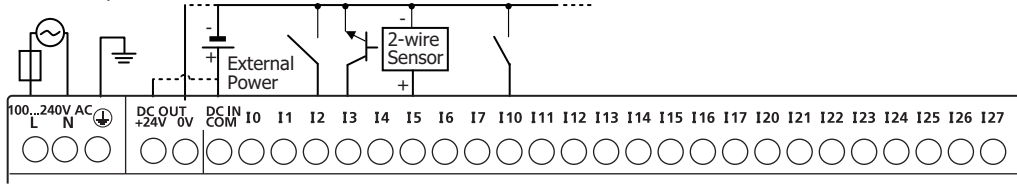

- Sink Input

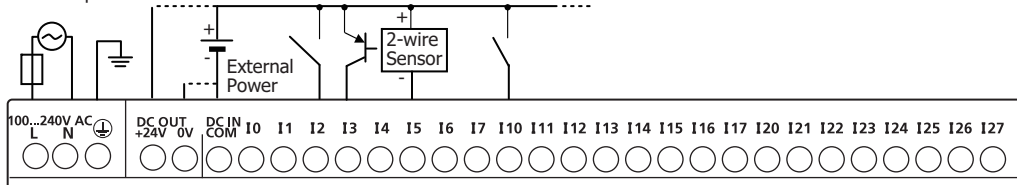

Output Side

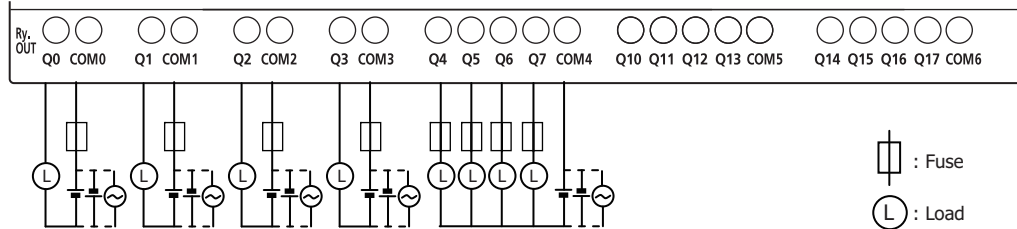

2: PRODUCT SPECIFICATIONS

FT1A-H48SA, FT1A-B48SA

Terminal Arrangement and I/O Wiring Diagrams

Input Side

- Sink Input

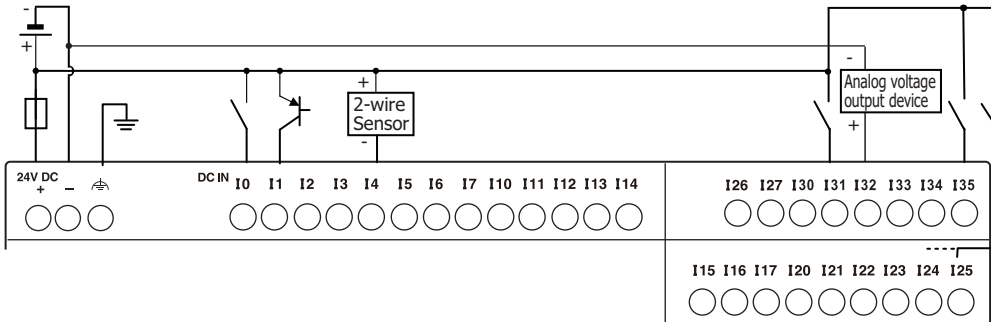

Output Side

- Source Output

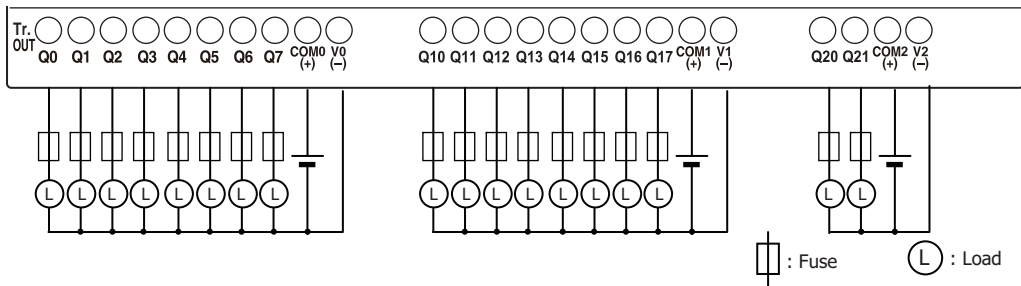

FT1A-H48KA, FT1A-B48KA

Terminal Arrangement and I/O Wiring Diagrams

Input Side

- Source Input (Analog/Digital Shared Input \square is Sink Input)

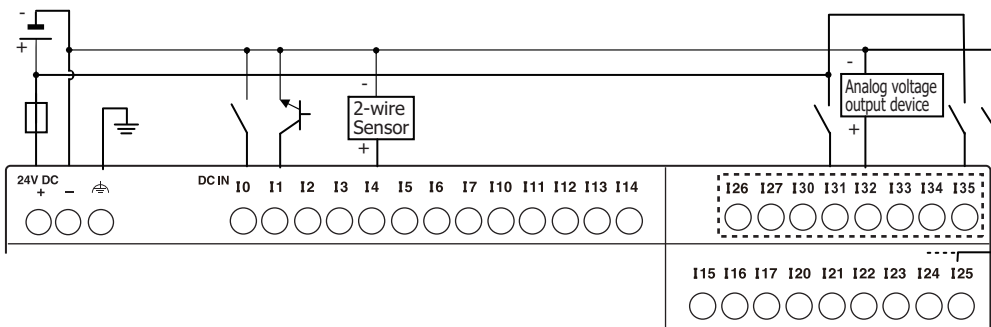

Output Side

- Sink Output

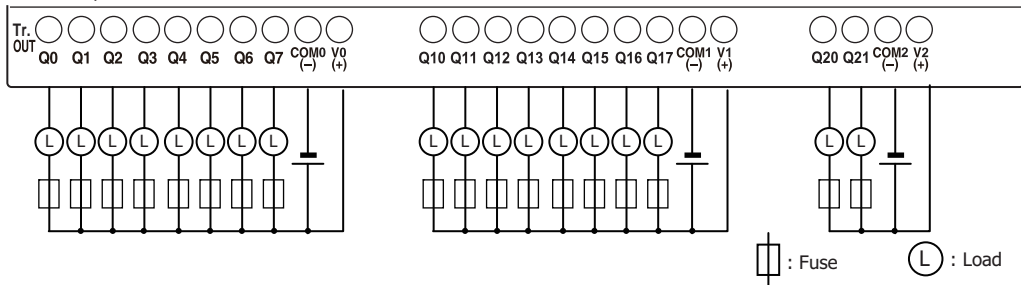

FT1A-B48SC, FT1A-H48SC

Terminal Arrangement and I/O Wiring Diagrams

Input Side

- Source Input

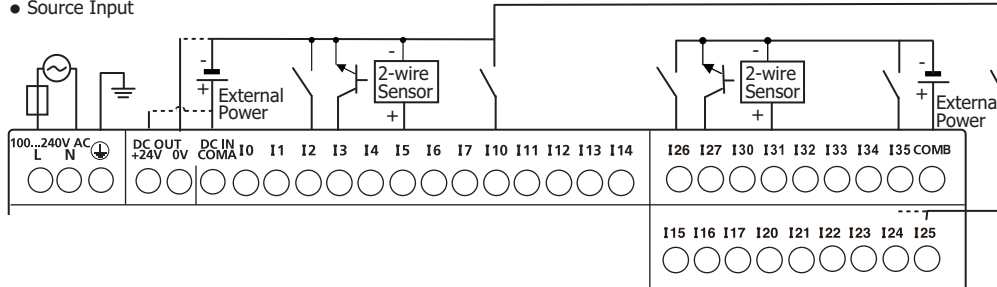

- Sink Input

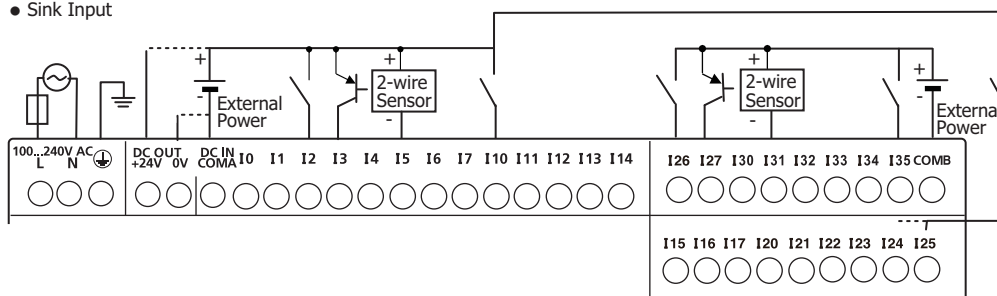

Output Side

- Source Output

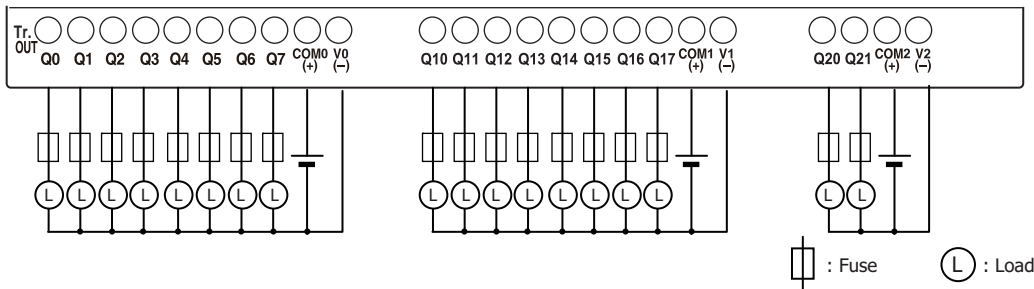

: Fuse : Load

2: PRODUCT SPECIFICATIONS

FT1A-H48KC, FT1A-B48KC

Terminal Arrangement and I/O Wiring Diagrams

Input Side

● Source Input

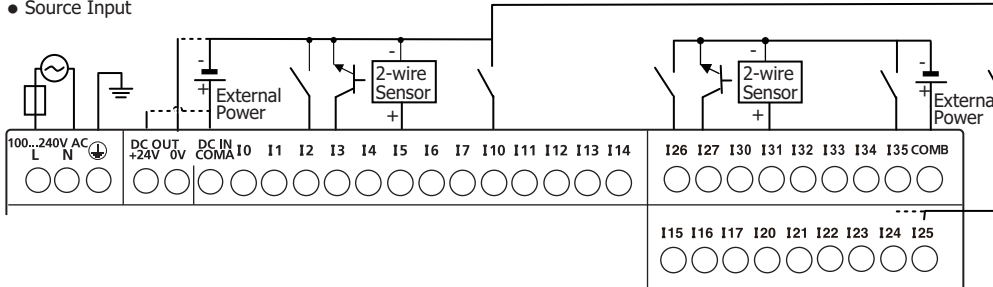

● Sink Input

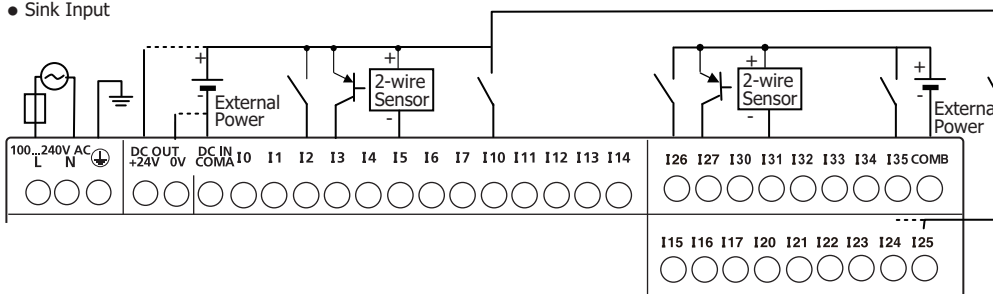

Output Side

● Sink Output

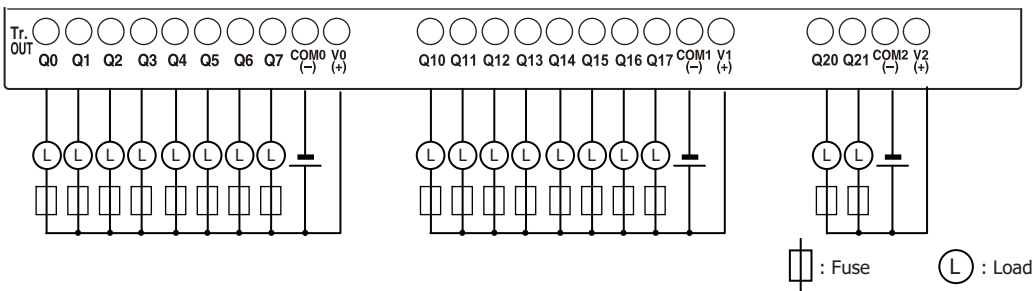

Communication Cartridge

Functions

By installing a communication cartridge on the SmartAXIS expansion communication port, the SmartAXIS can communicate with communication devices supporting RS232C/RS485, such as Modbus RTU compliant devices, barcode readers, or operator interfaces.

Specifications

Type No.	Item	Specifications
FT1A-PC1	Termination Connector	Mini DIN
	Standards	EIA RS232C
	Maximum Baud Rate	115,200 bps
	Communication Functions	Maintenance communication, User communication, Modbus RTU master/slave
	Isolation between Internal Circuit and Communication Port	Not isolated
	Recommended Communication Cable	Special cable
FT1A-PC2	Termination Connector	Mini DIN
	Standards	EIA RS485
	Maximum Baud Rate	115,200bps
	Communication Functions	Maintenance communication, User communication, Modbus RTU master/slave
	Isolation between Internal Circuit and Communication Port	Not isolated
	Recommended Communication Cable	Special cable
FT1A-PC3	Termination Connector	Screw Terminal block
	Standards	EIA RS485
	Maximum Baud Rate	115,200 bps
	Communication Functions	Maintenance communication, User communication, Modbus RTU master/slave
	Isolation between Internal Circuit and Communication Port	Not isolated
	Recommended Communication Cable	Twisted-pair shielded cable with a minimum core wire of 0.3 mm ² (Conductor resistance 85 Ω/km maximum, shield resistance 20 Ω/km maximum)
	Maximum Cable Length	200m

Note: For details on recommended communication cables, see "Cables" on page A-8.

Installation Procedure

Remove the expansion communication port cover by inserting a flat head screwdriver into the slots at the top and bottom of the cover. Press in the tabs at either end of the cover and lift the cover directly upward.

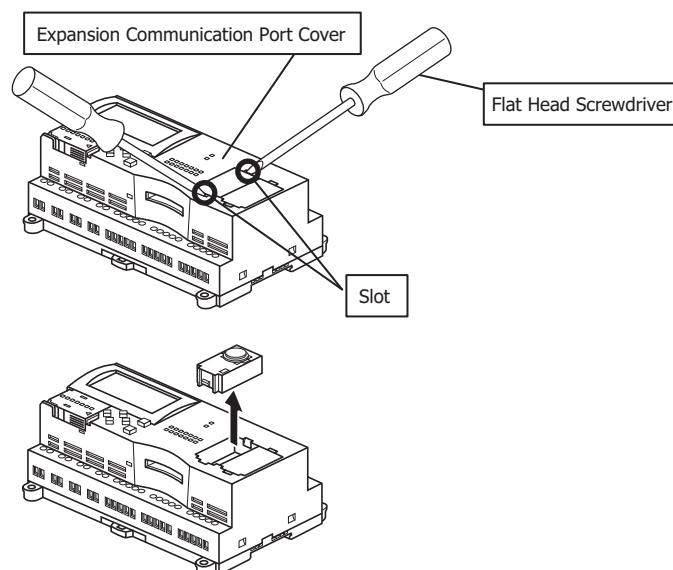

2: PRODUCT SPECIFICATIONS

After removing the expansion communication port cover, carefully install a communication cartridge on the SmartAXIS expansion communication port. Ensure that the cartridge is installed with the correct orientation.

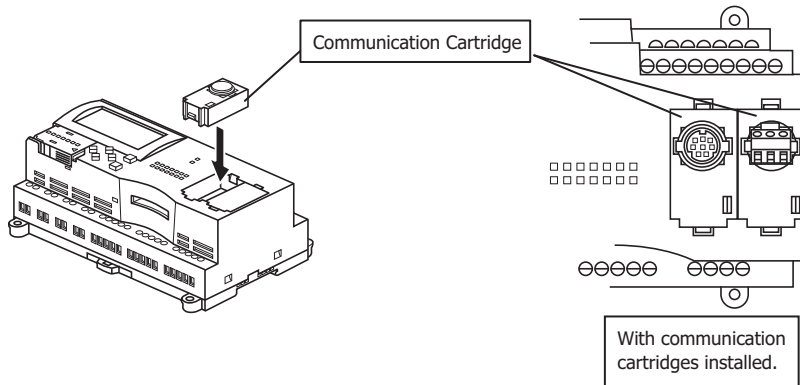

Removal Procedure

As in the procedure to remove the expansion communication port cover, insert a flat head screwdriver into the slots, press in the tabs at either end of the communication cartridge, and lift it directly upward. If the cartridge is removed in a crooked state, the housing of the cartridge or the internal connector may be damaged.

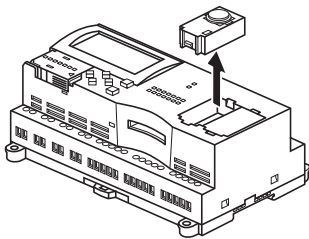

Caution

- Turn off the power to the SmartAXIS before removing or installing a communication cartridge.
- If a communication cartridge is installed while the SmartAXIS is powered, the SmartAXIS or the communication cartridge may be damaged.

Memory Cartridge

Functions

By installing a memory cartridge on which a user program is stored to the SmartAXIS, it is possible to change the user program executed by the SmartAXIS without using WindLDR. It is also possible to download a user program from a memory cartridge to the SmartAXIS. The user program stored in the SmartAXIS ROM can also be uploaded to a memory cartridge.

Memory Cartridge	User Program Execution Priority
Installed on the SmartAXIS	<ul style="list-style-type: none"> When a memory cartridge is installed on the SmartAXIS, the user program stored in the memory cartridge is executed. User programs can be downloaded from memory cartridges to the SmartAXIS using the memory cartridge download function or LCD operation (SmartAXIS Pro only). User programs can be uploaded to memory cartridges from the SmartAXIS ROM using the memory cartridge upload function or LCD operation (SmartAXIS Pro only). For details, see "Memory Cartridge" on page 5-49.
Not installed on the SmartAXIS	The user program stored in the SmartAXIS ROM is executed.

Note: Program capacity when using a memory cartridge is the same as the program capacity of the applicable SmartAXIS model. See "Function Specifications" on page 2-6.

Specifications

Item	Specifications
Type Number	FT1A-PM1
Memory Type	Flash ROM
Hardware for Storing Data	SmartAXIS
Quantity of Stored Programs	One user program per memory cartridge

User Program Compatibility

The SmartAXIS can execute only user programs created for the same PLC type. When installing a memory cartridge, make sure that the user program stored on the memory cartridge matches the PLC type. If the user program is not for the same PLC type, a user program syntax error occurs and the PLC cannot run the user program.

 **Caution** • **Compatibility of User Program with PLC System Software**

When a memory cartridge contains a user program for higher functionality, do not install the memory cartridge into PLCs with lower functionality, otherwise the user program syntax error occurs. Upgrade the system software of the PLCs so the PLCs can run the user program in the memory cartridge.

Installation Procedure

Insert a flat head screwdriver under the memory cartridge cover and pull the cover directly upward to remove it.

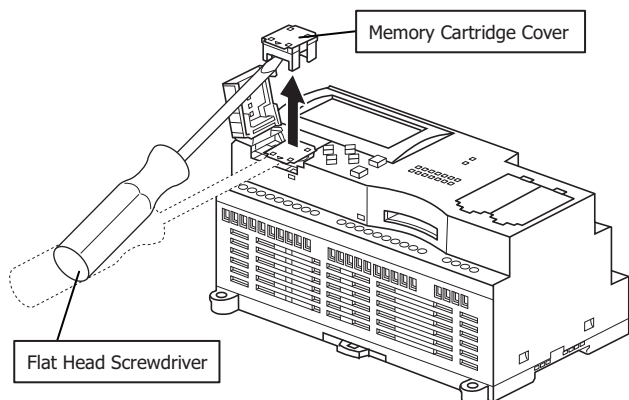

2: PRODUCT SPECIFICATIONS

After removing the memory cartridge cover, install a memory cartridge. Confirm that the triangular marks on the memory cartridge and on the SmartAXIS point at each other to ensure that the memory cartridge is installed with the correct orientation.

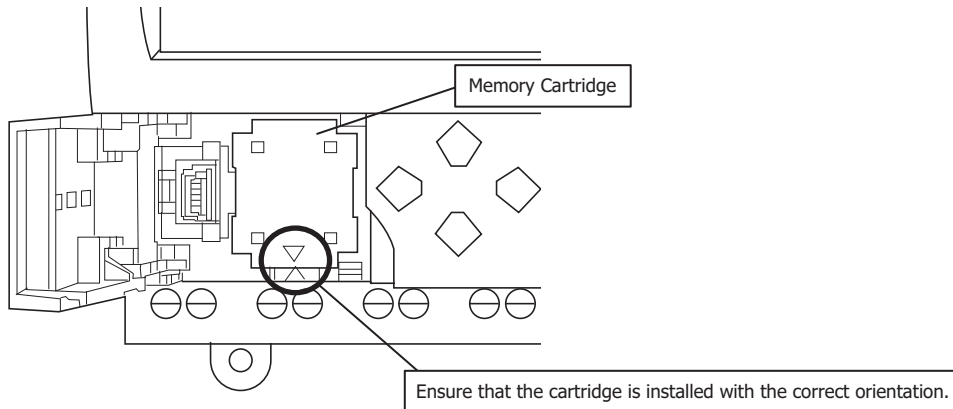

Removal Procedure

As in the procedure to remove the memory cartridge cover, insert a flat head screwdriver under the memory cartridge cover and pull the cover directly upward to remove it. If the cartridge is removed in a crooked state, the housing of the cartridge or the internal connector may be damaged.



Caution

- Turn off the power to the SmartAXIS before removing or installing a memory cartridge. If a memory cartridge is installed while the SmartAXIS is powered, the SmartAXIS or the memory cartridge may be damaged.
- Do not damage the SmartAXIS with the screwdriver.

Ethernet Port

Functions

SmartAXIS with Ethernet port can communicate with other network devices that support Ethernet communications, such as maintenance communication, Modbus TCP (client and server) communication, and user-defined communication (ETXD and ERXD commands).

Applicable Models

An Ethernet port is available on the 24-, 40-, and 48-I/O types.

12-I/O type	24-I/O type	40-I/O type	48-I/O type
No	Yes	Yes	Yes

Specifications

Item	Specifications
Transmission Speed	10BASE-T/100BASE-TX
Electrical Characteristics	IEEE 802.3-compliant
Recommended Cable	CAT.5 STP (Category 5 shielded twisted-pair cable)
Connector	RJ45
AutoMDI/MDI-X Function	Yes (when only two SmartAXIS are connected, they can be directly connected with a straight cable)

Installation Procedure

Remove the protective seal covering the Ethernet port and insert the connector of an Ethernet cable securely.

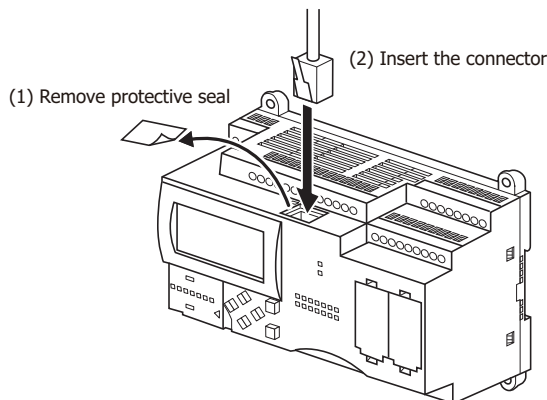

Caution

- Turn off the power to the SmartAXIS before connecting an Ethernet cable to the Ethernet port.
- If an Ethernet cable is connected while the SmartAXIS is powered, electrical shock to the operator or damage to the SmartAXIS may be caused.

2: PRODUCT SPECIFICATIONS

SD Memory Card

Applicable Models

SD memory cards can be used only with the 40- and 48-I/O types.

12-I/O type	24-I/O type	40-I/O type	48-I/O type
No	No	Yes	Yes

SD Memory Card Usage

Specified device values can be saved in CSV files on an SD memory card using the DLOG and TRACE instructions/FB. This makes it possible to save log data or analyze the data when an error occurs.

CSV files saved on an SD memory card can be read out to a computer using WindLDR.

For details on the DLOG and TRACE instructions, see Chapter 26 "Data Log Instructions" in the "SmartAXIS Ladder Programming Manual". For details on the DLOG and TRACE FB, see Chapter 16 "The data logging FB" in the "SmartAXIS FBD Programming Manual".

Specifications

Item	Specifications	
Supported SD Memory Cards	SD memory cards (2GB maximum), SDHC memory cards (32GB maximum)	
File System	FAT16/FAT32 SD memory cards of 2GB or less are only supported in FAT16 format. SD memory cards of 2GB formatted in FAT32 are not recognized.	
File Specifications	Format	CSV
	Size	5MB maximum
	Supported Characters	Single-byte alphanumeric characters The following characters cannot be used in drive names: \" & () * + , . / : ; < > [] = ^ The following characters cannot be used in file and folder names: \\ / : * ? " < >
Maximum Number of Files	Dependant on file system: • FAT16 65,534 maximum per sub-directory • FAT32 65,534 maximum per sub-directory	

Recommended SD Memory Card

Recommended SD Memory Card	SDHC memory cards (32GB maximum)
-----------------------------------	----------------------------------

Notes:

- It is recommended that SDHC memory cards are formatted on the SmartAXIS before it is used.
- It is recommended that important data is regularly backed up on separate media such as CDs or DVDs.

Installation

Follow the indications on the SmartAXIS and insert an SD memory card into the SD memory card slot on the SmartAXIS until you hear a click.

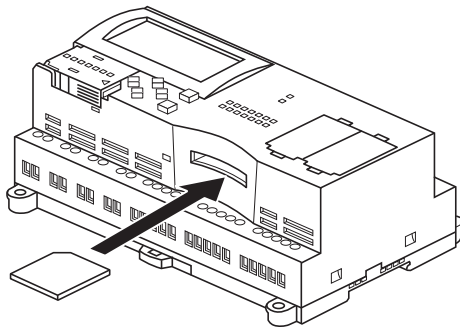

Removal

Press the SD memory card in the SD memory card slot on the SmartAXIS until you hear a click and move your finger back.

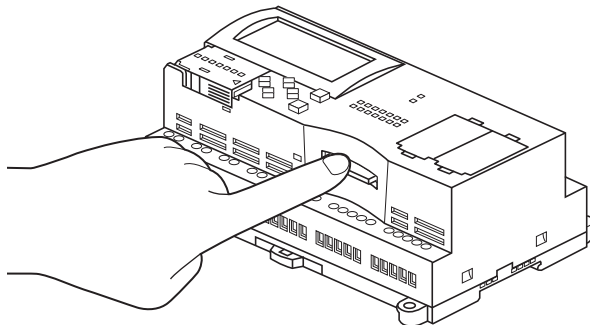

The SD memory card will come partially out of the slot. Use your fingers to remove the SD memory card completely.

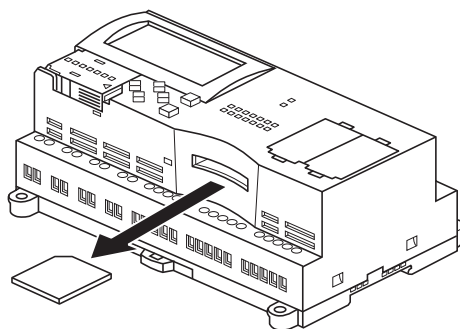

Notes:

- Insert and remove the SD memory card in the direction indicated on the SmartAXIS.
- Set the write-protect switch of the SD memory card to the OFF position before inserting into the SmartAXIS.



Caution

If any of the actions below are performed while the SD memory card is being accessed, data on the card may be damaged:

- The SmartAXIS is turned off.
- The SD memory card is removed.

Do not turn off the SmartAXIS while the SD memory card is being accessed (while the SD memory card status LED is flashing). Confirm that the SD memory card status LED is not flashing before removing the card from the SmartAXIS. For details on SD memory card status LED, see "SD Memory Card Maintenance with WindLDR" on page 5-53.

2: PRODUCT SPECIFICATIONS

Dimensions

FT1A-H12RA

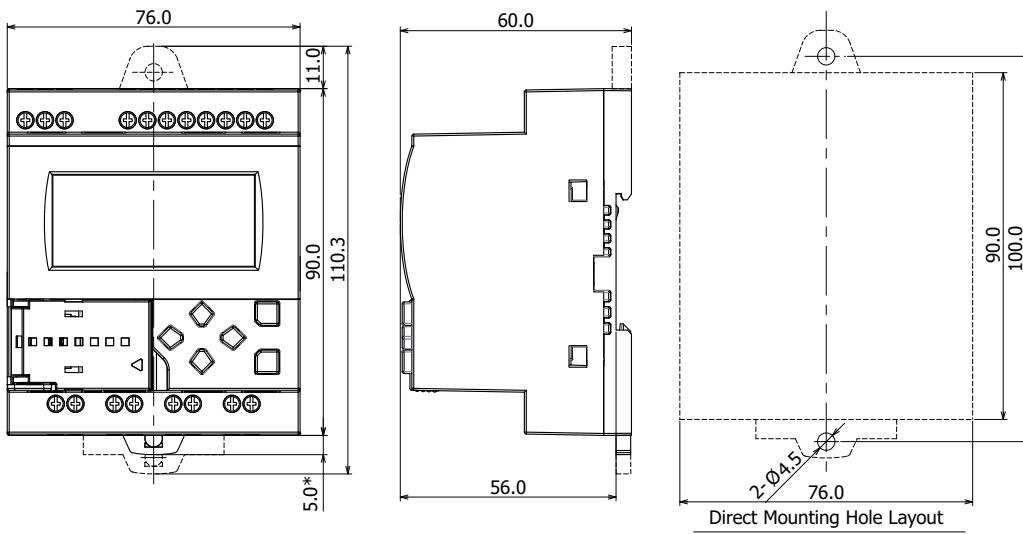

*9.3mm when the clamp is pulled out.

FT1A-B12RA

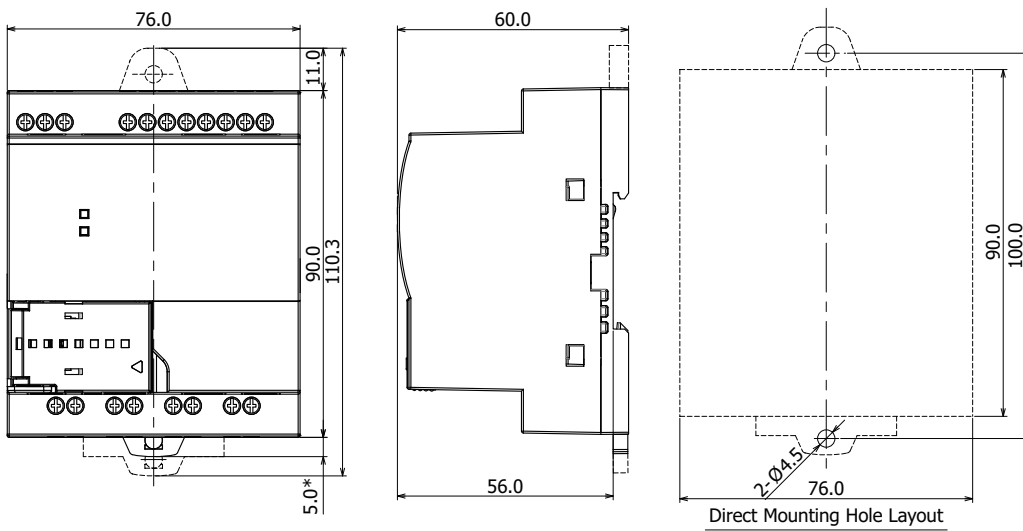

*9.3mm when the clamp is pulled out.

FT1A-H12RC

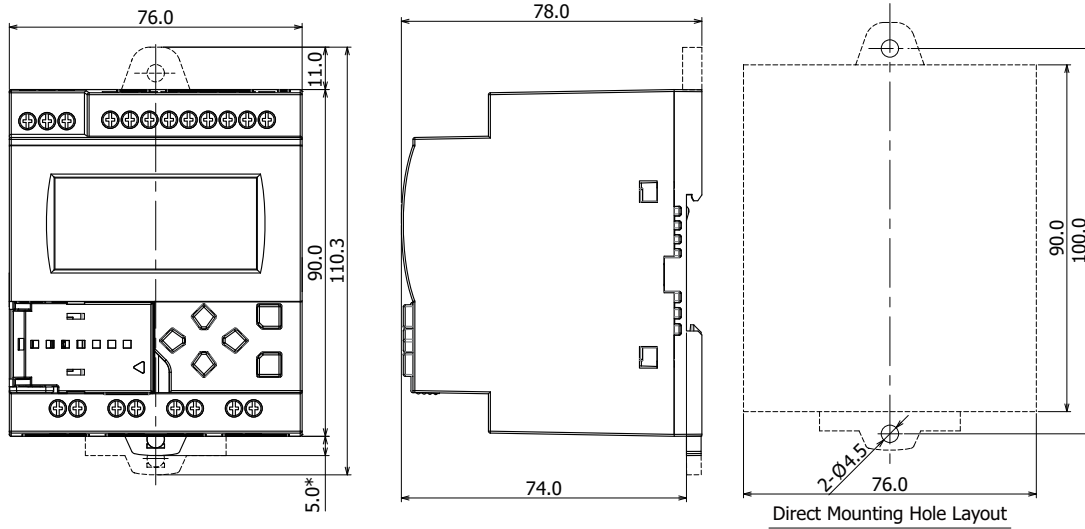

*9.3mm when the clamp is pulled out.

FT1A-B12RC

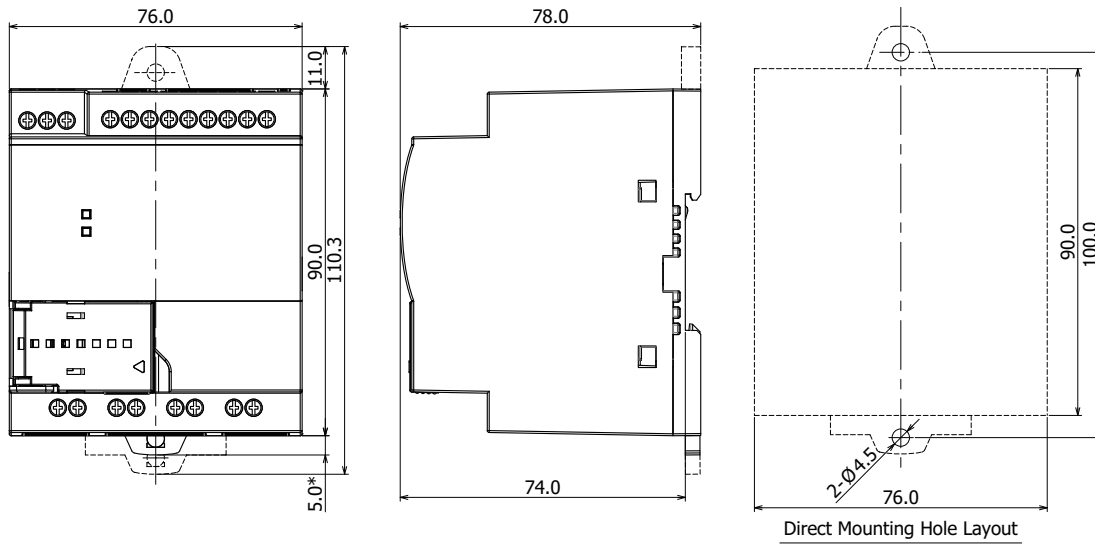

*9.3mm when the clamp is pulled out.

FT1A-H24RA

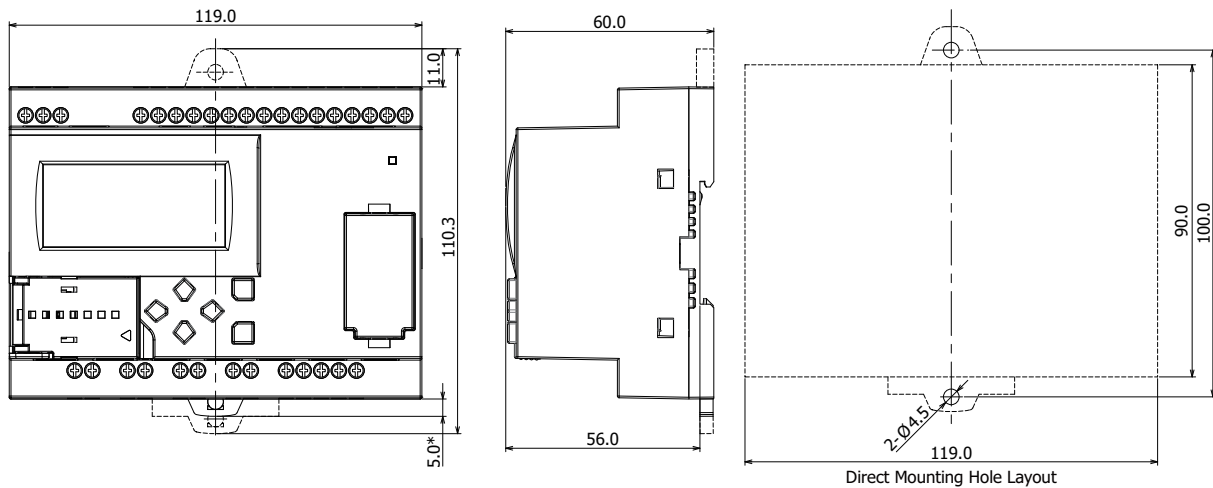

*9.3mm when the clamp is pulled out.

2: PRODUCT SPECIFICATIONS

FT1A-B24RA

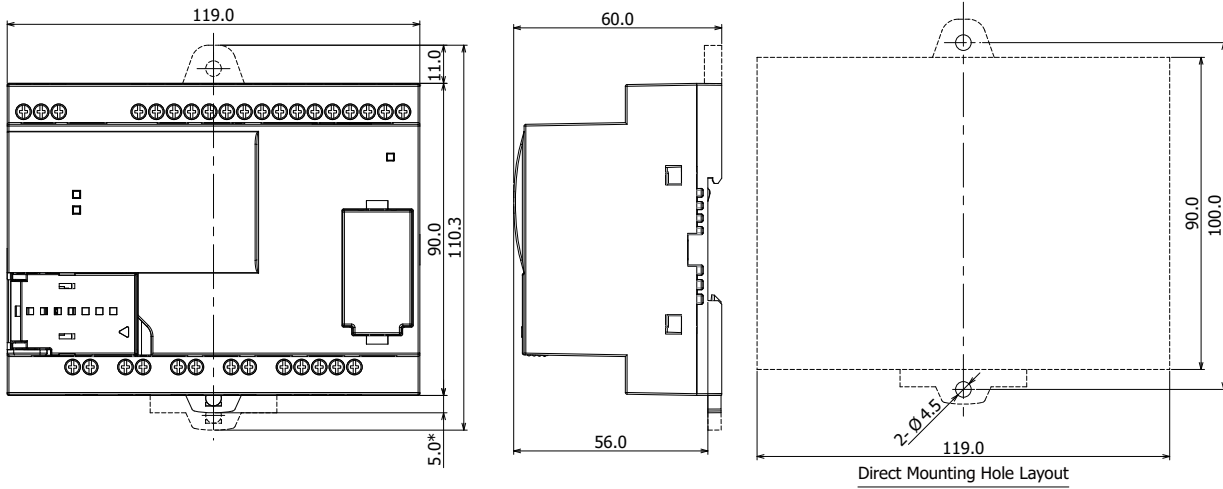

*9.3mm when the clamp is pulled out.

FT1A-H24RC

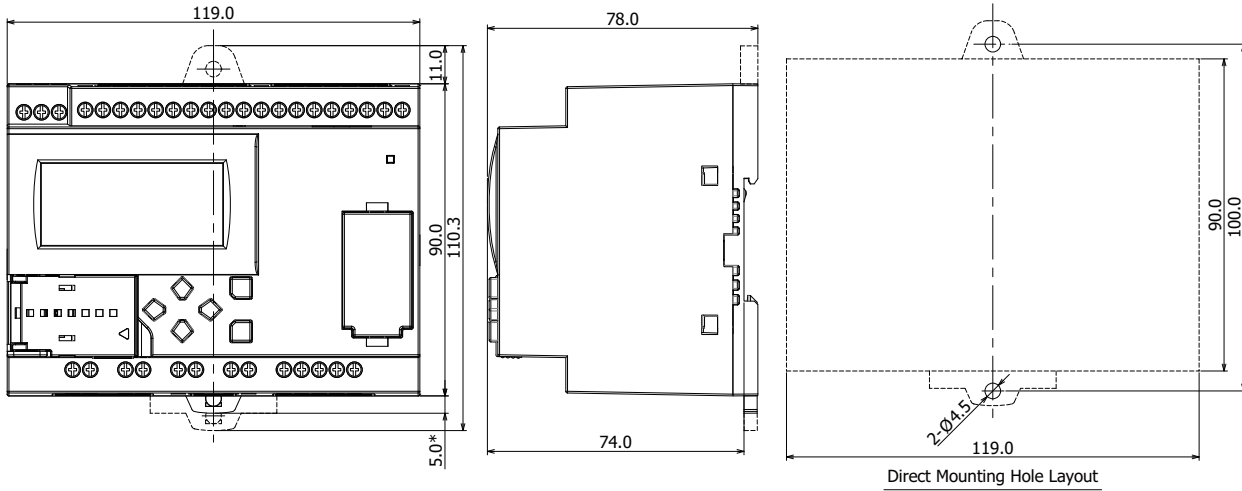

*9.3mm when the clamp is pulled out.

FT1A-B24RC

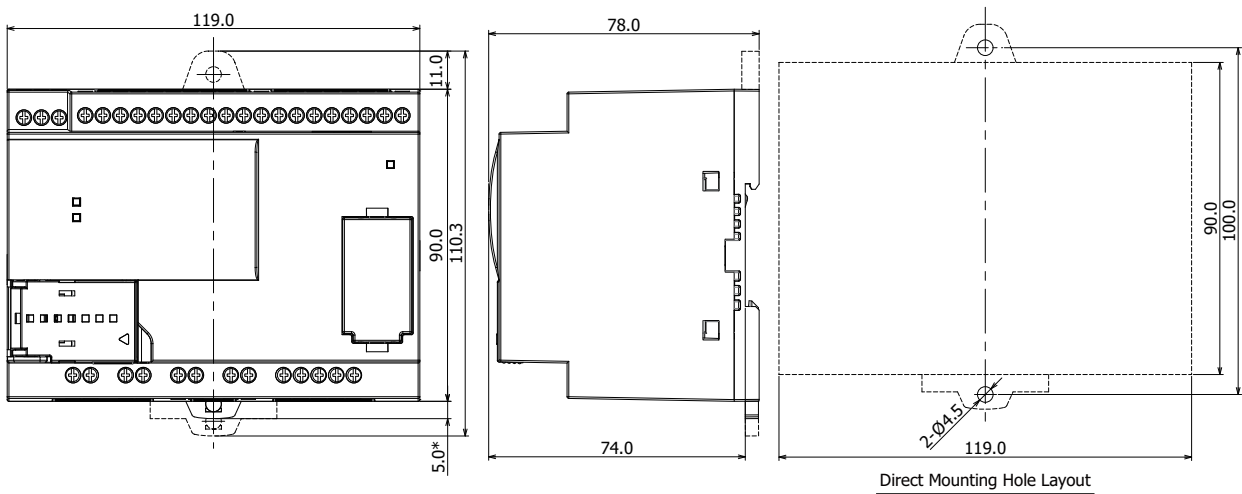

*9.3mm when the clamp is pulled out.

FT1A-H40RSA, FT1A-H40RKA

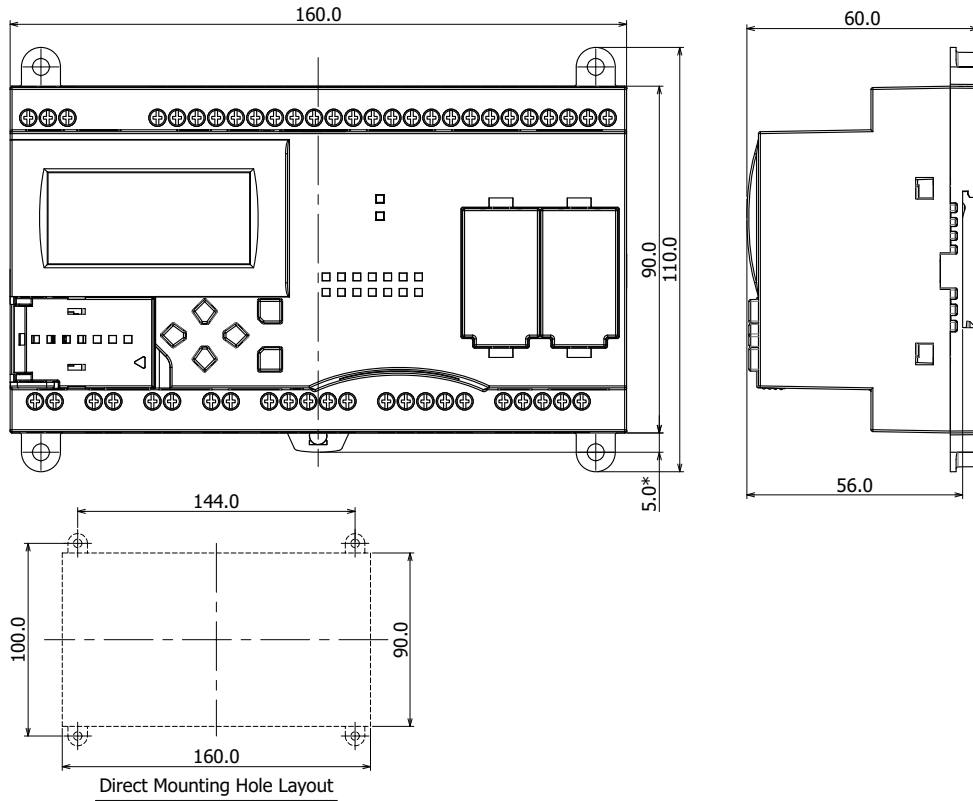

*9.3mm when the clamp is pulled out.

FT1A-B40RSA, FT1A-B40RKA

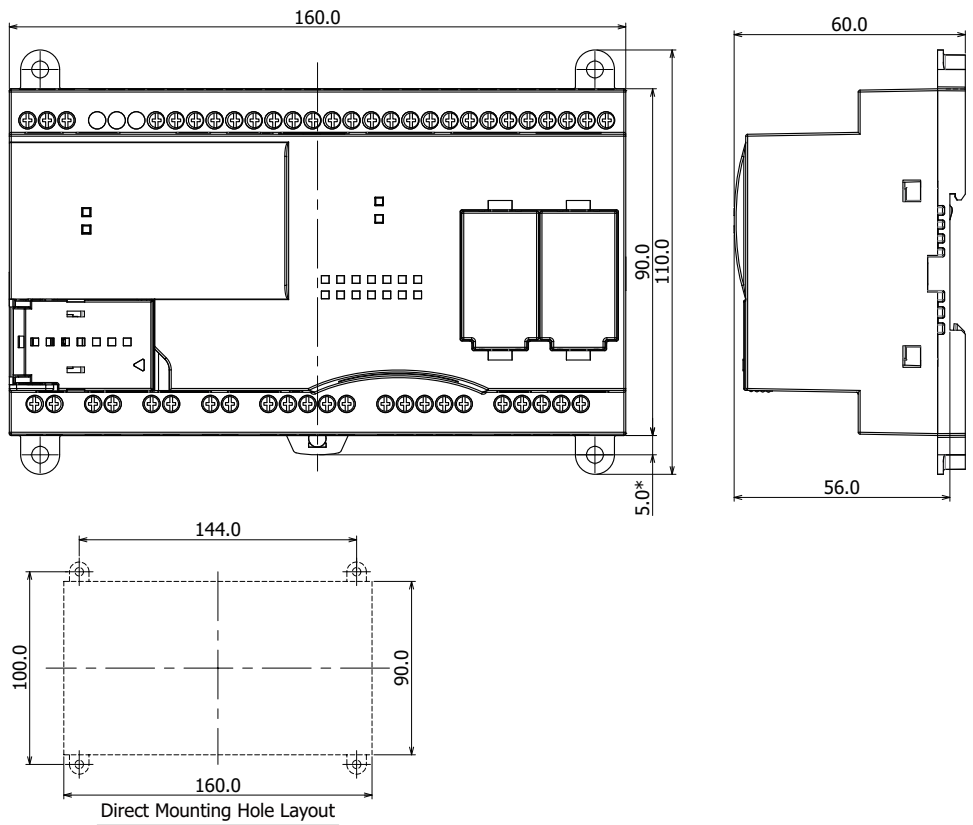

*9.3mm when the clamp is pulled out.

2: PRODUCT SPECIFICATIONS

FT1A-H40RC

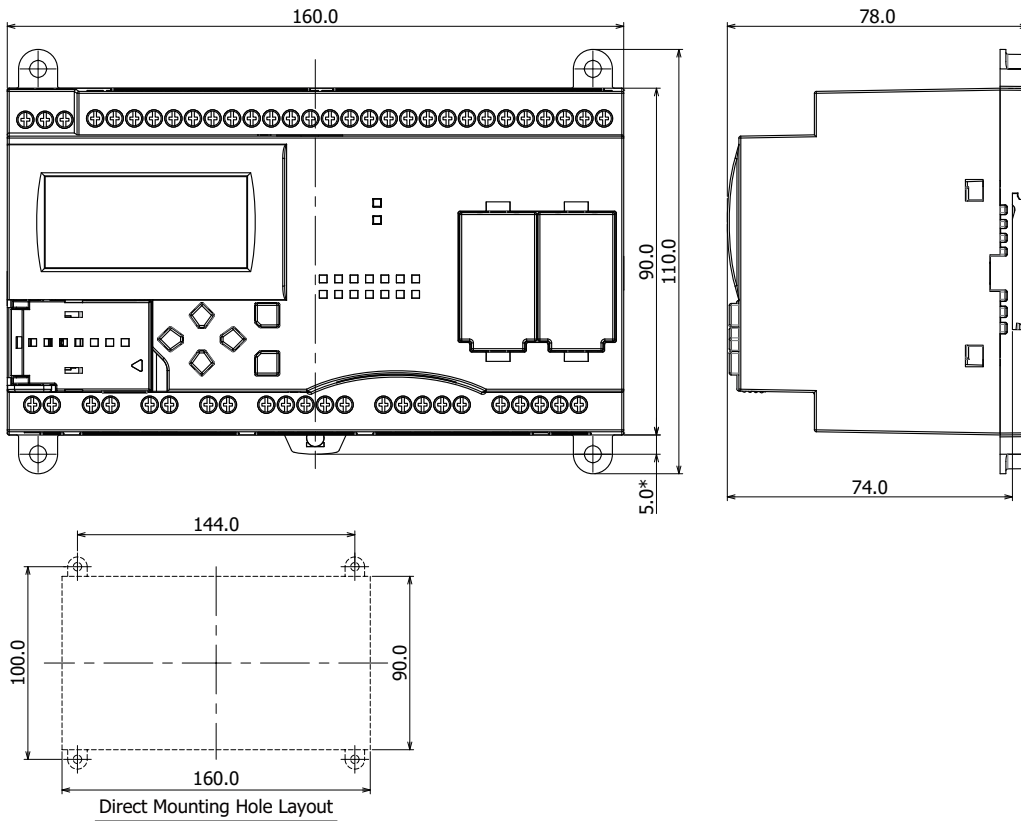

*9.3mm when the clamp is pulled out.

FT1A-B40RC

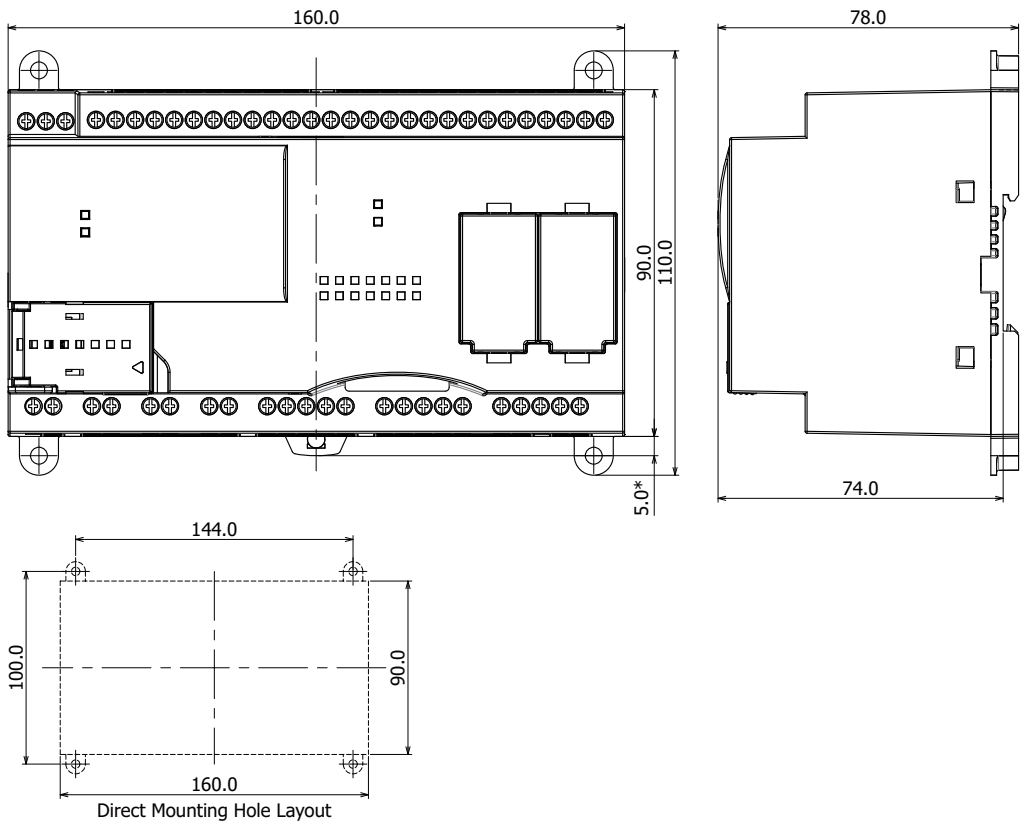

*9.3mm when the clamp is pulled out.

FT1A-H48SA, FT1A-H48KA

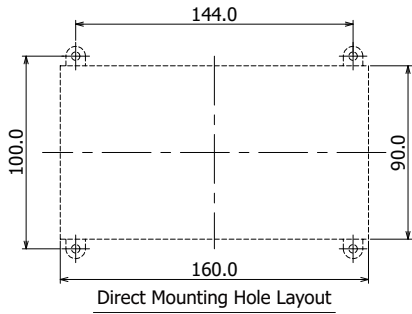
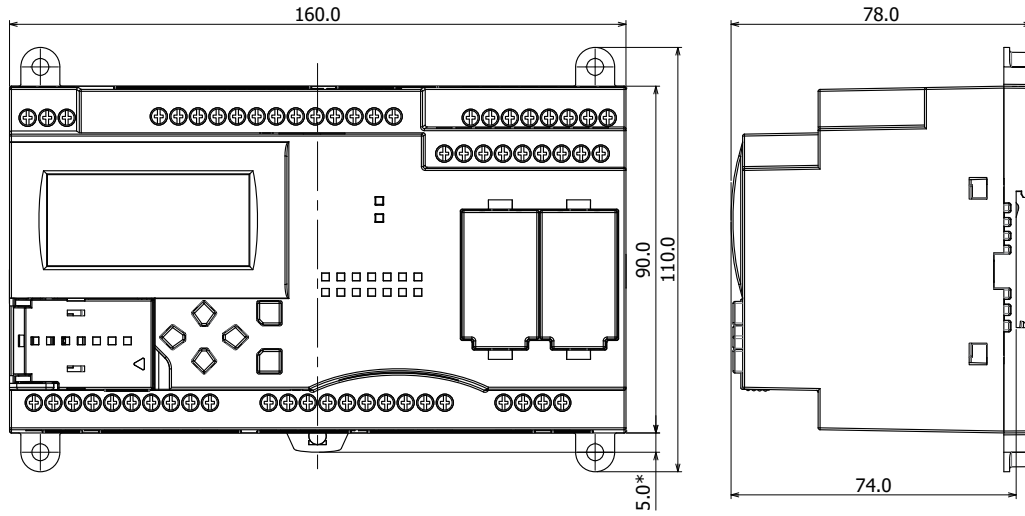

*9.3mm when the clamp is pulled out.

FT1A-B48SA, FT1A-B48KA

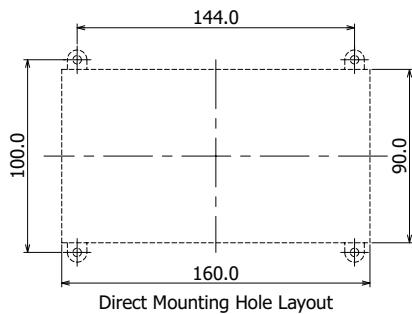
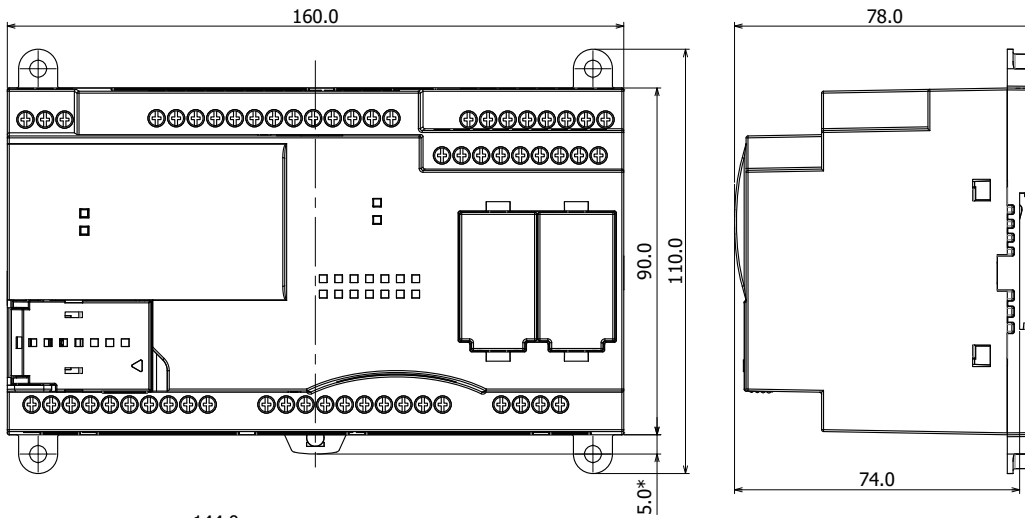

*9.3mm when the clamp is pulled out.

2: PRODUCT SPECIFICATIONS

FT1A-H48SC, FT1A-H48KC

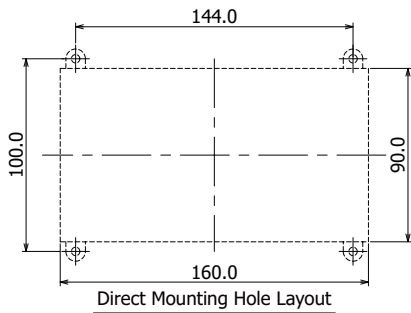
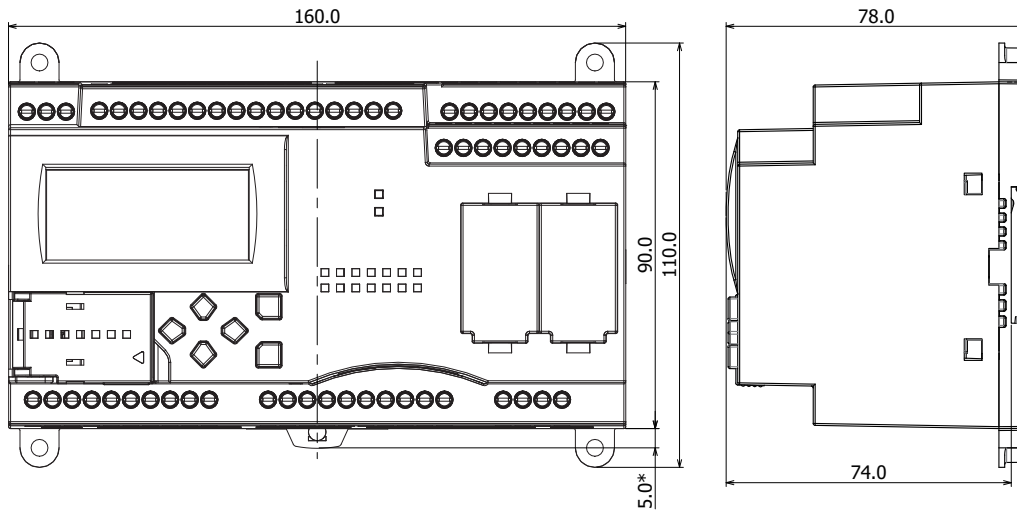

*9.3mm when the clamp is pulled out.

FT1A-B48SC, FT1A-B48KC

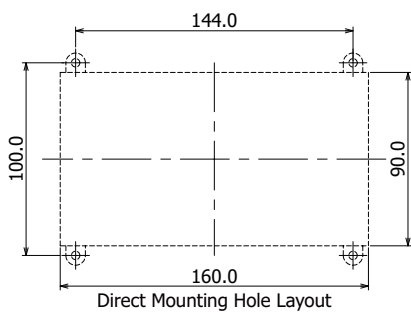
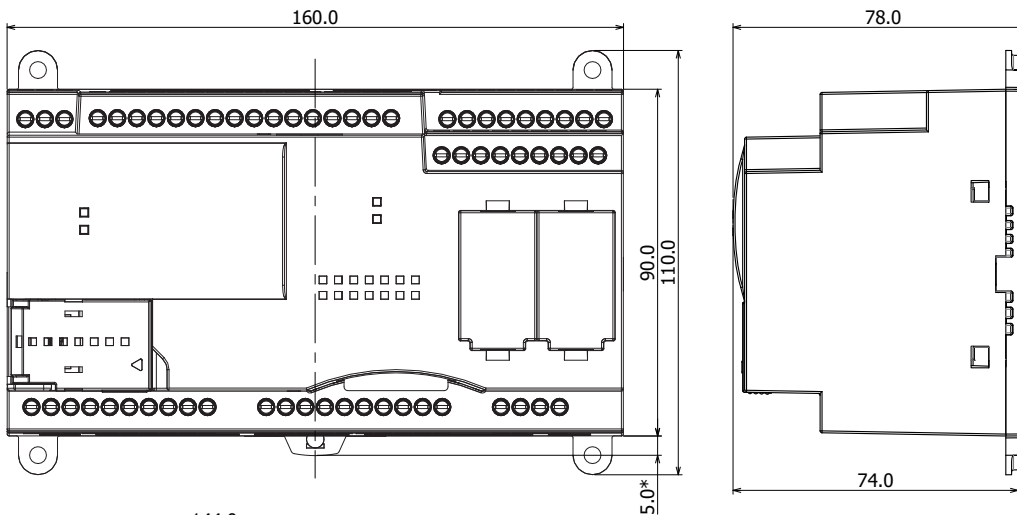

*9.3mm when the clamp is pulled out.

3: INSTALLATION AND WIRING

Introduction

This chapter describes the methods and precautions for installing and wiring SmartAXIS modules.

Before starting installation and wiring, be sure to read "Safety Precautions" in the beginning of this manual and understand precautions described under Warning and Caution.



Warning

- Turn off the power to the SmartAXIS before starting installation, removal, wiring, maintenance, and inspection of the SmartAXIS. Failure to turn power off may cause electrical shocks or fire hazard.
- Emergency stop and interlocking circuits must be configured outside the SmartAXIS. If such a circuit is configured inside the SmartAXIS, failure of the SmartAXIS may cause disorder of the control system, damage, or accidents.
- Special expertise is required to install, wire, program, and operate the SmartAXIS. People without such expertise must not use the SmartAXIS.



Caution

- Prevent metal fragments and pieces of wire from dropping inside the SmartAXIS housing. Put a cover on the SmartAXIS modules during installation and wiring. Ingress of such fragments and chips may cause fire hazard, damage, or malfunction.
- Do not touch the connector pins with your hand. Electrostatic discharge may damage the internal elements.
- When handling the SmartAXIS, take measures to discharge static electricity.
- Keep the SmartAXIS wiring away from motor lines.

Installation Location

The SmartAXIS is designed to be installed in control panels and similar locations.

Install the SmartAXIS within product specifications.

Avoid use in the environments below, as doing so may cause electric shock, fire, or malfunction:

Places where there is a lot of dust, salt, iron powder, or soot.

Places exposed to direct sunlight.

Places where the SmartAXIS may be exposed to vibration or shock, either directly or indirectly.

Atmospheres of corrosive or flammable gases.

Places where condensation may form.

Places where the SmartAXIS may be directly exposed to water.

Around high-voltage lines, high-voltage equipment, motor lines, or motor equipment.

Places near where a large switching surge may occur.

Places subject to a strong magnetic or electrical field.

Always mount the SmartAXIS vertically as shown below. To provide ample ventilation, ensure that there is sufficient space between the SmartAXIS and other devices, heat sources, and panel surfaces.

SmartAXIS Pro

SmartAXIS Lite

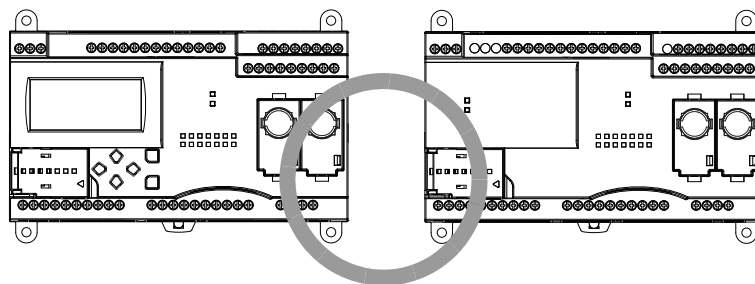

3: INSTALLATION AND WIRING

The SmartAXIS can be mounted face up when the ambient temperature is 35°C or lower, and can be mounted on its side when the ambient operating temperature is 40°C or lower. Do not mount the SmartAXIS on its side when the ambient temperature will exceed 40°C.

Side Orientation (Use if 40°C or less)

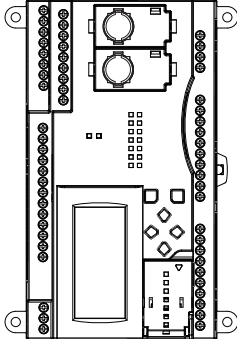

Face Up Orientation (Use if 35°C or less)

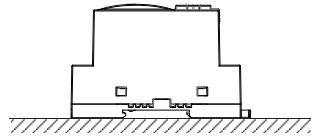

Do not install the SmartAXIS face down.

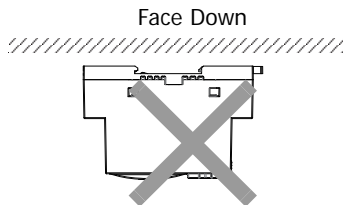

Mounting Space

To allow for heat dissipation and facilitate replacement, ensure that there are at least 20 to 40mm between the SmartAXIS and surrounding equipment and ducts.

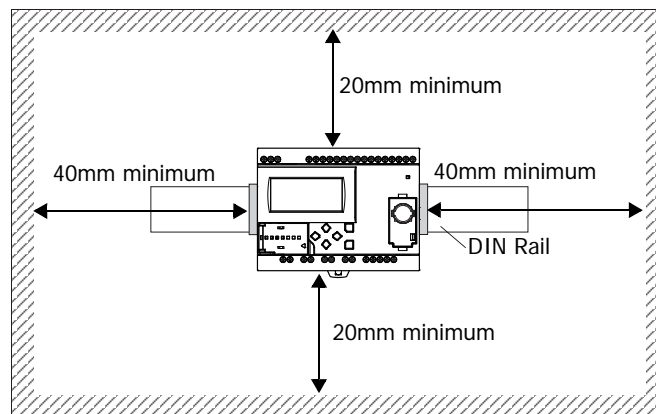

Mounting Two or More Units

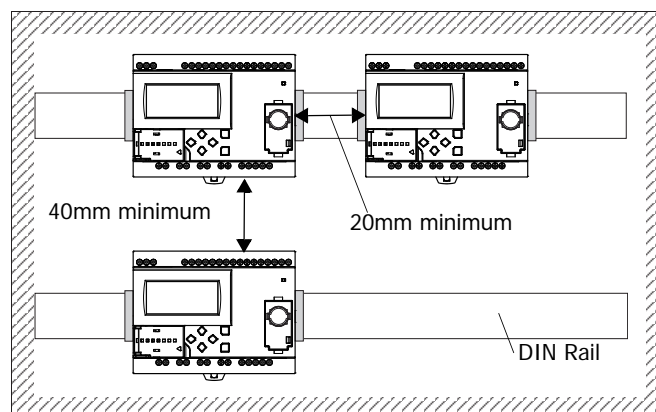

Mounting on DIN Rail



Caution

- Install the SmartAXIS modules according to instructions described in this user’s manual. Improper installation will result in falling, failure, or malfunction of the SmartAXIS.
- Do not install the SmartAXIS when it is powered up. Doing so may result in electric shock and may damage the product.

This section describes how to mount the SmartAXIS.

The SmartAXIS can be mounted directly on a DIN rail or in a control panel.

1. Firmly fasten the DIN rail to a panel using screws.
2. Using a flat head screwdriver, lower the DIN rail clamp and hang the SmartAXIS on the DIN rail.

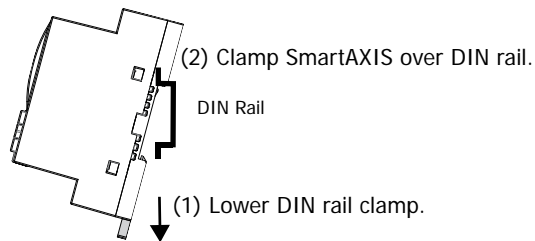

3. Align the SmartAXIS with the DIN rail and raise the DIN rail clamp.

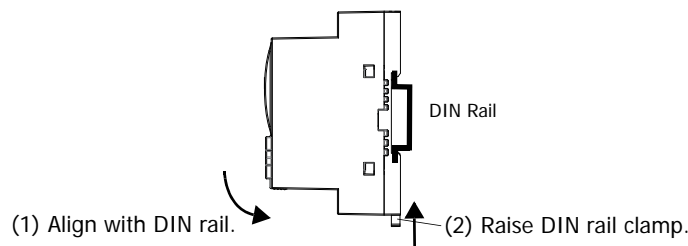

4. Secure both ends of the SmartAXIS using the DIN rail brackets.

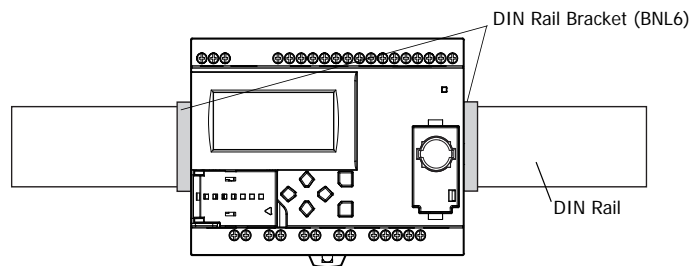

Removing from DIN Rail

1. Using a flat head screwdriver, lower the DIN rail clamp on the SmartAXIS.
2. Pull the SmartAXIS outward and upward at the same time.

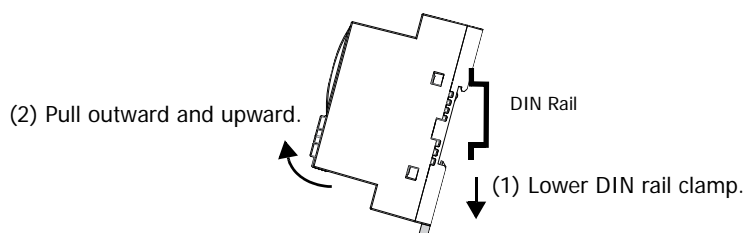

Note: The SmartAXIS supports 35mm wide DIN rails. Supported rails: IDEC BAA1000 (Length: 1000mm)

Direct Mounting on Panel Surface

This section describes how to mount the SmartAXIS directly onto a mounting plate for installation in a control panel. The 12- and 24-I/O types are mounted differently from the 40- and 48-I/O types. To mount the SmartAXIS directly, it may be necessary to make holes in the mounting plate depending on the SmartAXIS model.

Preparations

When directly mounting the 12- and 24-I/O types, pull out the direct-mounting plate and the DIN rail clamp on the back of the SmartAXIS, and attach the SmartAXIS to the mounting plate using the screw holes. Attach the 40- and 48-I/O types to the mounting plate using the screw holes on the back of the SmartAXIS.

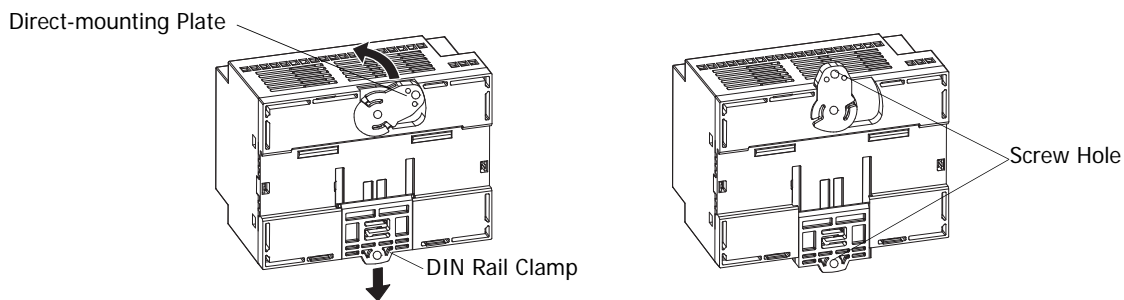

Mounting Hole Layout for Direct Mounting on Panel Surface

Attach the SmartAXIS to the mounting plate using M4 tapping screws, as shown below, or make 5 to 6mm mounting holes and secure the SmartAXIS using M4 pan head screws.

Always give sufficient consideration to operability, ease-of-maintenance, and environmental resistance when deciding on the mounting position.

- **12-I/O type (FT1A-H12RA, FT1A-B12RA, FT1A-H12RC, FT1A-B12RC)**

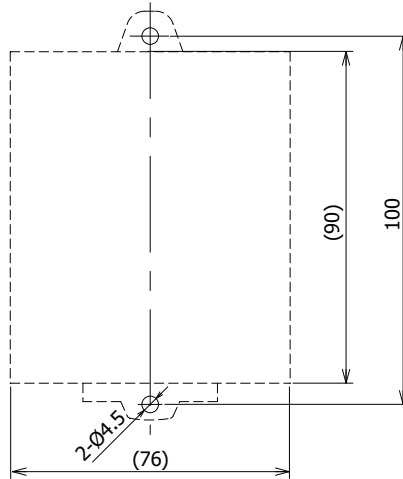

All dimensions in mm.

- **24-I/O type (FT1A-H24RA, FT1A-B24RA, FT1A-H24RC, FT1A-B24RC)**

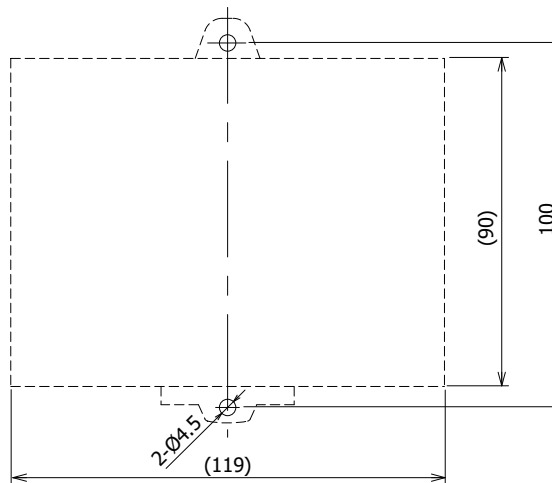

All dimensions in mm.

3: INSTALLATION AND WIRING

- 40-I/O type (FT1A-H40RKA, FT1A-H40RSA, FT1A-B40RKA, FT1A-B40RSA, FT1A-H40RC, FT1A-B40RC)

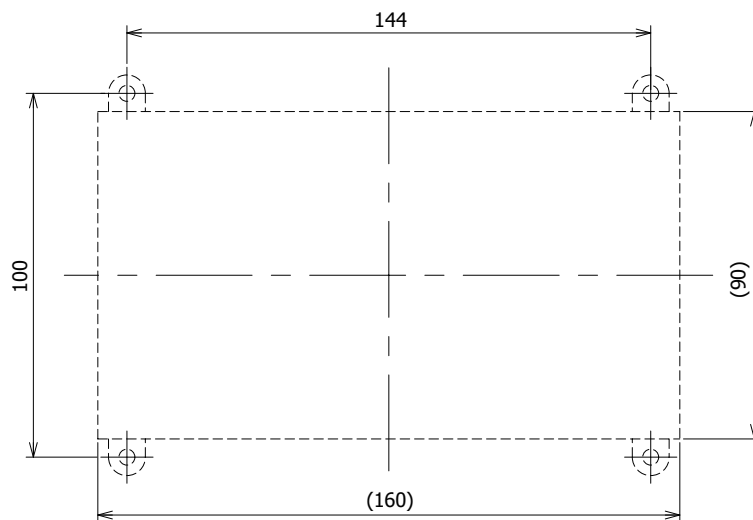

All dimensions in mm.

- 48-I/O type (FT1A-H48KA, FT1A-H48SA, FT1A-B48KA, FT1A-B48SA, FT1A-H48KC, FT1A-H48SC, FT1A-B48KC, FT1A-B48SC)

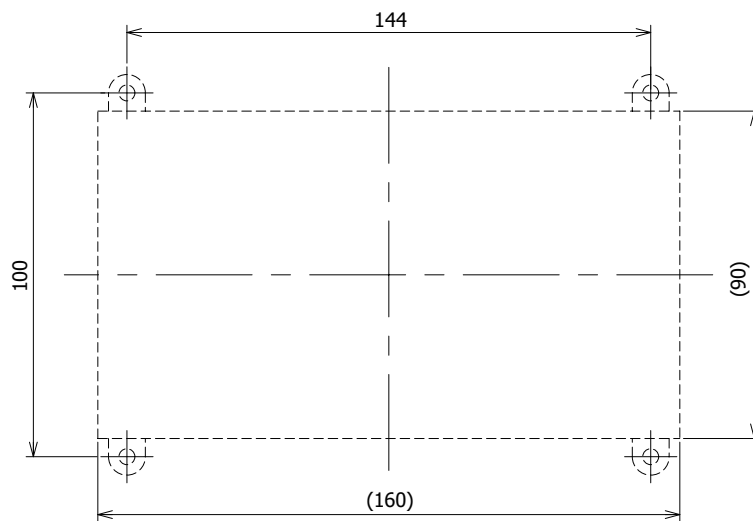

All dimensions in mm.



Caution

- When directly mounting the SmartAXIS, tighten mounting screws with torque of 1N·m (10kgf·cm).

Input/Output Wiring

This section describes SmartAXIS input/output device wiring.

Precautions for I/O Device Wiring

Input Terminal Wiring

When wiring input devices, separate wiring from power, output, and motor lines.

When using duct for wiring, ground piping using a D-type (type 3) ground.

When wiring DC power type models, keep wiring away from AC power lines.

When using shielded cable for wiring, ground the shield on the SmartAXIS side using a D-type (type 3) ground.

Wire input devices you want to connect to the SmartAXIS according to type as shown below.

DC Power Type

Digital Input – Sink Input

- Contact Output

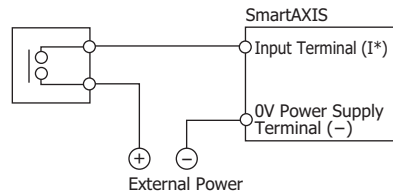

- PNP Output

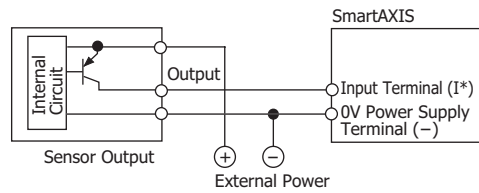

Digital Input – Source Input

- Contact Output

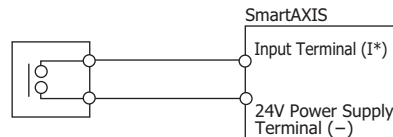

- NPN Output

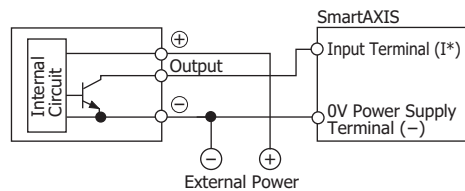

- 2-wire Sensor

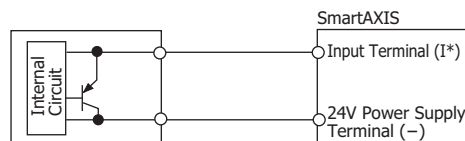

3: INSTALLATION AND WIRING

Shared Analog Input

- Contact Output

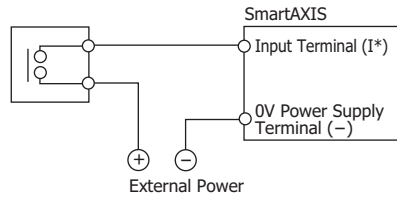

- PNP Output

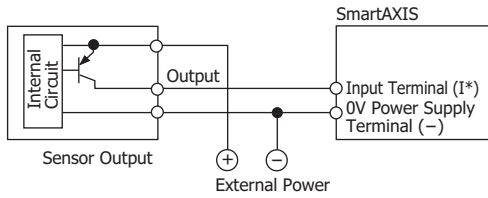

- Analog Output

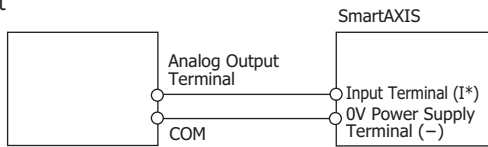

AC Power Type

Contact Input

- Contact Output

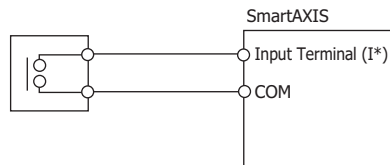

Sink/Source Input

- Contact Output

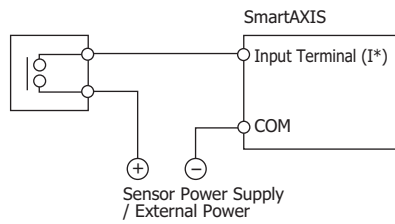

- NPN Output

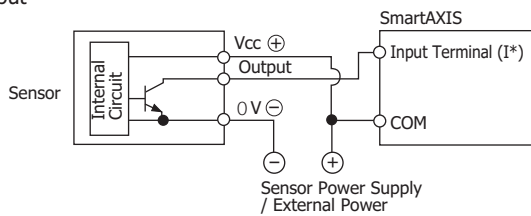

• PNP Output

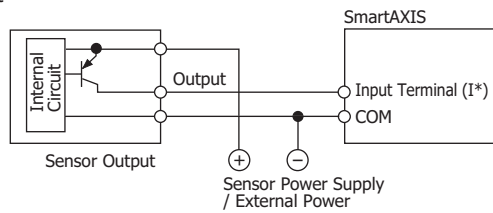

• 2-wire Sensor

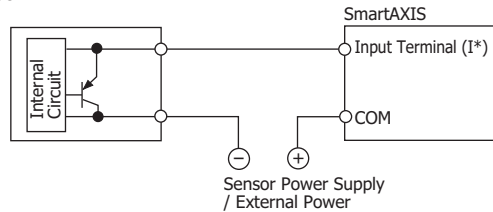

Output Terminal Wiring



Caution

- If output relays or transistors in the SmartAXIS or output modules should fail, outputs may remain on or off. For output signals which may cause heavy accidents, provide a monitor circuit outside the SmartAXIS.
- Connect a fuse to the output module, selecting a fuse appropriate for the load.
- Use proper wires for output wiring.
UL1015 AWG22 or UL1007 AWG18
- When equipment containing the SmartAXIS is intended for use in European countries, insert an IEC 60127-approved fuse to each output of every module for protection against overload or short-circuit. This is required when equipment containing the SmartAXIS is destined for Europe.
- When driving an inductive load that emits noise like a magnet or a valve, to reduce noise and protect circuits, use a diode for the output on DC power type models and a surge absorber for the output on AC power type models.
- Turn off the power to the SmartAXIS when wiring input/output terminals.
- Emergency stop and interlocking circuits must be configured outside the SmartAXIS.
- Use the input/output terminals within the SmartAXIS ratings and specifications.
- Tighten mounting screws with torque of 0.5N·m (5 gf·cm).

Output Protection Circuit

When a motor, solenoid, or similar inductive load is connected, the life of the contact is shortened due to the inrush current and counter-electromotive force acting on the load. Set up a protection circuit to prevent this from happening. Choose a protection circuit from A through D shown below, according to the power supply, and connect the protection circuit to the outside of the SmartAXIS.

For protection of the transistor output of the SmartAXIS modules, connect protection circuit C shown below to the transistor output circuit.

Protection Circuit A

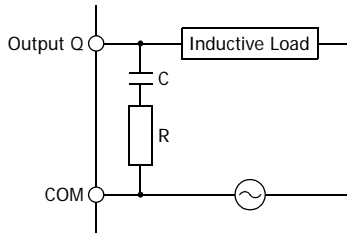

This protection circuit can be used when the load impedance is smaller than the RC impedance in an AC load power circuit.

R: Resistor of approximately the same resistance value as the load

C: 0.1 to 1 μ F

Protection Circuit B

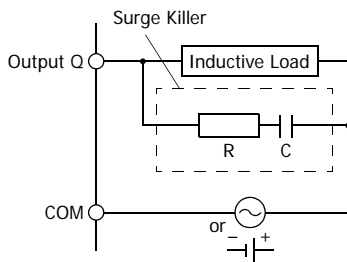

This protection circuit can be used for both AC and DC load power circuits.

R: Resistor of approximately the same resistance value as the load

C: 0.1 to 1 μ F

Protection Circuit C

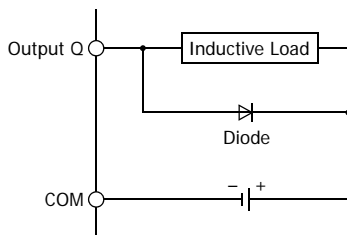

This protection circuit can be used for DC load power circuits.

Use a diode with the following ratings.

Reverse withstand voltage: Power voltage of the load circuit \times 10

Forward current: More than the load current

Protection Circuit D

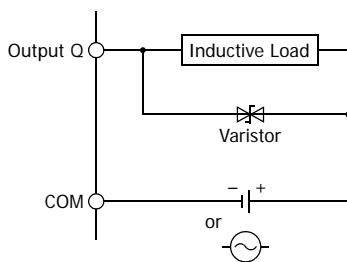

This protection circuit can be used for both AC and DC load power circuits.

Power Supply

This section describes how to connect a power supply to the SmartAXIS. The SmartAXIS is available in both AC and DC power types.



Caution

- Use a power supply of the rated value. Use of the wrong power supply may cause fire or malfunction.
- Ensure that the power voltage to the SmartAXIS does not exceed the allowable power voltage range described in the power supply specifications. The SmartAXIS may run and stop repeatedly within this voltage range, particularly if the power voltage turns on or off very slowly.
- Use an IEC 60127-approved fuse on the power line outside the SmartAXIS. This is required when equipment containing the SmartAXIS is destined for Europe.

AC Power Type

Connect the power supply to the AC power types, as shown below.

Example: **FT1A-*12**C**

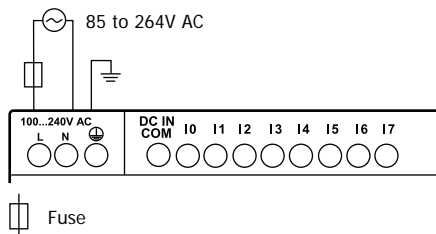

When Power Is Turned Off

The AC power types detect a power failure when the power voltage drops below 85V AC.

A momentary power interruption of 10ms or less is not recognized as a power failure when the power voltage is at the rated voltage.

Inrush Current at Powerup

When the SmartAXIS is powered up, there is an inrush current of a maximum of 35A flows. Use a power supply with sufficient capacity.

DC Power Type

Connect the power supply to the DC power types as shown below.

Example: **FT1A-*12**A**

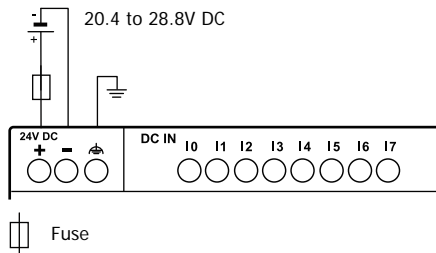

When Power Is Turned Off

The DC power types detect a power failure when the power voltage drops below 20.4V DC.



A momentary power interruption of 10ms or less is not recognized as a power failure when the power voltage is at the rated voltage.

Inrush Current at Powerup

When the SmartAXIS is powered up, there is an inrush current of a maximum of 30A flows. Use a power supply with sufficient capacity.

Power Supply Wiring

When connecting the power supply, be sure to take care of the following:

- Use a stranded wire of UL1015 AWG22 or UL1007 AWG18 for power supply wiring. Make the power supply wiring as short as possible.
- Run the power supply wiring as far away as possible from motor lines.
-  is the protective ground terminal. To prevent electric shocks, ground the terminal with D-type ground (type 3: ground resistance of 100Ω maximum).
-  is the functional ground terminal. To prevent malfunction or breakdown of the SmartAXIS due to noise, ground the terminal with D-type ground (class 3: ground resistance of 100Ω maximum).
- When connecting a stranded wire or multiple wires to a terminal block, use a ferrule.

Caution

- Use the SmartAXIS within the specifications of ratings and environmental conditions. Failure to do so may cause the SmartAXIS to break down or reduce product life.
- Be sure to connect the grounding wire to a proper ground, otherwise electrical shocks may be caused.
- Do not touch live terminals, otherwise electrical shocks may be caused.
- When connecting the power supply, tighten the terminal screws with torque of 0.5N·m (5kgf·cm).

Grounding

When grounding the power supply, be sure to take care of the following:

- Do not use the common ground for the SmartAXIS and motor equipment. The common ground can be used only when the length of grounding wires for those devices are the same.
- Use a ground wire of UL1007 AWG16.
- Use a thick wire for grounding the SmartAXIS and make the grounding wire as short as possible to make sure that noises from external devices can be conducted to the ground effectively.
- As shown below, external devices generating noise must be separated from the SmartAXIS and grounded with the D-type ground (class 3).
- Make the length of the grounding wire for the SmartAXIS as short as possible.

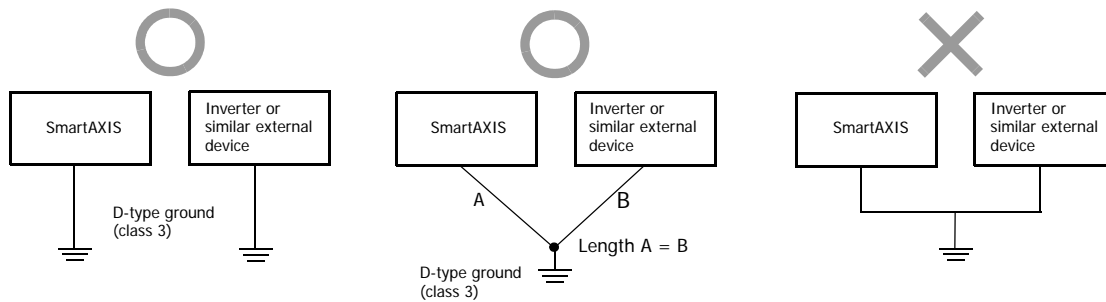

Terminal Connection

This section describes types of terminals and how to use them.

When connecting stranded wire or multiple solid wires to a terminal block, use appropriate ferrule for the terminal block.



Caution

- Do not touch live terminals, otherwise electrical shocks may be caused.
- When the power is on, terminals to which external devices are connected may be heated. Do not touch terminals immediately after the power is turned off.
- Do not touch terminals immediately after the power is turned off, otherwise electrical shocks may be caused.
- When connecting a stranded wire or multiple solid wires to a screw terminal block, use a ferrule. Otherwise the wire may slip off the screw terminal block.
- When using ferrules, insert a wire to the bottom of the ferrule and crimp the ferrule.

Terminals for Terminal Blocks

Crimp ferrules using an appropriate tool according to the size of ferrules. Cut the end of the wire to the same length or about 0.5 mm longer than the ferrule.

Ensure that the core wire does not protrude at the end of the shield and there are no whiskers.

2-wire connection

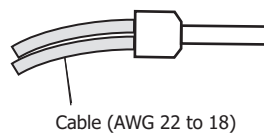

1-wire connection

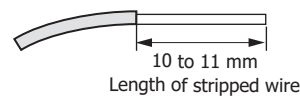
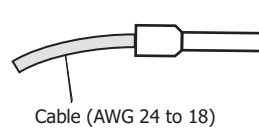

Length of stripped wire
Single Wire: AWG 16 to 12 (UL)
Stranded Wire: AWG 12 to 14 (JIS)

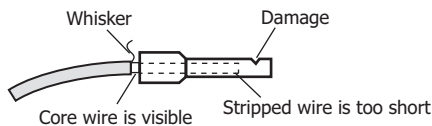
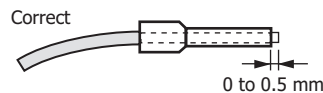

Ferrules

The ferrules and crimping tools below can be used.

Type numbers of the ferrules and crimping tool are the type numbers of Phoenix Contact.

Ferrule Order No.

Quantity of Cables	Cable Size	Phoenix Type	Order No.	Pcs./Pkt.
For 1-wire connection	UL1007 AWG16	AI 1,5-8 BK	32 00 04 3	100
	UL1007 AWG18	AI 1-8 RD	32 00 03 0	100
	UL1015 AWG22	AI 0,5-8 WH	32 00 01 4	100
	UL2464 AWG24	AI 0,25-8 YE	32 03 03 7	100
For 2-wire connection	UL1007 AWG18	AI-TWIN 2 x 0,75-8 GY	32 00 80 7	100
	UL1015 AWG22	AI-TWIN 2 x 0,5-8 WH	32 00 93 3	100

Crimping Tool Order No.

Tool Name	Phoenix Type	Order No.	Pcs./Pkt.
Crimping Tool	CRIMPFOX ZA 3	12 01 88 2	1

Securing the Panel Attachment USB Extension Cable

Using the panel attachment USB extension cable^{*1} makes it possible to perform maintenance on a SmartAXIS installed in a control panel from the surface of the panel. When using the panel attachment USB extension cable, we recommend securing it to the USB port cover with a cable tie^{*2} so that it does not come loose from the SmartAXIS.

This section describes the procedure to secure the USB extension cable to the USB cover.

1. Open the SmartAXIS USB port cover and plug the panel attachment USB extension cable into the USB port.

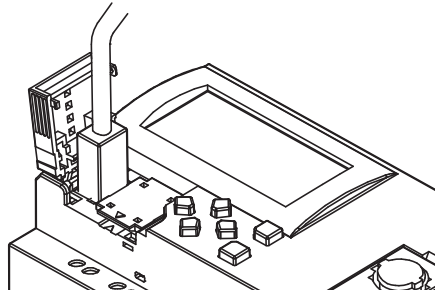

2. Wrap the cable tie around the USB port cover and the panel attachment USB extension cable.

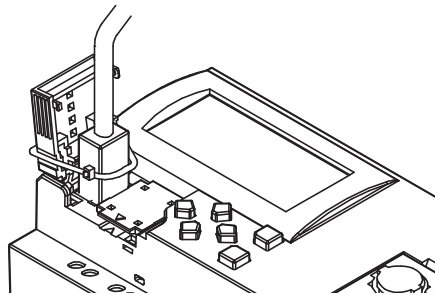

3. The cable tie can also be inserted through the holes on the USB port cover.

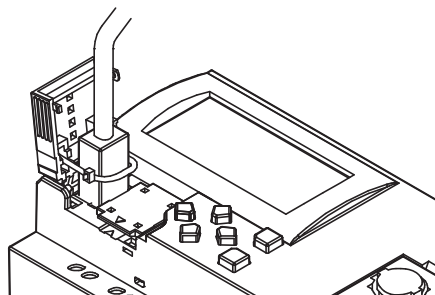

4. Tighten the loop until it is the suitable size and trim the excess cable tie using wire cutters.

Note 1: We recommend the panel attachment USB extension cable (part no.: HG9Z-XCE21).

Note 2: HellermanTyton cable tie T18R-1000 is recommended.

4: OPERATION BASICS

Introduction

This chapter describes basic procedures for operating WindLDR, programming and maintenance software for the SmartAXIS Pro/Lite series.

Note: SmartAXIS Touch series use WindO/I-NV3 software for programming. See the “SmartAXIS Touch User’s Manual” for instructions for programming and basic operation of WindO/I-NV3 with the Touch series.

Start WindLDR

From the Start menu of Windows, select **Programs > Automation Organizer V2 > WindLDR > WindLDR**.

WindLDR starts and a blank ladder editing screen appears with menus and tool bars shown on top of the screen.

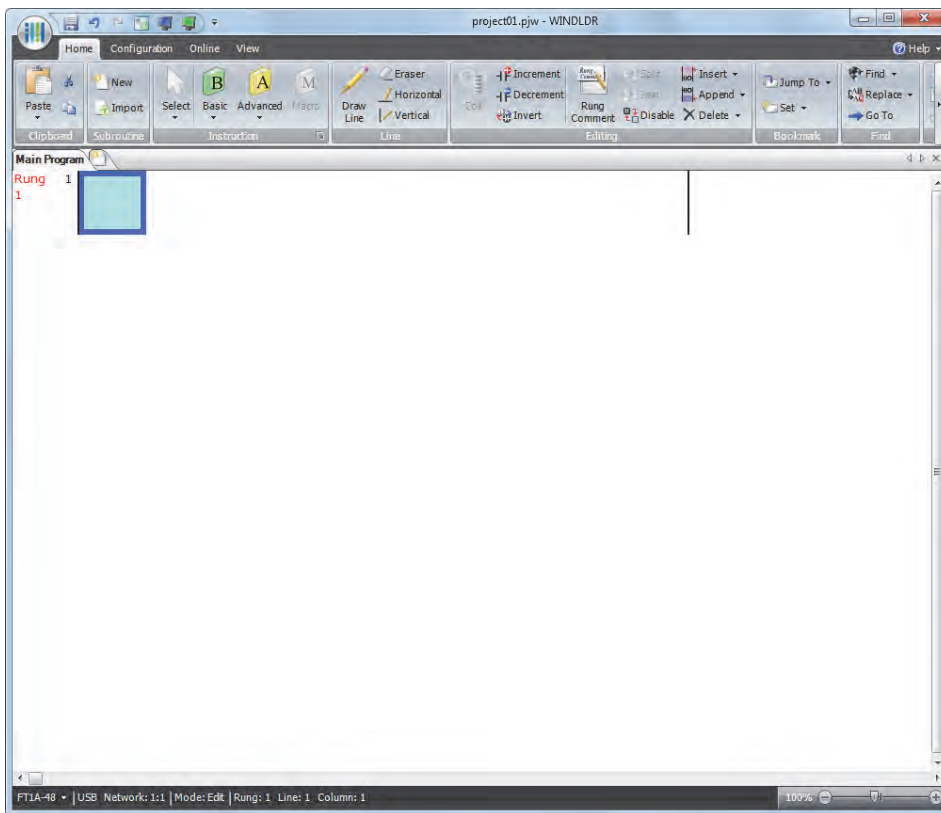

PLC Selection

Before programming a user program on WindLDR, select a PLC type.

1. Select **Configuration** from the WindLDR menu bar, then select **PLC Type**.
The PLC Selection dialog box appears.

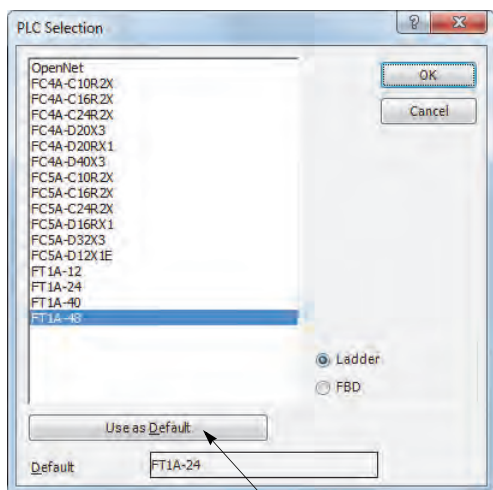

Press this button, then the same PLC will be selected as default when WindLDR is started next time.

PLC Selection Option	SmartAXIS Type No.
FT1A-12	FT1A-H12RA
	FT1A-B12RA
	FT1A-H12RC
	FT1A-B12RC
FT1A-24	FT1A-H24RA
	FT1A-B24RA
	FT1A-B24RC
FT1A-40	FT1A-H40RKA
	FT1A-H40RSA
	FT1A-B40RKA
	FT1A-B40RSA
	FT1A-H40RC
FT1A-48	FT1A-B40RC
	FT1A-H48KA
	FT1A-H48SA
	FT1A-B48KA
	FT1A-B48SA
	FT1A-H48KC
FT1A-H48SC	
FT1A-B48KC	
FT1A-B48SC	

2. Select a PLC type in the selection box and the programming language to use.
3. Click **OK**.
PLC selection is now complete. For the procedure to create the ladder program, see "Create Ladder Program" on page 4-3. For the procedure to create the ladder program, see "Create FBD Program" on page 4-7.

Create Program

Create Ladder Program

This section describes the procedure for creating a simple ladder program in WindLDR.

Note: See SmartAXIS Ladder Programming Manual for details on basic and advanced instructions.

Sample User Program

Create a simple program using WindLDR. The sample program performs the following operation:

When only input I0 is turned on, output Q0 is turned on.

When only input I1 is turned on, output Q1 is turned on.

When both inputs I0 and I1 are turned on, output Q2 flashes in 1-sec increments.

Rung No.	Input I0	Input I1	Output Operation
1	ON	OFF	Output Q0 is turned ON.
2	OFF	ON	Output Q1 is turned ON.
3	ON	ON	Output Q2 flashes in 1-sec increments.

Note: One collection of a group of instructions that control output or advanced instructions is called a rung. WindLDR manages programs in rung units. Function descriptions can be configured as rung comments for individual rungs.

Start WindLDR

From the Start menu of Windows, select **Programs > Automation Organizer V2 > WindLDR > WindLDR**.

WindLDR starts and a blank ladder editing screen appears with menus and tool bars shown on top of the screen.

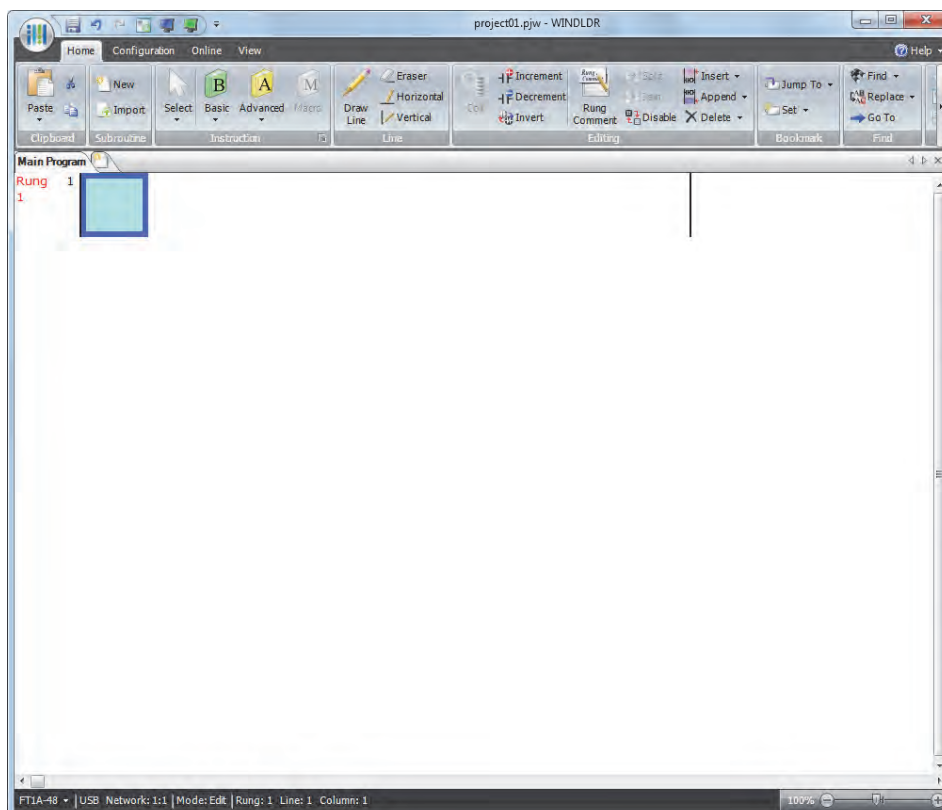

Edit User Program Rung by Rung

Start the user program with the LOD instruction by inserting a NO contact of input I0.

1. From the WindLDR menu bar, select **Home > Basic > A (Normally Open)**.

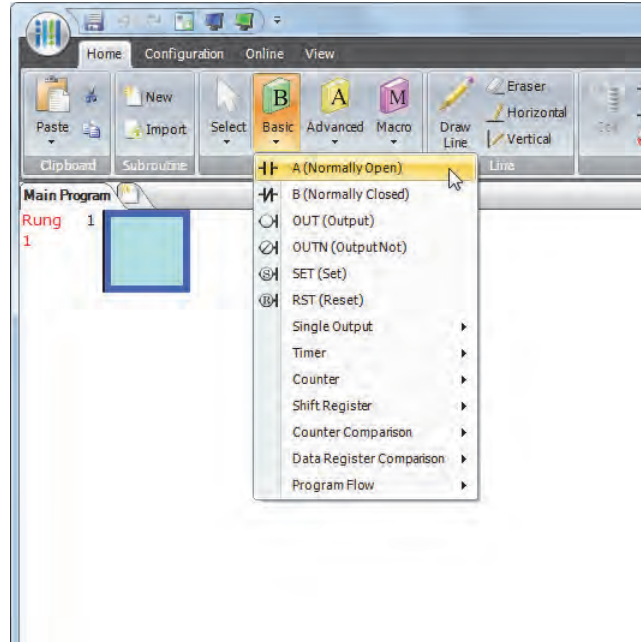

2. Move the mouse pointer to the first column of the first line where you want to insert a NO contact, and click the left mouse button.

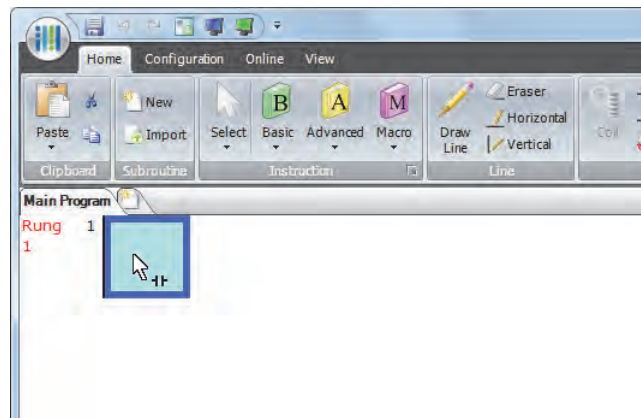

Note: Another method to insert a NO (or NC) contact is to move the mouse pointer where you want to insert the contact, and type A (or B). The Normally Open dialog box appears.

- Enter **I0** in the Tag Name field, and click **OK**.

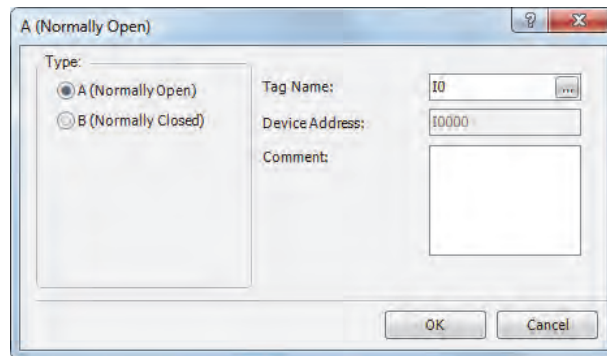

A NO contact of input I0 is programmed in the first column of the first ladder line.

Next, program the ANDN instruction by inserting a NC contact of input I1.

- From the WindLDR menu bar, select **Home > Basic > B (Normally Closed)**.
- Move the mouse pointer to the second column of the first ladder line where you want to insert a NC contact, and click the left mouse button.
The Normally Closed dialog box appears.
- Enter **I1** in the Tag Name field, and click **OK**.

An NC contact of input I1 is programmed in the second column of the first ladder line.

At the end of the first ladder line, program the OUT instruction by inserting a NO coil of output Q0.

- From the WindLDR menu bar, select **Home > Basic > OUT (Output)**.
- Move the mouse pointer to the third column of the first ladder line where you want to insert an output coil, and click the left mouse button.

Note: Another method to insert an instruction (either basic or advanced) is to type the instruction symbol, OUT, where you want to insert the instruction.

The Output dialog box appears.

- Enter **Q0** in the Tag Name field, and click **OK**.
A NO output coil of output Q0 is programmed in the right-most column of the first ladder line. This completes programming for rung 1.

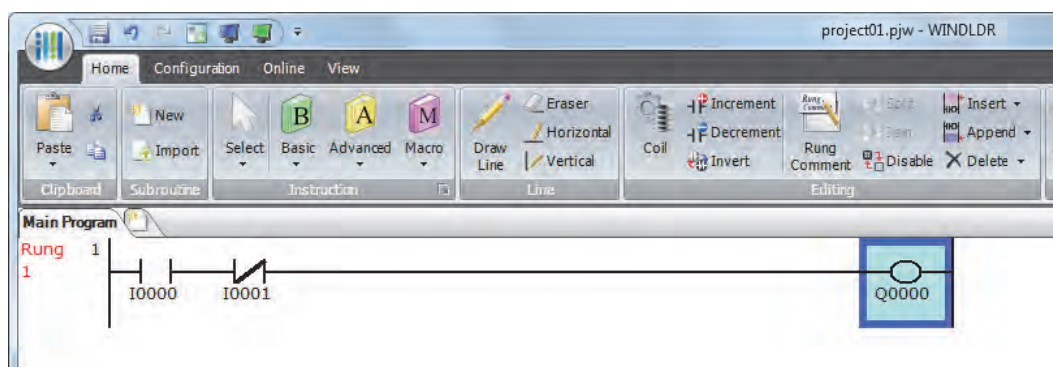

Continue programming for rungs 2 and 3 by repeating similar procedures.

A new rung is inserted by pressing the **Enter** key while the cursor is on the preceding rung. A new rung can also be inserted by selecting **Home > Append > Append a Rung**.

4: OPERATION BASICS

When completed, the ladder program looks like below.

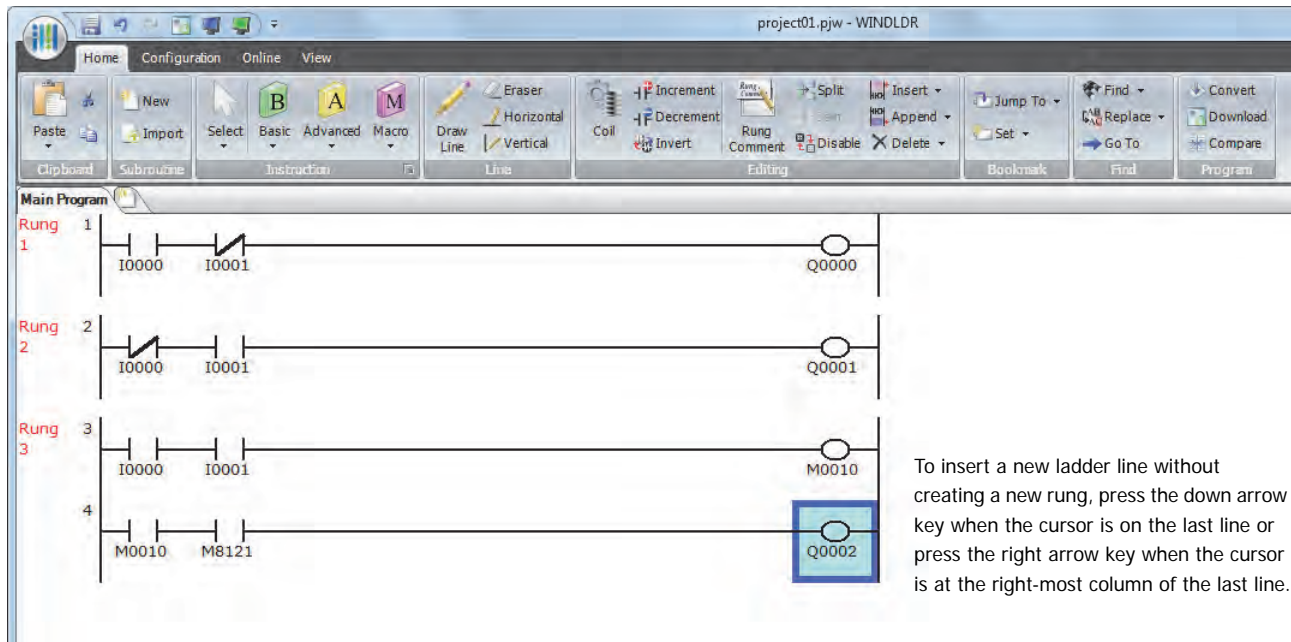

To insert a new ladder line without creating a new rung, press the down arrow key when the cursor is on the last line or press the right arrow key when the cursor is at the right-most column of the last line.

Create FBD Program

This section describes the procedure for creating a sample FBD program in WindLDR.

Note: For details on each FB, see the "SmartAXIS FBD Programming Manual".

Create a program that operates in the following manner.

- When both input I0 and input I1 are on, output Q0 turns on.
- When either input I1 or input I2 is on, output Q1 continues to turn on and off in a one second cycle.

Circuit block	I0	I1	I2	Action
Q0	ON	ON	—	Turn output Q0 on
Q1	—	OFF	ON	Turn on and off the output Q1 continuously in a one second cycle
	—	ON	OFF	

Note: The output FB and all the FBs connected on the left side of the input connector of the output FB are called the circuit block. The output state of the output FB is the execution result of a single circuit block.

Insert input I0

1. From the WindLDR menu bar, click **Home > Function Block > Terminal > I (Digital Input)**.

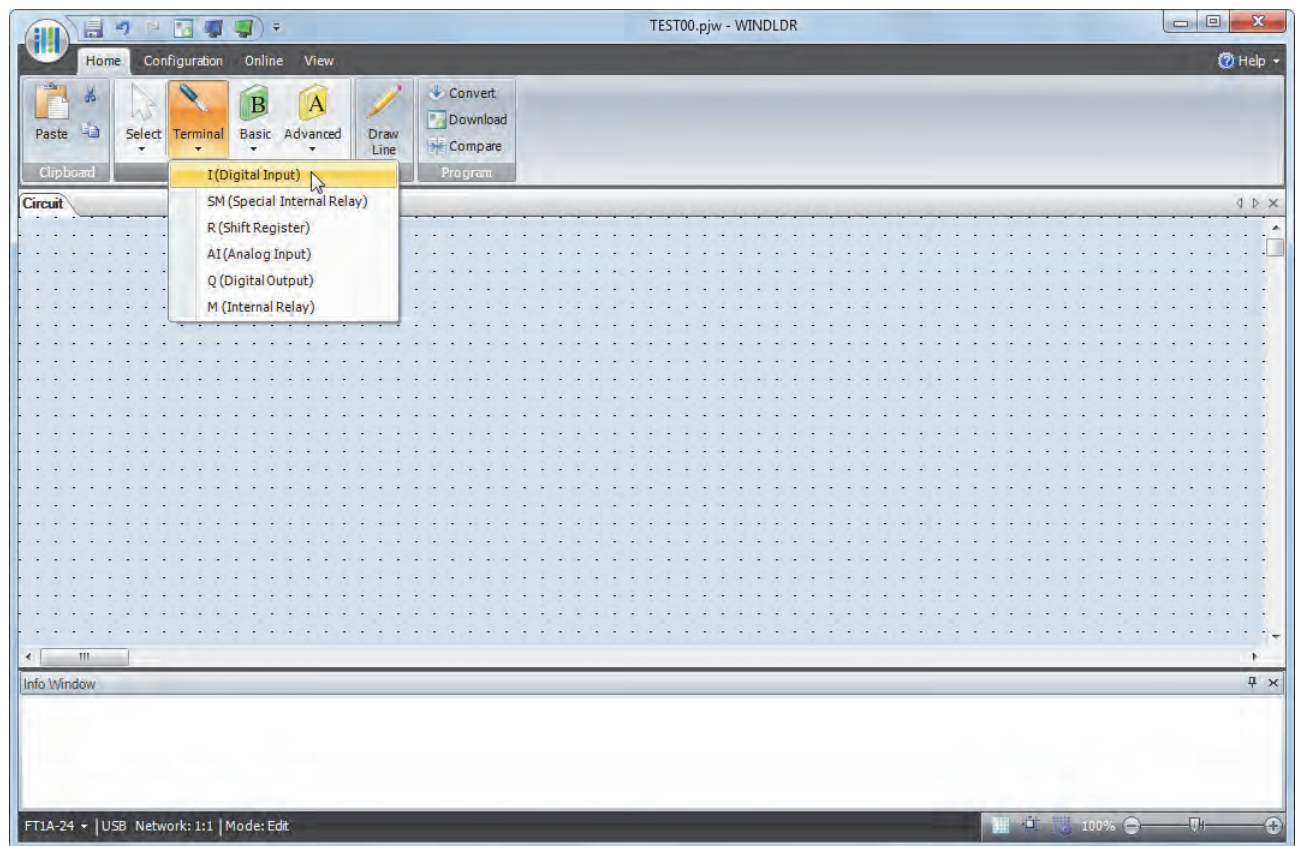

2. Move the mouse pointer to the FBD editor and click the left mouse button.

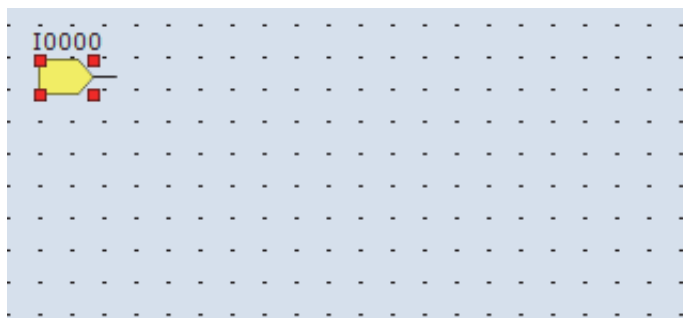

Input I0 is inserted at the position of the mouse pointer.

4: OPERATION BASICS

Insert the AND (logical AND) FB

1. From the WindLDR menu bar, click **Home > Function Block > Basic > AND (Logical AND)**.

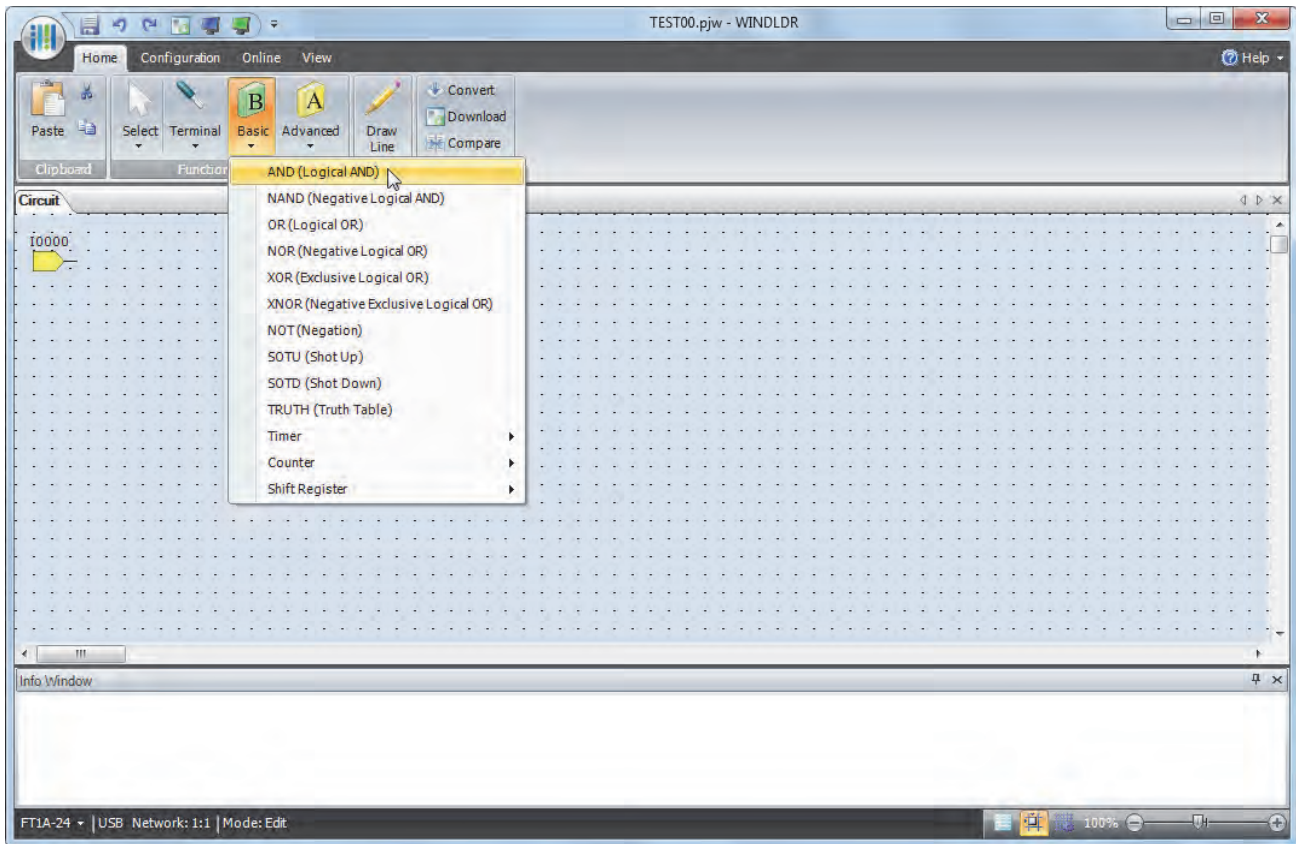

2. Move the mouse pointer to the FBD editor and click the left mouse button.

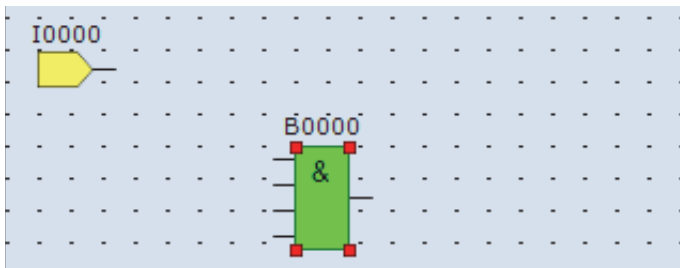

AND B0 is inserted at the position of the mouse pointer.

Connect input I0 and AND B0 with a connection line

1. From the WindLDR menu bar, click **Home > Line > Draw Line**.

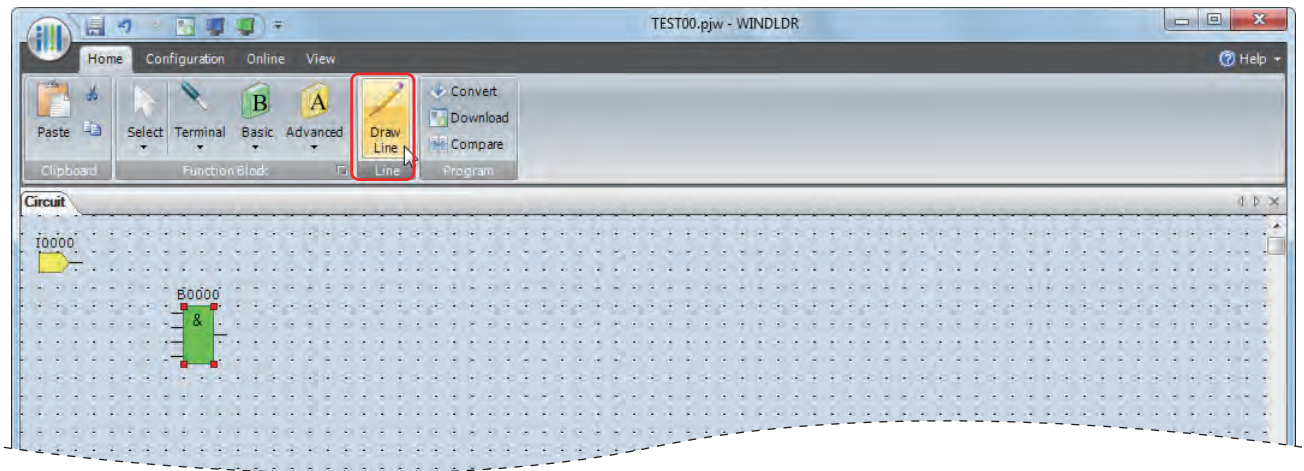

2. Move the mouse pointer to the input I0 output connector.

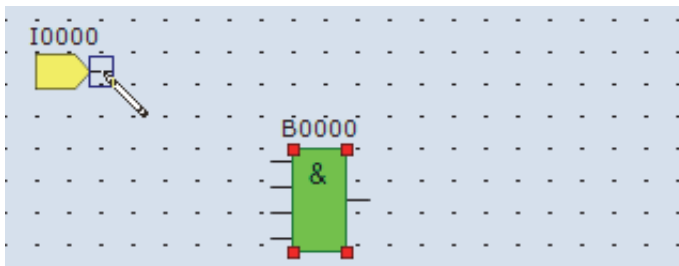

3. Click the left mouse button and drag the line to the AND B0 input 1 connector.

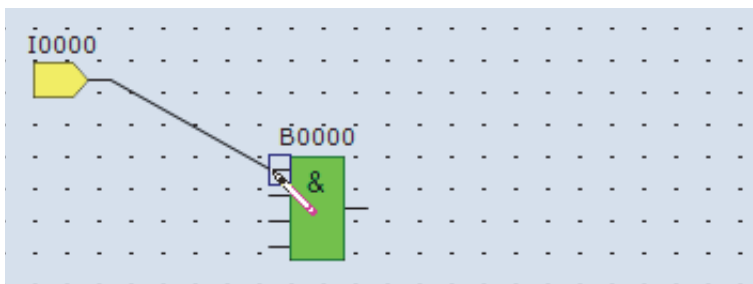

4. Release the mouse button.

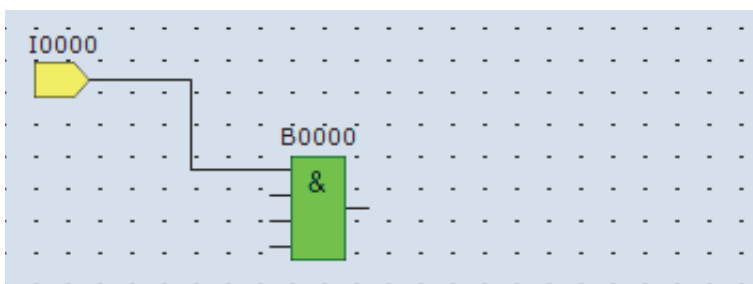

The output connector of the input I0 and the input 1 connector of the AND B0 are connected.

4: OPERATION BASICS

Insert output Q0 and connect it to the output connector of AND B0

1. From the WindLDR menu bar, click **Home > Function Block > Terminal > Q (Digital Output)**.

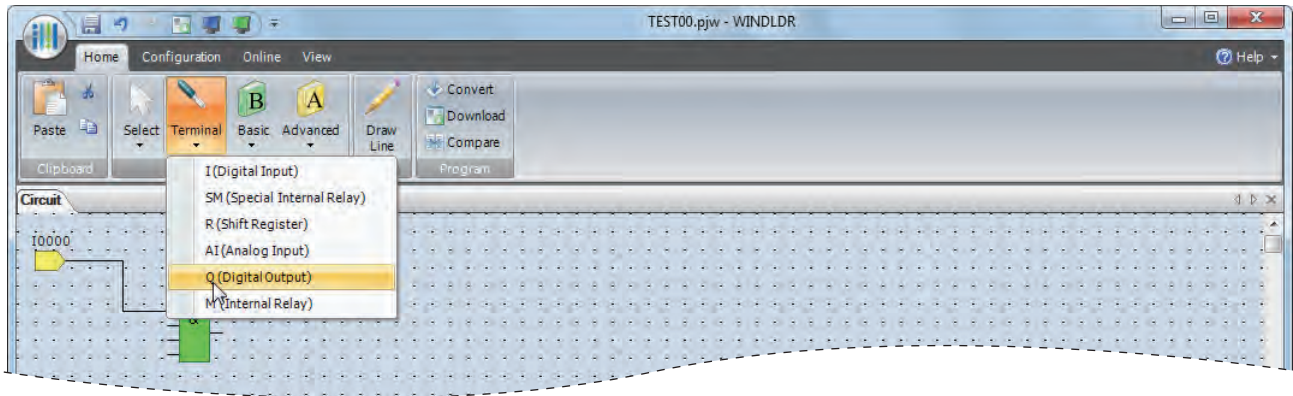

2. Move the mouse pointer to the FBD editor and click.

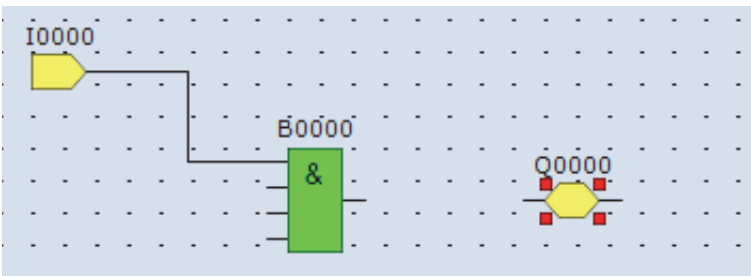

Output Q0 is inserted at the position of the mouse pointer.

3. Connect the output connector of AND B0 and input connector of the output Q0 with a connection line.
Connect them in the same manner as "Connect input I0 and AND B0 with a connection line" on page 4-9.

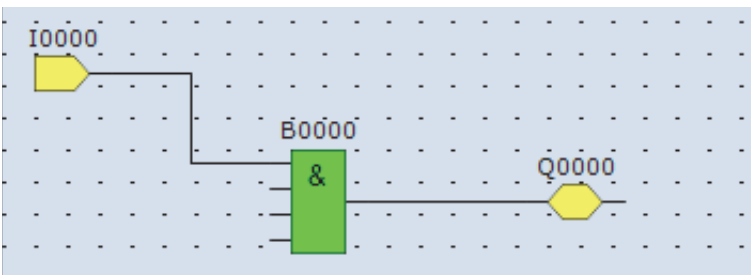

Insert input I1 and connect it to the input 2 of AND B0

Insert input I1 in the same manner as "Insert input I0" on page 4-7 and connect it to the input 2 of AND B0 with a connection line in the same manner as "Connect input I0 and AND B0 with a connection line" on page 4-9.

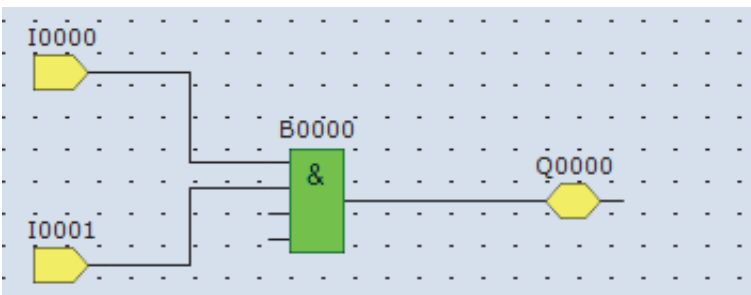

Insert input I2 and XOR B1. Connect input I1 and I2 to the inputs 1 and 2 of XOR B1.

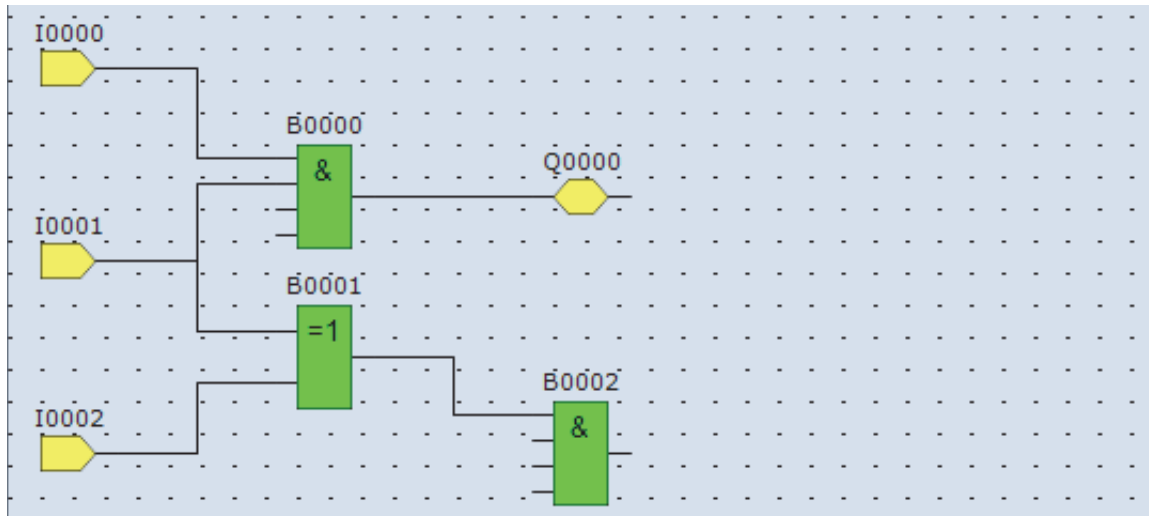

The output connector of the FB can be connected to multiple FB input connectors. Multiple output connectors of FBs cannot be connected to a single input connector of an FB.

Insert special internal relay M8121, AND B2, and output Q1 and connect them.

Note: M8121 is a special internal relay that continuously turns on and off in a one second cycle. For details on the special internal relay, see "Special Internal Relay Device Addresses" on page 7-2.

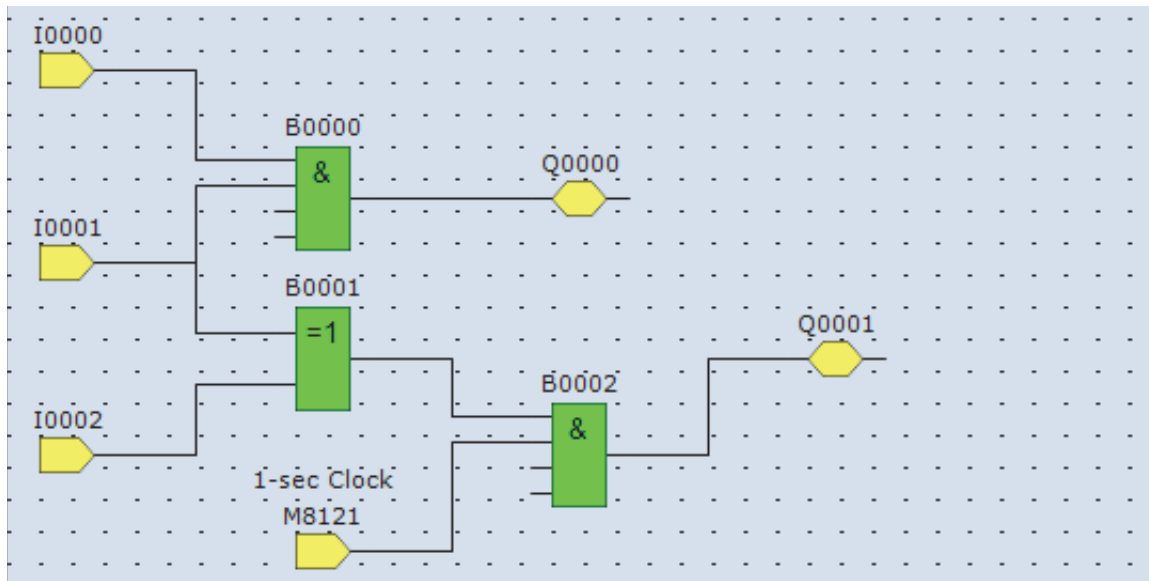

Creating the sample FBD program is now complete.

Convert Program

The program can be checked whether it contains any user program syntax error.

From the menu bar, select **Home > Convert (Program group)**.

When the instruction/FB symbols are connected correctly, the program conversion is completed successfully. If any error is found, the errors are listed on the Info Window. Then, make corrections as necessary.

Save Project

1. Select the WindLDR application button at the upper-left corner of the WindLDR screen, followed by **Save**, and type **TEST01** in the File Name field. Change the Folder or Drive as necessary.

Simulate Operation

Before downloading the user program, you can simulate the operation on the WindLDR screen without connecting the SmartAXIS.

Ladder Program

From the WindLDR menu bar, select **Online > Simulation**. The Simulation screen appears.

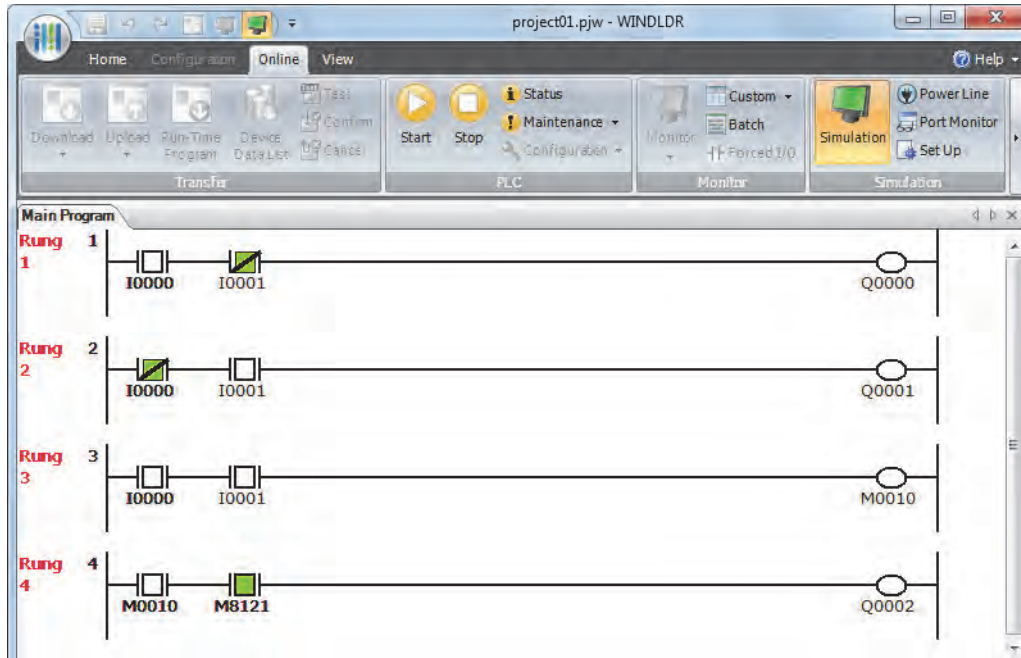

To change an input status, place the mouse pointer on the input and right-click the mouse. In the pop-up menu, select Set or Reset to set or reset the input.

To quit simulation, from the WindLDR menu bar, select **Online > Simulation**.

For FBD Program

1. From the WindLDR menu bar, select **Online > Simulation > Simulation**.
2. Double-click the input FB to change the state.

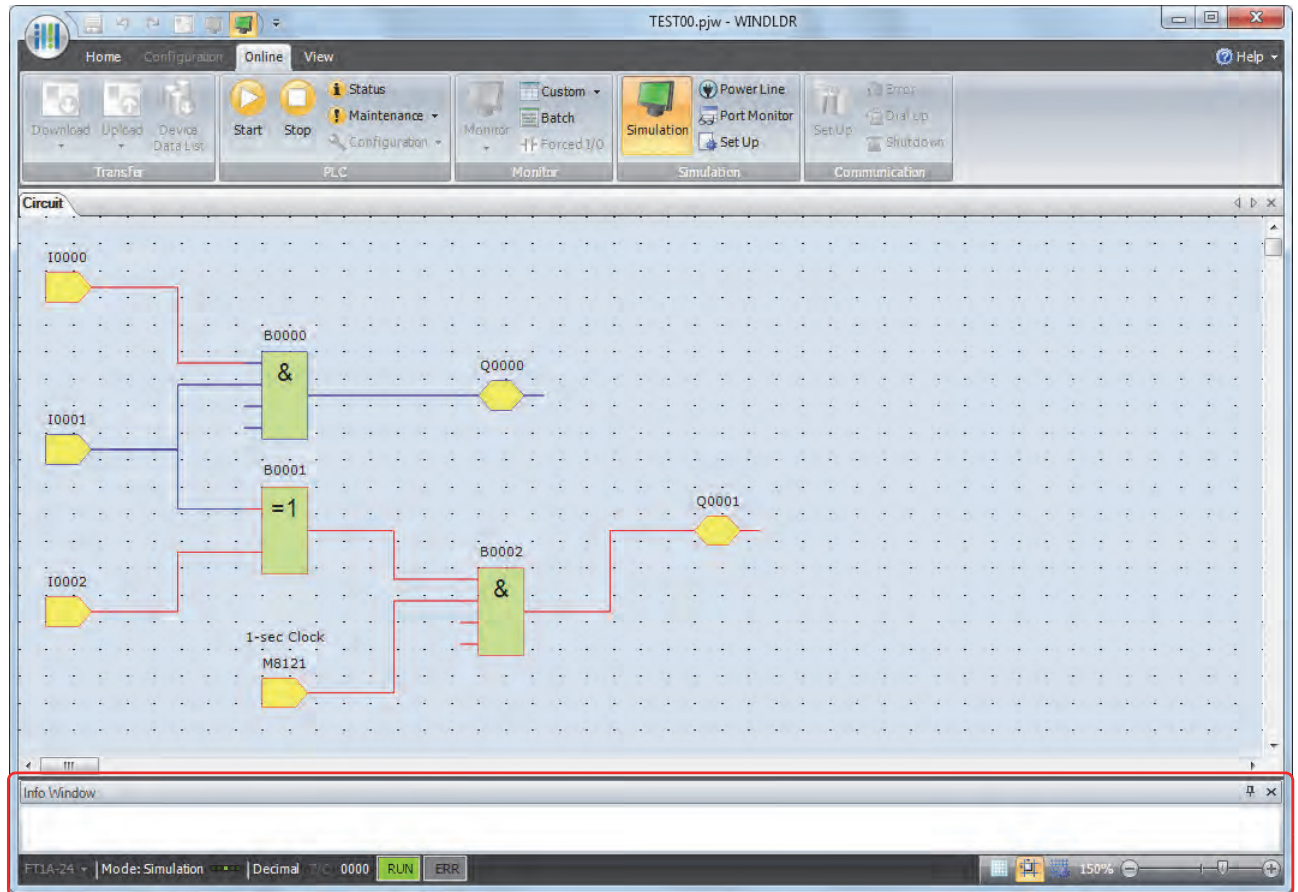

WindLDR

- When you turn on both input I0 and input I1, output Q0 turns on.
- When you turn on either input I1 or input I2, output Q1 continues to turn on and off in a one second cycle.

Notes:

- To quit the simulation, select **Online > Simulation > Simulation** again.
- You can check the state of the input connectors and output connectors of each FB. When input connectors, output connectors, and connection lines are in red, they are on. Blue indicates off.
- For details on the state of unconnected input connectors of the FBs, see the "SmartAXIS FBD Programming Manual".

Download Program

While WindLDR is running on a PLC, you can download the user program to the SmartAXIS.

User programs can be downloaded to the SmartAXIS from WindLDR using USB or Ethernet. This section describes the all the procedures from configuring communication settings to downloading a user program to the SmartAXIS via USB.

To use a USB, the SmartAXIS USB port must be connected to a computer using a USB cable.

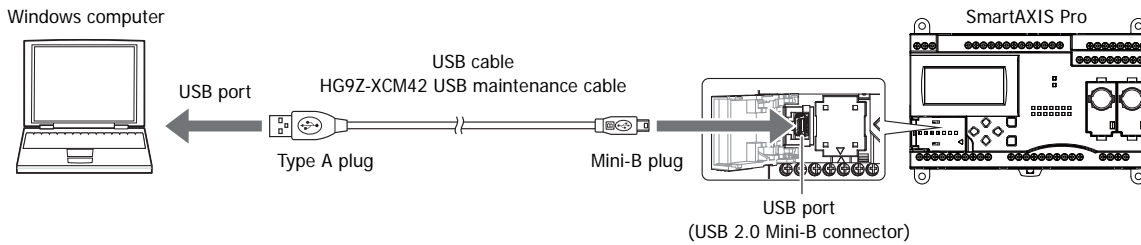

Note: In order for WindLDR to communicate with the SmartAXIS via USB, a dedicated USB driver must be installed on the computer. See "USB Driver Installation Procedure" on page A-5.

1. From the WindLDR menu bar, select **Online > Set Up**.
2. The Communication Settings dialog box appears. Click the **USB** tab and then click **OK**. The communication method is now set to USB. Next, download a user program.
3. From the WindLDR menu bar, select **Online > Download**. The Download dialog box appears, then click **OK**. The user program is downloaded to the SmartAXIS.

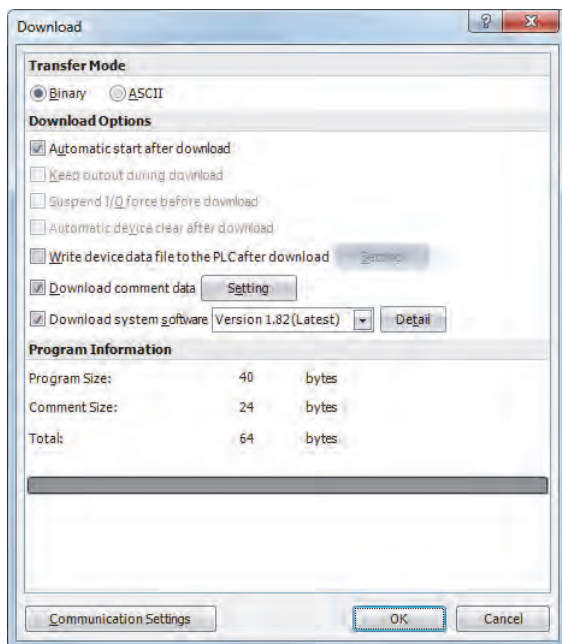

Note: The Download dialog box can also be opened by selecting **Home > Download**.

Note: When downloading a user program, all values and selections in the Function Area Settings are also downloaded to the SmartAXIS. For details on function settings, see "Special Functions" on page 5-1.

Monitor Operation

Another powerful function of WinLDR is to monitor the PLC operation on the computer. The input and output statuses of the sample program can be monitored in the ladder diagram.

Ladder Program

From the WinLDR menu bar, select **Online > Monitor > Monitor**.

When both inputs I0 and I1 are on, the ladder diagram on the monitor screen looks as follows:

The screenshot displays the WinLDR software interface in monitor mode. The main window shows a ladder logic diagram with four rungs. The status bar at the bottom indicates 'Force Suspended'.

Rung 1:
When both inputs I0 and I1 are on, output Q0 is turned off.

Rung 2:
When both inputs I0 and I1 are on, output Q1 is turned off.

Rung 3:
When both input I0 and I1 are on, internal relay M10 is turned on. M8121 is the 1-sec clock special internal relay.

Rung 4:
While M10 is on, output Q2 flashes in 1-sec increments.

4: OPERATION BASICS

FBD Program

1. After the program is successfully downloaded, from the WindLDR menu bar, select **Online > Monitor > Monitor**. The SmartAXIS state is displayed on the WindLDR screen.

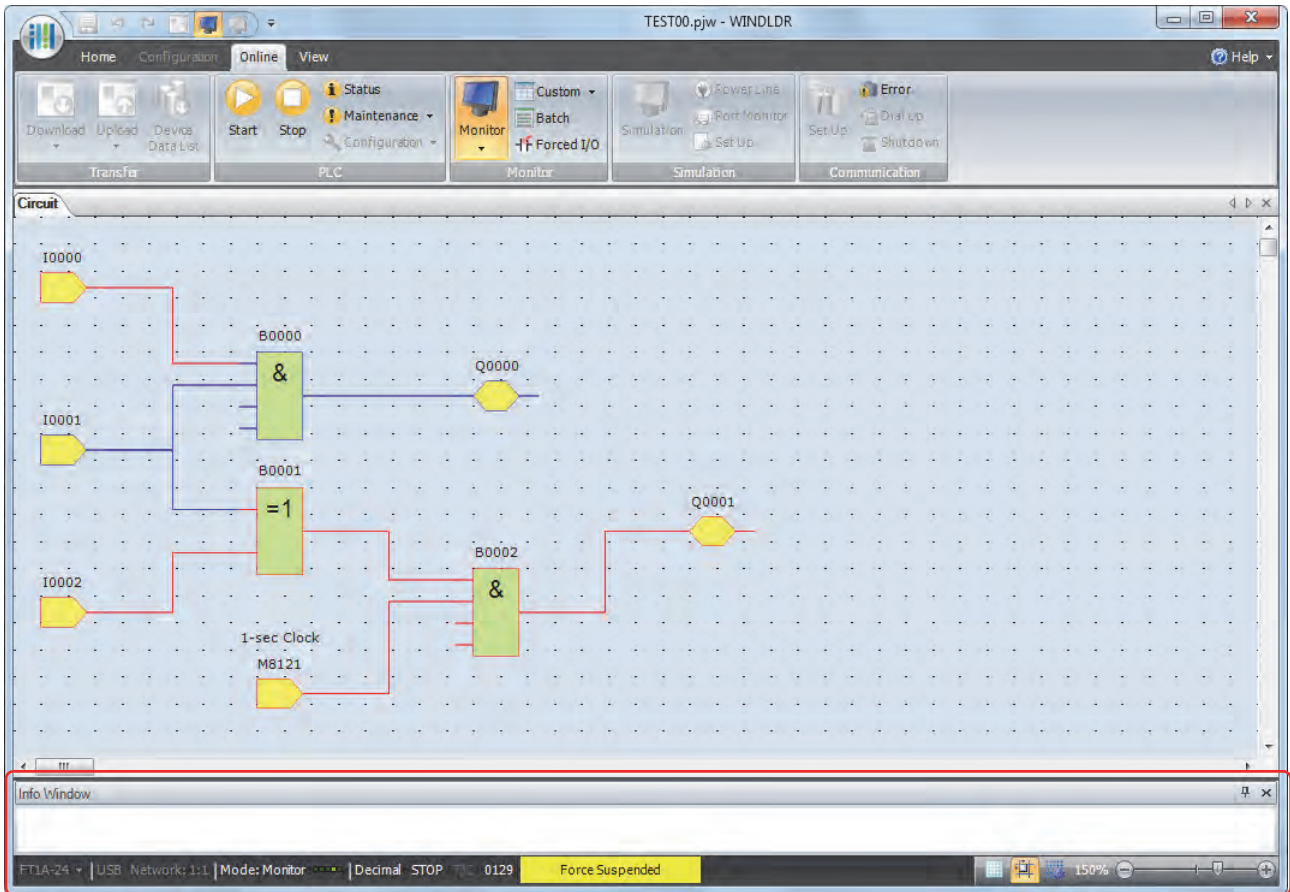

WindLDR

2. Check the following operations.
 - When you turn on both input I0 and input I1, output Q0 turns on.
 - When you turn on either input I1 or input I2, output Q1 continues to turn on and off in a one second cycle.

Checking the operation is now complete.

Notes:

- You can check the state of the input connectors and output connectors of each FB. When input connectors, output connectors, and connection lines are in red, they are on. Blue indicates off.
- For details on the state of unconnected input connectors of the FBs, see the " SmartAXIS FBD Programming Manual".

Exit WindLDR

When you have completed monitoring, you can exit WindLDR either directly from the monitor screen or from the editing screen. In both cases, from the WindLDR application button, click **Exit WindLDR**.

Start/Stop Operation

This section describes operations to start and stop the SmartAXIS and to use the stop and reset inputs.



Caution

- Make sure of safety before starting and stopping the SmartAXIS. Incorrect operation of the SmartAXIS may cause machine damage or accidents.

Start/Stop Schematic

The start/stop circuit of the SmartAXIS consists of three blocks; power supply, M8000 (start control special internal relay), and stop/reset inputs. Each block can be used to start and stop the SmartAXIS while the other two blocks are set to run the SmartAXIS.

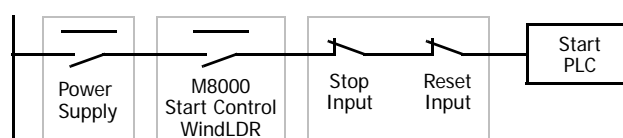

Start/Stop Operation Using WindLDR

The SmartAXIS can be started and stopped using WindLDR run on a Windows computer connected to the SmartAXIS. When the **Start** button is pressed in the menu bar shown below, start control special internal relay M8000 is turned on to start the SmartAXIS. When the **Stop** button is pressed, M8000 is turned off to stop the SmartAXIS.

1. Connect the computer to the SmartAXIS, start WindLDR, and power up the SmartAXIS.
2. Check that a stop input is not designated using **Configuration > Run/Stop Control > Stop and Reset Inputs**. See "Stop Input and Reset Input" on page 5-4.

Note: When a stop input is designated, the SmartAXIS cannot be started or stopped by turning start control special internal relay M8000 on or off.

3. Select **Online** from the WindLDR menu bar.
The Online tab appears.

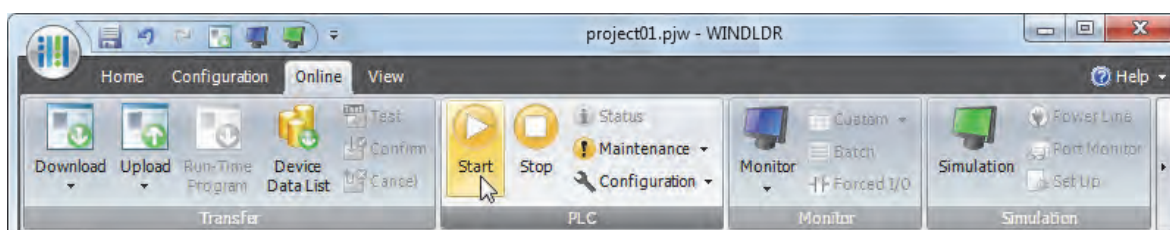

4. Click the **Start** button to start operation, then the start control special internal relay M8000 is turned on.
5. Click the **Stop** button to stop operation, then the start control special internal relay M8000 is turned off.
The PLC operation can also be started and stopped while WindLDR is in the monitor mode. Select **Online > Monitor > Monitor** and click the **Start** or **Stop** button.

Note: Special internal relay M8000 is a keep type internal relay and stores the status when power is turned off. M8000 retains its previous status when power is turned on again. However, when the backup battery is dead, M8000 loses the stored status, and can be turned on or off as programmed when the SmartAXIS is powered up. The selection is made in **Configuration > Run/Stop Control > Run/Stop Selection at Memory Backup Error**. See "Run/Stop Selection at Memory Backup Error" on page 5-5.

The backup duration is approximately 30 days (typical) at 25°C after the backup battery is fully charged.

4: OPERATION BASICS

Start/Stop Operation Using the Power Supply

The SmartAXIS can be started and stopped by turning power on and off.

1. Power up the SmartAXIS to start operation.
2. Turn power on and off to start and stop operation.

Order of Powerup and Powerdown

To turn the power on, turn on the SmartAXIS and I/O sides at the same time, or turn on the I/O side first, followed by the SmartAXIS side.

To turn the power off, turn off the SmartAXIS and I/O sides at the same time, or turn off the SmartAXIS side first, followed by the I/O side.

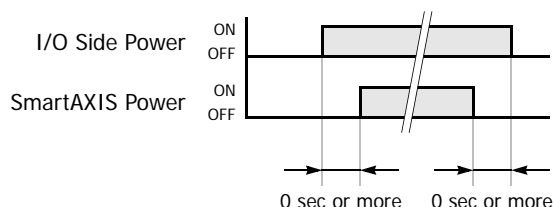

Start/Stop Operation Using Stop Input and Reset Input

Any input terminal available on the SmartAXIS can be designated as a stop or reset input using the Function Area Settings. The procedure for selecting stop and reset inputs is described "Stop Input and Reset Input" on page 5-4.

Note: When using a stop and/or reset input to start and stop operation, make sure that start control special internal relay M8000 is on. If M8000 is off, the SmartAXIS does not start operation when the stop or reset input is turned off. M8000 is not turned on or off when the stop and/or reset input is turned on or off.

When a stop or reset input is turned on during program operation, the SmartAXIS stops operation, and all outputs are turned off. The reset input has priority over the stop input.

System Statuses at Stop, Reset, and Restart

The system statuses during running, stop, reset, and restart after stopping are listed below:

Mode	Output	Internal Relay, Shift Register, Counter, Data Register		Special Internal Relay	Special Data Register	Non-Maintained Data Register	Timer Current Value
		Keep Type	Clear Type				
Run	Operating	Operating	Operating	Operating	Operating	Operating	Operating
Stop	OFF	Unchanged	Unchanged	See Chapter 7	Unchanged	Unchanged	Unchanged
Restart	Unchanged	Unchanged	OFF/ Reset to zero	Unchanged	Unchanged	Unchanged	Reset to preset
Reset (Reset input ON)	OFF	OFF/ Reset to zero	OFF/ Reset to zero	Unchanged	Unchanged	OFF/ Reset to zero	Reset to zero
Power OFF	OFF	Unchanged	Unchanged	See Chapter 7	Unchanged	OFF/ Reset to zero	Reset to zero

5: SPECIAL FUNCTIONS

Introduction

The SmartAXIS supports many features in addition to instructions/FB.

For functions that require advanced setup including the functions to upload, download, and protect user programs and the network settings, first configure those settings on the Function Area Settings dialog, and then download the user program to the SmartAXIS. Constant scan time and forced I/O can be used without advanced setup.

This chapter describes the SmartAXIS special functions, how to configure them, and examples of their use.

Function List

Function name	Overview	Reference	Setup location
Stop input	The SmartAXIS can be started/stopped with a specified input.	5-4	Function area settings
Reset input	The device values of the SmartAXIS can be cleared with a specified input.	5-4	
Run/stop selection at memory backup error	Whether to start or stop the SmartAXIS when the SmartAXIS is powered up after the "keep" data in the RAM has been lost can be specified.	5-5	
Run/stop selection at power up	Whether to start or stop the SmartAXIS regardless of the M8000 status when the SmartAXIS is powered up can be specified.	5-6	
Keep and clear devices	Whether to clear or keep the device values, such as counter current values, when the SmartAXIS starts running can be specified.	5-7	
Data register ROM backup	Initializes data registers with values backed up in ROM.	5-9	Special internal relays, Special data registers
High-speed counter	The high-speed counters can be used to count input pulses from rotary encoders or proximity switches regardless of the scan time.	5-13	Function area settings
Catch input	The catch input can be used to receive short pulses from sensors regardless of the scan time.	5-32	
Interrupt input	When a quick response to an external input is required, such as in positioning control, the interrupt input can call a subroutine to execute an interrupt program.	5-34	
Frequency measurement	The pulse frequency of input signals to input terminals can be counted regardless of the scan time.	5-36	
Input filter	The input filter rejects short input pulses when the SmartAXIS is used with input signals containing noises.	5-38	
Analog input	Analog voltage inputs, such as inputs from pressure sensors, can be read and stored in special data registers as digital values.	5-39	
Timer interrupt	When executing the same program repeatedly regardless of the scan time is required, the timer interrupt can call a subroutine at specified time interval.	5-41	
Forced I/O function	The inputs or outputs of the SmartAXIS can forcibly be turned on or off regardless of the actual inputs and outputs status.	5-43	Monitor
Communication ports	Communication mode and parameters for each communication port can be configured for the SmartAXIS to communicate with external devices.	5-46	Function area settings
Memory cartridge	The user program in a memory cartridge can be downloaded to the ROM in the SmartAXIS when the SmartAXIS is powered on.	5-49	Instructions/FB
SD memory card	DLOG and TRACE instructions/FBs can save the device values in CSV files and store those files in an SD memory card inserted to the SmartAXIS.	5-52	Function area settings
Backlight ON Time	SmartAXIS Pro LCD backlight on time setting	5-57	
Monitoring Ladder Program	Settings for running the ladder program monitor on the SmartAXIS Pro LCD	5-58	
Message Settings	Common settings for messages displayed on the SmartAXIS Pro LCD with the MSG instruction/FB	5-60	
32-bit data storage setting	The order of upper and lower words for 32-bit data can be specified.	5-62	
User program protection	The user program in the SmartAXIS can be protected with a password against the user program upload or download.	5-64	Special data registers
Watchdog timer settings	The watchdog timer monitors the SmartAXIS operation and the watchdog time preset value can be changed.	5-66	
Constant scan time	The scan time of the SmartAXIS can be made constant by specifying the constant scan time.	5-67	
Daylight savings time	The internal clock of the SmartAXIS can automatically be adjusted according to the configured daylight saving time period.	5-68	Function area settings
Clock function	The SmartAXIS can operate according to the current date and time and be used in applications, such as lighting or air conditioning.	5-69	Instructions/FB
Network settings	Configuring the network settings of the SmartAXIS is required to connect the SmartAXIS to the network.	5-72	Function area settings
Connection settings	Communication mode and parameters for the Ethernet communication can be configured for each connection so that the SmartAXIS can communicate with other network devices over the Ethernet.	5-73	
Remote host list	The remote host devices on the network that the SmartAXIS communicates with can be registered and managed in the Remote Host List.	5-75	

Function Area Settings

Various special functions of the SmartAXIS are configured in the Function Area Settings of WindLDR PLC programming software.

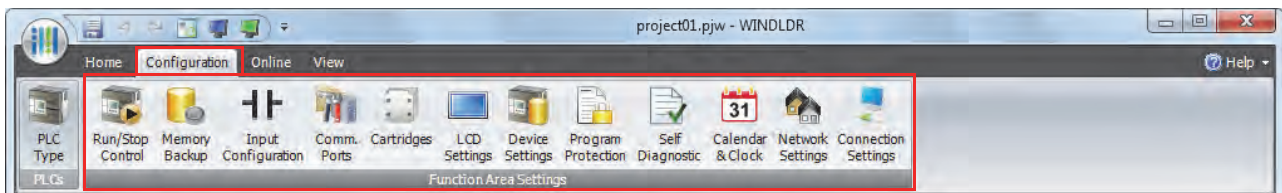

From the WindLDR menu bar, select **Configuration > Run/Stop Control**.

The Function Area Settings dialog box is displayed.

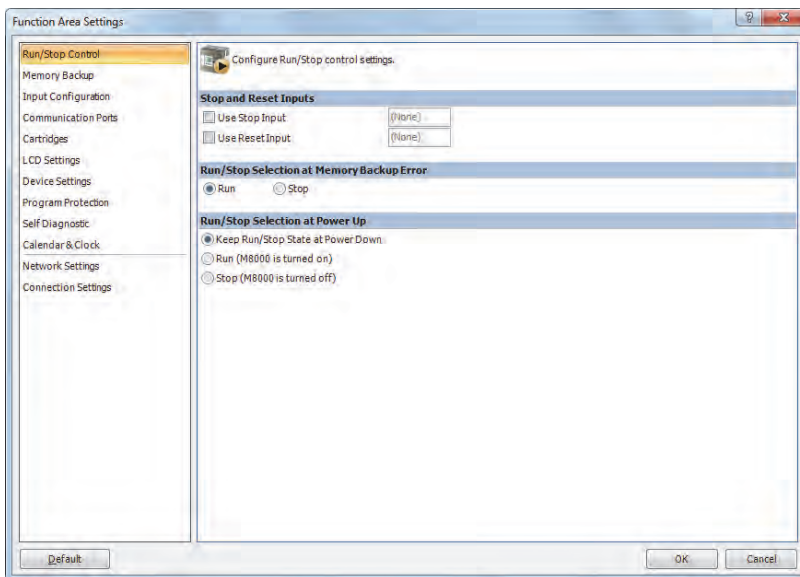

Function Description

- | | |
|---------------------|--|
| Run/Stop Control | <p>Configure the following run/stop control settings.</p> <ul style="list-style-type: none"> • Stop input • Reset input • Run/stop selection at memory backup error • Run/stop selection at power up |
| Memory Backup | <p>When the SmartAXIS starts running, device values in the RAM are kept or cleared. Configure the keep/clear settings for the following devices.</p> <ul style="list-style-type: none"> • Internal relays • Shift registers • Counters • Data registers |
| Input Configuration | <p>Configure the inputs to use special functions, such as the input filters or high-speed counters.</p> <ul style="list-style-type: none"> • High-speed counter • Catch input • Interrupt input • Frequency measurement • Input filter • Analog input • Timer interrupt |

Communication Ports	Configure the communication ports for the SmartAXIS to communicate with external devices equipped with RS232C or RS485 ports. <ul style="list-style-type: none">• Maintenance communication• User communication• Modbus RTU master/slave
Cartridges	Downloads the user program in a memory cartridge to the SmartAXIS module's ROM.
LCD Settings	Configure the LCD settings for the SmartAXIS. <ul style="list-style-type: none">• Backlight ON Time• Monitoring Ladder Program• Message Settings
Device Settings	Configure the order to store the upper and lower words for 32-bit data.
Program Protection	Applies the protection to the user program by configuring a password so unauthorized users cannot inadvertently upload or download it.
Self Diagnostic	Configure the watchdog timer monitoring the operating status of the SmartAXIS.
Calendar & Clock	The SmartAXIS is equipped with an internal clock and its calendar data (year, month, day, day of the week) and clock data (hour, minute, second) can be used in user programs. Daylight savings time can also be configured for the internal clock.
Network Settings	Configure the network settings to connect the SmartAXIS to the network using the Ethernet port.
Connection Settings	Configure server/client communication used by the SmartAXIS Ethernet port. <ul style="list-style-type: none">• Maintenance communication server• User communication server/client• Modbus TCP communication server/client• Remote I/O master

Stop Input and Reset Input

As described on "Start/Stop Operation" on page 4-17, the SmartAXIS can be started and stopped using a stop input or reset input, which can be designated from the Function Area Settings menu. When the designated stop or reset input is turned on, the SmartAXIS stops operation. For the system statuses in the stop and reset modes, see "Start/Stop Operation Using the Power Supply" on page 4-18.

Since these settings relate to the user program, the user program must be downloaded to the SmartAXIS after changing any of these settings.

Programming WindLDR

1. From the WindLDR menu bar, select **Configuration > Run/Stop Control**.
The Function Area Settings dialog box for Run/Stop Control appears.

2. Click the check box under the Stop and Reset Inputs.

Stop Input: Click the check box on the left of Use Stop Input and type a desired input number available on the SmartAXIS in the Stop Input field.

Reset Input: Click the check box on the left of Use Reset Input and type a desired reset number available on the SmartAXIS in the Reset Input field.

This example designates input I0 as a stop input and input I1 as a reset input.

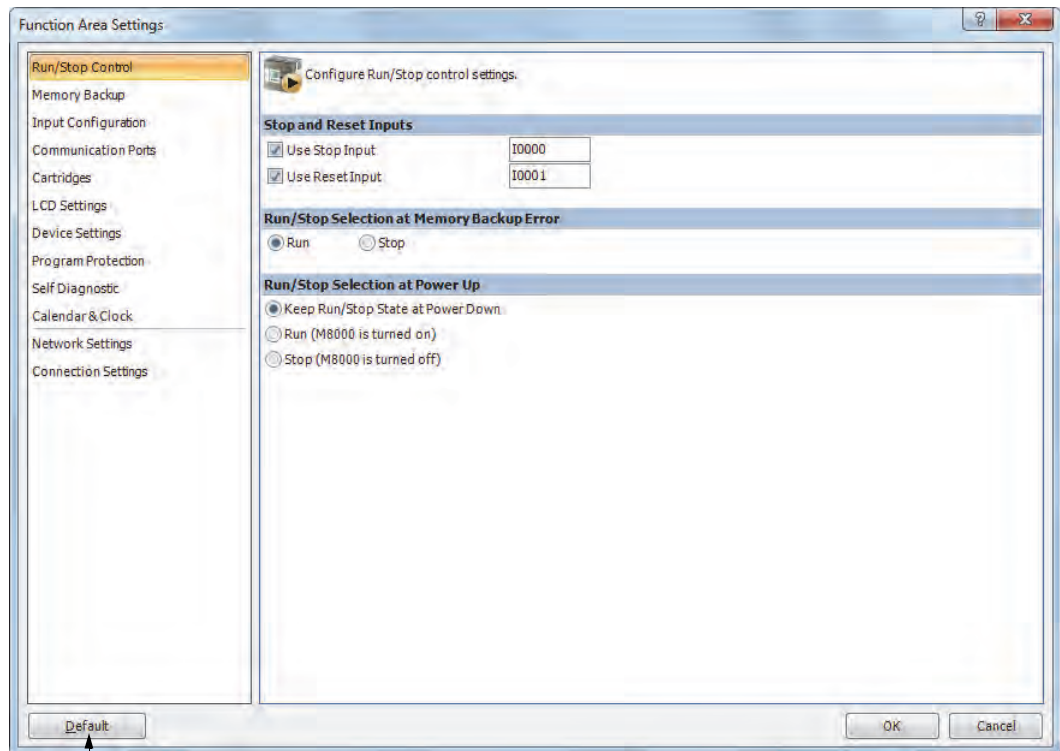

Resets all Function Area Settings values to defaults.

Default: No stop and reset inputs are designated.

3. Click the **OK** button.

Run/Stop Selection at Memory Backup Error

Start control special internal relay M8000 maintains its status when the SmartAXIS is powered down. After the SmartAXIS has been off for a period longer than the battery backup duration, the data designated to be maintained during power failure is lost. The Run/Stop Selection at Memory Backup Error dialog box is used to select whether to start or stop the SmartAXIS when attempting to restart operation after the “keep” data in the SmartAXIS RAM has been lost.

When memory backup error occurs, Run/Stop Selection at Memory Backup Error is more preferred than Run/Stop Selection at Power Up.

When a built-in lithium battery is fully charged, data of internal relays, shift registers, counters, and data registers stored in the RAM are maintained for approximately 30 days.

Since this setting relates to the user program, the user program must be downloaded to the SmartAXIS after changing this setting.

Programming WindLDR

1. From the WindLDR menu bar, select **Configuration > Run/Stop Control**.

The Function Area Settings dialog box for Run/Stop Control appears.

2. Click the **Run** or **Stop** button.

Run (Default): Click the button on the left to start the SmartAXIS at memory backup error.

Stop: Click the button on the right to stop the SmartAXIS when attempting to start at memory backup error. When the SmartAXIS does not start because of the Stop selection, the SmartAXIS cannot be started alone, then the SmartAXIS can still be started by sending a start command from WindLDR to turn on start control special internal relay M8000. For start/stop operation, see “Start/Stop Operation” on page 4-17.

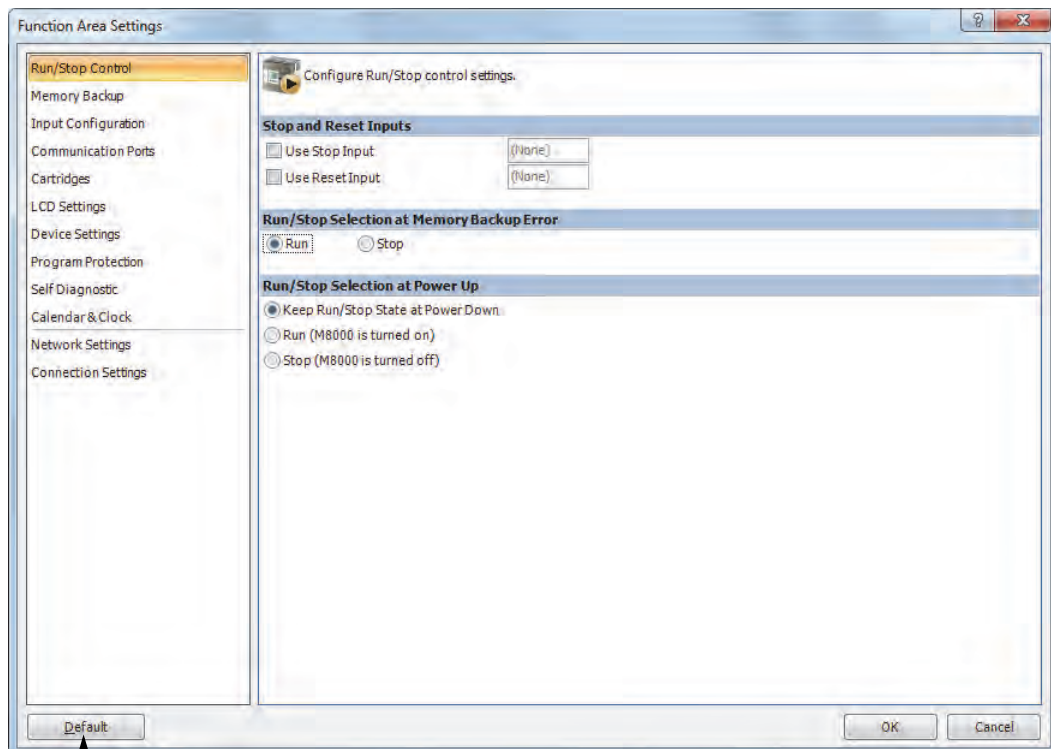

Resets all Function Area Settings values to defaults.

3. Click the **OK** button.

Run/Stop Selection at Power Up

Start control special internal relay M8000 maintains its status when the SmartAXIS is powered down. When powered up, the SmartAXIS is started or stopped according to the M8000 status. The Run/Stop Selection at Power Up is used to select whether to start or stop the SmartAXIS regardless of the M8000 status when the SmartAXIS is powered up.

When a memory cartridge is installed on a SmartAXIS, the SmartAXIS is started or stopped according to the M8000 status of the SmartAXIS. The SmartAXIS can always be started regardless of the M8000 status by using Run/Stop Selection at Power Up. WindLDR software is not needed to start the SmartAXIS.

Stop and Reset inputs have priority over start control special internal relay M8000. When the memory backup error occurs, the SmartAXIS is started or stopped according to Run/Stop Selection at Memory Backup Error regardless of Run/Stop Selection at Power Up. For start/stop operation, see "Start/Stop Operation" on page 4-17.

Since this settings relate to the user program, the user program must be downloaded to the SmartAXIS after changing this settings.

Programming WindLDR

1. From the WindLDR menu bar, select **Configuration > Run/Stop Control**.
The Function Area Settings dialog box for Run/Stop Control appears.

2. Click the button under Run/Stop Selection at Power Up.

Keep Run/Stop State at Power Down (Default):

Click this button to keep the run/stop status at power down when the SmartAXIS is powered up.

Run (M8000 is turned on):

Click this button to always start the SmartAXIS when the SmartAXIS is powered up.

Stop (M8000 is turned off):

Click this button to always stop the SmartAXIS when the SmartAXIS is powered up.

This example designates Keep Run/Stop Status at Power Down.

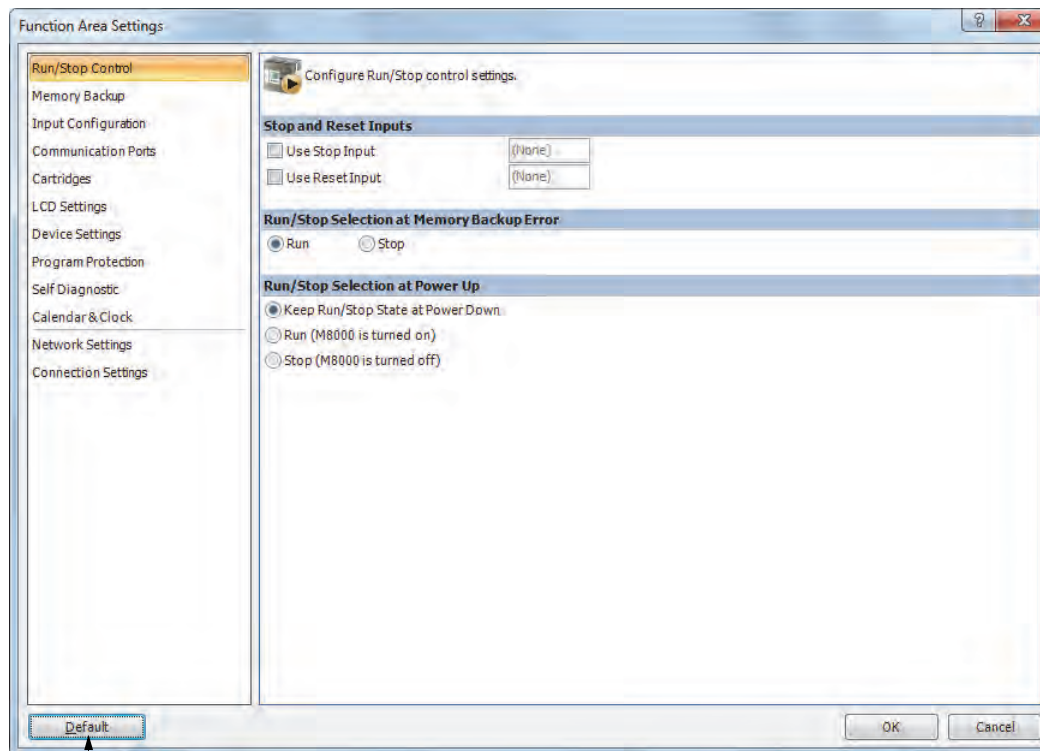

Resets all Function Area Settings values to defaults.

3. Click the **OK** button.

Keep Designation for Internal Relays, Shift Registers, Counters, and Data Registers

The statuses of internal relays and shift register bits are usually cleared at startup. It is also possible to designate all or a block of consecutive internal relays or shift register bits as “keep” types. Counter current values and data register values are usually maintained at powerup. It is also possible to designate all or a block of consecutive counters and data registers as “clear” types. When the SmartAXIS is stopped, these statuses and values are maintained. When the SmartAXIS is reset by turning on a designated reset input, these statuses and values are cleared despite the settings in the Configure Keep/Clear Settings dialog box shown below. The keep/clear settings in this dialog box are not maintained when restarting the SmartAXIS.

Since these settings relate to the user program, the user program must be downloaded to the SmartAXIS after changing any of these settings.

Programming WindLDR

1. From the WindLDR menu bar, select **Configuration > Memory Backup**.
The Function Area Settings dialog box for Configure Keep/Clear Settings appears.
2. Click the buttons under Internal Relay, Shift Register, Counter, and Data Register to clear all, keep all, or keep/clear specified range as required.

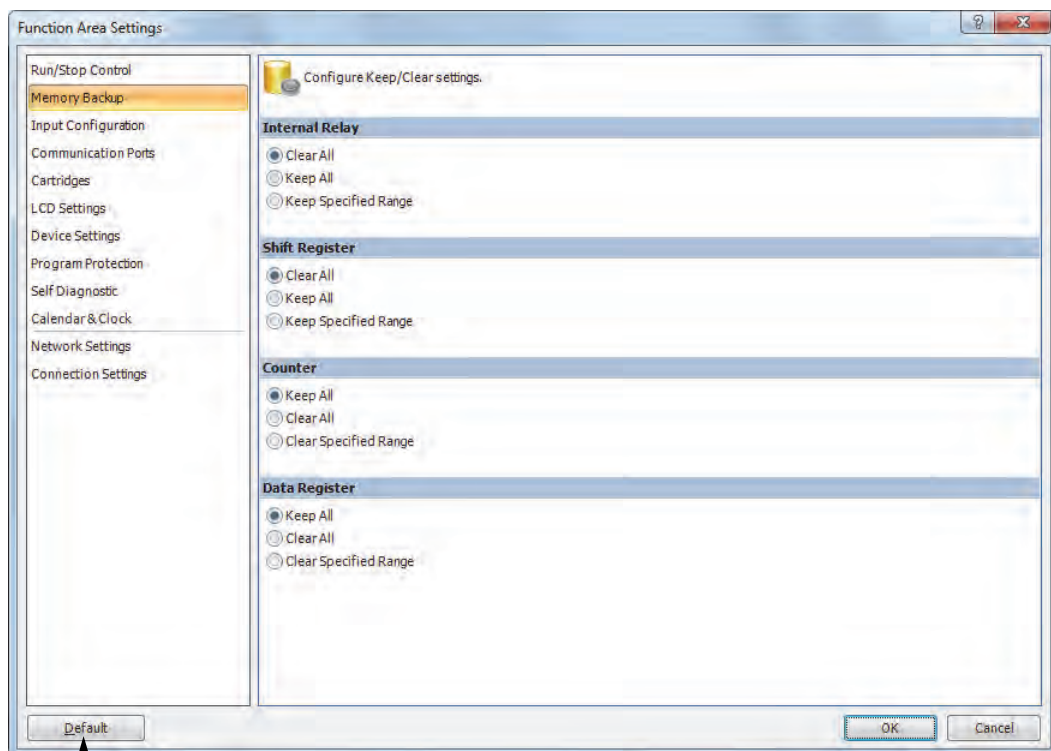

Resets all Function Area Settings values to defaults.

5: SPECIAL FUNCTIONS

Internal Relay 'Keep' Designation

- Clear All:** All internal relay statuses are cleared at startup (default).
- Keep All:** All internal relay statuses are maintained at startup.
- Keep Specified Range:** A specified range of internal relays are maintained at startup. Enter the start "keep" number in the left field and the end "keep" number in the right field. The start "keep" number must be smaller than or equal to the end "keep" number.
- Valid internal relay numbers are M0 through M1277. Special internal relays cannot be designated.

Internal Relay

Clear All

Keep All

Keep Specified Range

Start Keep Number through End Keep Number (≥ Start Keep Number)

When a range of M50 through M100 is designated as shown in the example above, M50 through M100 are keep types, M0 through M47 and M101 through M1277 are clear types.

Shift Register 'Keep' Designation

- Clear All:** All shift register bit statuses are cleared at startup (default).
- Keep All:** All shift register bit statuses are maintained at startup.
- Keep Specified Range:** A specified range of shift register bits are maintained at startup. Enter the start "keep" number in the left field and the end "keep" number in the right field. The start "keep" number must be smaller than or equal to the end "keep" number.
- Valid shift register bit numbers are R0 through R127.
- When a range of R17 through R32 is designated, R17 through R32 are keep types, R0 through R16 and R33 through R127 are clear types.

Counter 'Clear' Designation

- Keep All:** All counter current values are maintained at startup (default).
- Clear All:** All counter current values are cleared at startup.
- Clear Specified Range:** A specified range of counter current values are cleared at startup. Enter the start "clear" number in the left field and the end "clear" number in the right field. The start "clear" number must be smaller than or equal to the end "clear" number.
- Valid counter numbers are C0 through C199.
- When a range of C0 through C10 is designated, C0 through C10 are clear types, and C11 through C199 are keep types.

Data Register 'Clear' Designation

- Keep All:** All data register values are maintained at startup (default).
- Clear All:** All data register values are cleared at startup.
- Clear Specified Range:** A specified range of data register values are cleared at startup. Enter the start "clear" number in the left field and the end "clear" number in the right field. The start "clear" number must be smaller than or equal to the end "clear" number.
- Valid data register numbers are D0 through D1999. Special data registers cannot be designated.
- When a range of D100 through D1999 is designated, D0 through D99 are keep types, and D100 through D1999 are clear types.

For the range of data registers that support the keep designation, see Chapter 7 "Device Addresses" - "Device Addresses" on page 7-1.

Notes:

- Relays and registers specified as **Clear All** or **Clear Specified Range** are cleared when the SmartAXIS starts operation. The values while the power is off are retained until the power is turned on and operation is started.
- Keep/clear settings cannot be configured for special data registers. They operate the same as **Clear All**.
- Keep/clear settings cannot be configured for special internal relays. For operation when the power is shut off and when stopped, see Chapter 7 "Device Addresses" - "Special Internal Relays" on page 7-2.

Data Register ROM Backup

This section describes data register ROM backup.

Data Register ROM Backup Overview

Data register ROM backup is a function to write data register values to ROM (non-volatile memory), and then read the values in ROM and store them in data registers at the desired timing. The SmartAXIS stores the device values using an internal backup battery (lithium secondary battery). However, if the backup battery is dead due to a long term power loss, a memory backup error will occur and the device values will be lost. In this situation, if you use data register ROM backup, you can initialize the data registers with the values backed up in ROM. When a memory cartridge is installed, data is written to and read from the memory cartridge.*1

*1 When you use the Lite and a memory cartridge is not installed on the Lite, data register ROM backup cannot be used.

■ Applicable data registers

The applicable data registers are as follows.

Model number	12-I/O type	24-, 40-, 48-I/O types
Data registers	D0000 to D0399	D0000 to D1999

■ ROM region

The ROM region that is used is as follows.

		Memory cartridge	
		Not installed	Installed
Model name	Pro	Pro	Memory cartridge
	Lite	None (The data register ROM backup cannot be used.)	Memory cartridge

■ Special devices

Special internal relays

Device	Description
M8154	When M8154 is on at the end of scan, the values of all data registers are written to ROM. After all values are written, the execution status is stored in D8133 and M8154 turns off.
M8155	When M8155 is on at the end of scan, the values in the corresponding ROM are read and stored to the data registers specified by D8184 (starting address to read) and D8185 (number of registers to read). After all values are read, the execution status is stored in D8133 and M8155 turns off.

Special data registers

Device	Description
D8133	Stores the execution status for writing and reading. 1: Processing 2: Normal termination 3: Cannot access ROM The following are possible causes: <ul style="list-style-type: none"> • The memory cartridge is not properly installed. • The ROM of Pro or the memory cartridge installed has failure. • On the Lite, reading or writing is executed when the memory cartridge is not installed. 4: Invalid values are stored in D8184 (starting address to read) and D8185 (number of registers to read) This error occurs when reading values. The following are possible causes: <ul style="list-style-type: none"> • The number of registers to read is 0. • The start address to read exceeds the largest data register address. • The start address to read + the number of registers to read exceeds the largest data register address. 5: Valid data could not be read from ROM This error occurs when reading. The following are possible causes: <ul style="list-style-type: none"> • No values are stored in the ROM. • Writing values did not finish for a reason such as the power was turned off while writing values.
D8184	Stores the start address of the data registers to read. The value that can be specified is 0 to 399 for the 12-I/O type and 0 to 1999 for the 24-, 40-, 48-I/O types.
D8185	Stores the number of data registers to read. The value that can be specified is 1 to 400 for the 12-I/O type and 1 to 2000 for the 24-, 40-, 48-I/O types.

Note: When M8154 and M8155 are on in the scan end, writing and reading are executed in that order. After executing the read, the execution status is stored in D8133, and M8154 and M8155 turn off.

Function Description

Writing the data register values to ROM

When M8154 is on at the end of scan, the values of all of the data registers are written to ROM. After writing values, the execution status is stored in D8133 and M8154 turns off.

Example: 12-I/O model

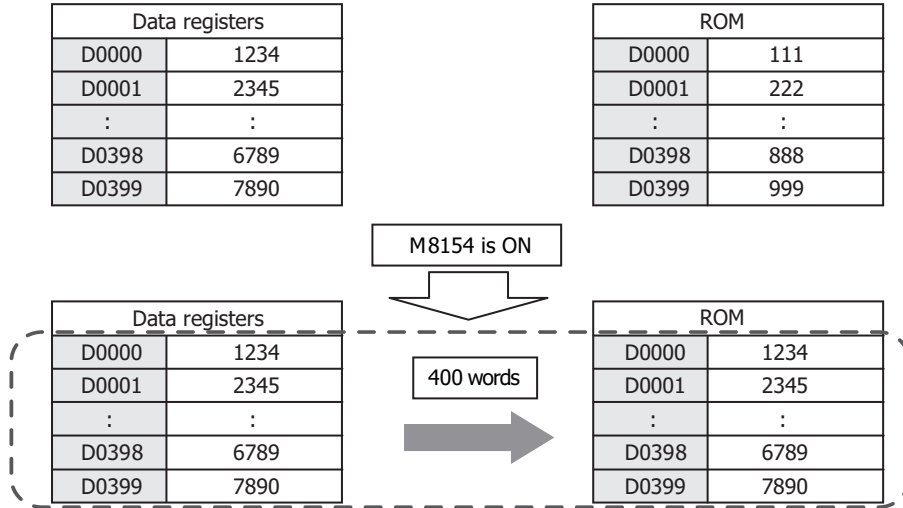

Example: 24-, 40-, 48-I/O model

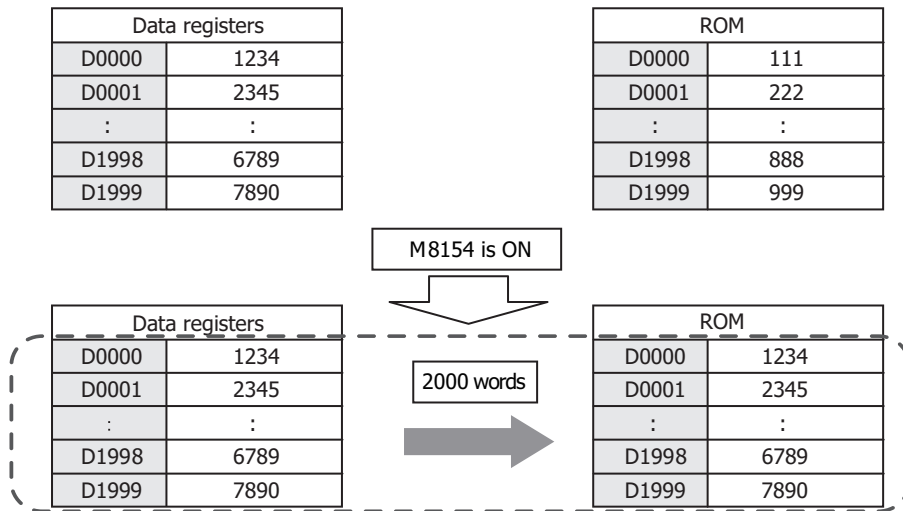

Reading the data register values from ROM

When M8155 turns on at the end of scan, the values in the corresponding ROM are read and stored in the data registers specified by D8184 (start address to read) and D8185 (number of registers to read). After reading values, the execution status is stored in D8133 and M8155 turns off.

Example 1: When reading the values of D0100 to D0179 (80 words) with a 12-I/O model, specify D8184=(100) and D8185=(80), and then turn on M8155.

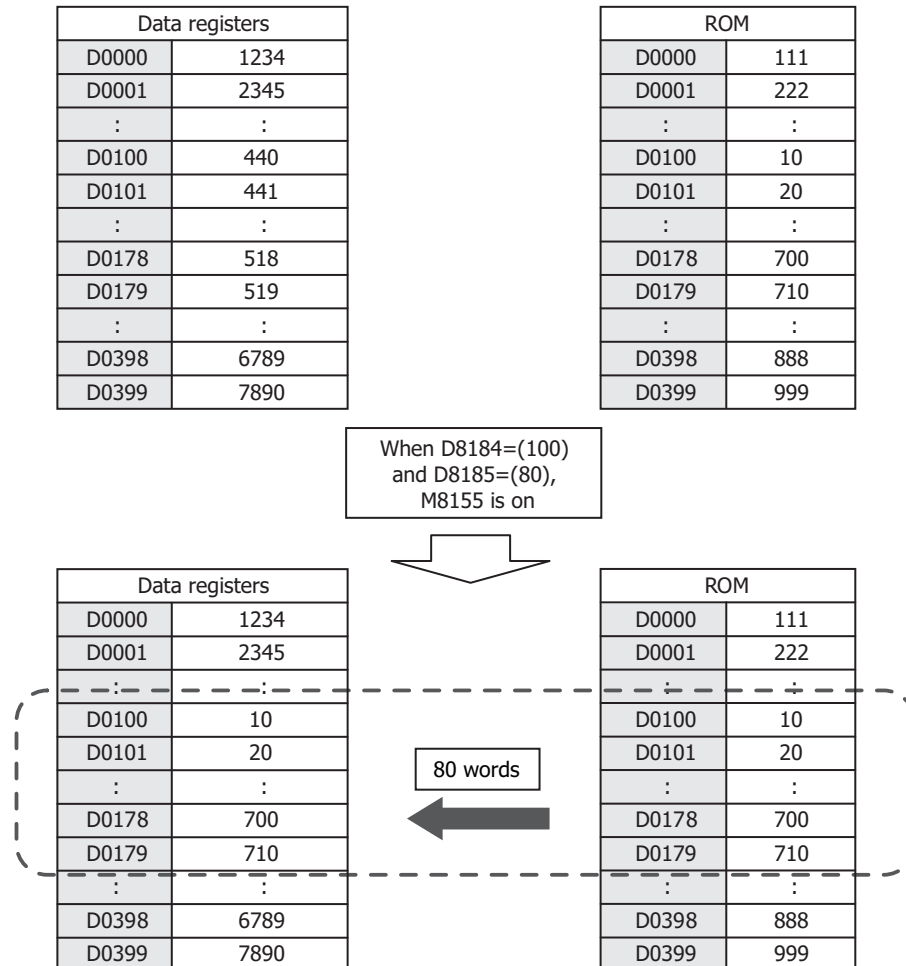

5: SPECIAL FUNCTIONS

Example 2: When reading the values of D0800 to D1499 (700 words) with a 24-/40-/48-I/O model, specify D8184=(800) and D8185=(700), and then turn on M8155.

Data registers	
D0000	1234
D0001	2345
:	:
D0800	440
D0801	441
:	:
D1498	518
D1499	519
:	:
D1998	6789
D1999	7890

ROM	
D0000	111
D0001	222
:	:
D0800	10
D0801	20
:	:
D1498	700
D1499	710
:	:
D1998	888
D1999	999

When D8184=(800)
and D8185=(700),
M8155 is on

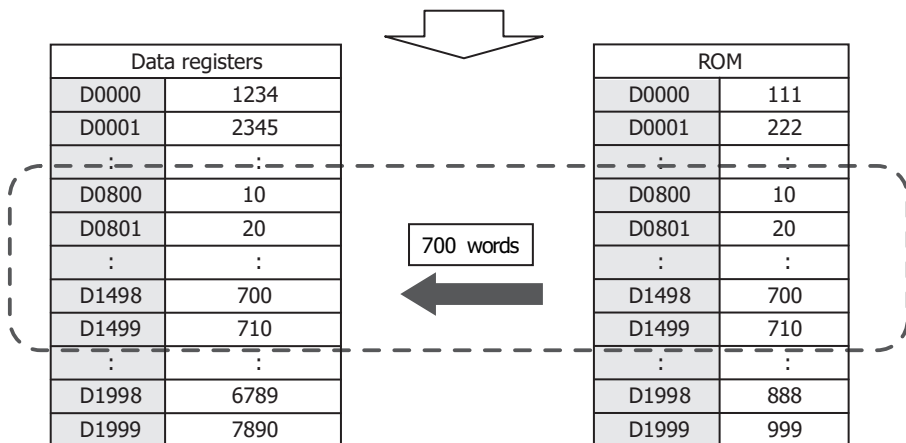

High-Speed Counter

This section describes the high-speed counter for counting high-speed pulses from devices such as rotary encoders and proximity switches. The high-speed counter is a function that counts high-speed pulses with the SmartAXIS hardware that cannot be read in the execution of a normal user program. The high-speed counter has a comparator function to compare the current value and a preset value (target value). When the current value and the preset value match, an external output is turned on or an interrupt program is executed. However, the interrupt program can only be used when ladder program is selected as the programming language.

The high-speed counter has a single-phase high-speed counter and a two-phase high-speed counter.

For the ladder program, to use the high-speed counter, the WindLDR function area settings, data registers, special internal relays, and special data registers must be configured.

For the FBD program, WindLDR function area settings and high-speed counter (HSC) function block settings are required. For details on the HSC function block, see Chapter 18 "The special FB" - "HSC (High-speed Counter)" in the "SmartAXIS FBD Programming Manual".

The AC power type does not support the high-speed counter. In situations where the high-speed counter function is required, use the DC power type.

• Application example

This application example punches holes into a roll of paper at a regular interval. The two pulses (A-phase, B-phase) that carry the phase difference output from the rotary encoder are counted by the SmartAXIS two-phase high-speed counter.

When the current value reaches the preset value, the specified external output turns on and the perforator punches a hole in the roll of paper.

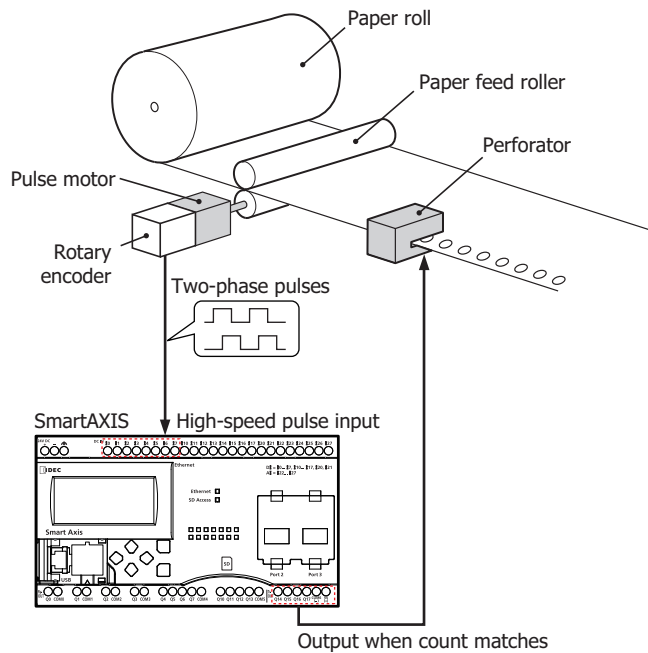

High-speed counter operation modes

The high-speed counter has the following two operation modes:

- Single-phase high-speed counter
- Two-phase high-speed counter

High-speed counting modes

The high-speed counter has the following four counting modes:

- Adding counter (single-phase high-speed counter)
- Up/down selection reversible counter (single-phase high-speed counter)
- 2-edge count (two-phase high-speed counter)
- 4-edge count (two-phase high-speed counter)

Example: The input allocation when external input group 1 is specified as a two-phase high-speed counter

External input	I0	I1	I2
	↓	↓	↓
High-speed counter	A-phase	B-phase	External clear input (Z-phase)

High-speed Counter External Inputs

The SmartAXIS can use a maximum of six single-phase high-speed counters and a maximum of two two-phase high-speed counters. The 12-I/O type can only use a maximum of four single-phase high-speed counters and a maximum of two dual-phase high-speed counters.

Single-phase high-speed counter

The 24-, 40-, and 48-I/O types can use external inputs I6 and I7 as single-phase the high-speed counters.

The 12-I/O type cannot use external inputs I6 and I7 as single-phase high-speed counters. External inputs I6 and I7 are normal inputs.

Group	1		2	3		4	5	6
External input	I0	I1	I2	I3	I4	I5	I6	I7
Single-phase high-speed counter	Pulse input	Up/down selection input (Note)	Pulse input/ external clear input	Pulse input	Up/down selection input (Note)	Pulse input/ external clear input	Pulse input	Pulse input

Note: Can only be used when the counting mode is specified as the up/down selection reversible counter.

Two-phase high-speed counter

External inputs I0/I1 (group 1) and I3/I4 (group 3) can be used as two-phase high-speed counters. External inputs I2 and I5 can be used as external clear inputs for group 1 and group 3. In this situation, external inputs I2 and I5 cannot be used as single-phase high-speed counters.

Group	1		2	3		4	5	6
External input	I0	I1	I2	I3	I4	I5	I6	I7
Two-phase high-speed counter	Pulse input (A-phase)	Pulse input (B-phase)	External clear input (Note) (Z-phase)	Pulse input (A-phase)	Pulse input (B-phase)	External clear input (Note) (Z-phase)	—	—

Note: If not used as the external clear input (Z-phase), group 2 and group 4 can be used as single-phase high-speed counters.

High-Speed Counter Operation

The high-speed counter turns on an external output or executes an interrupt program when the current value matches the preset value (target value).

The high-speed counter has two operation modes, the adding counter and the up/down selection reversible counter.

For how to configure the function to turn on an external output, see "Comparison Actions" on page 5-17.

• Single-phase high-speed counter

Group 1, group 3 single-phase high-speed counter

- These groups support the adding counter and the up/down selection reversible counter that can count both up and down.
- These groups support 100 kHz maximum pulse input and are capable of counting in a range from 0 to 4,294,967,295 (32 bits).
- When the current value and the preset value match or an overflow or underflow occurs, a comparison output turns on or an interrupt program is executed.
- These groups support resetting the current value by the reset special internal relay or external clear input. When the reset is executed, the current value returns to the reset value specified by the special data registers. For the reset input details, see "Reset input" on page 5-24.

Counting mode	Frequency
Adding counter	Group 1, 3: 100 kHz
Up/down selection reversible counter	Group 1: 100 kHz Group 3: 50 kHz

Group 2, group 4, group 5, group 6 single-phase high-speed counter

- These groups only support the adding counter.
- These groups support 100 kHz maximum pulse input and are capable of counting in a range from 0 to 4,294,967,295 (32 bits).
- When the current value and the preset value match or an overflow or underflow occurs, an external output turns on or an interrupt program is executed.
- These groups only support the reset input via a special internal relay. When the reset is executed, the current value returns to the reset value specified by the special data registers.

Counting mode	Frequency
Adding counter	Group 2, 4, 5, 6: 100 kHz

• Two-phase high-speed counter

Group 1, group 3 two-phase high-speed counter

- The two-phase high-speed counter counts by the phase difference between the A-phase and B-phase pulse input.
- These groups support 50 kHz maximum pulse input and are capable of counting in a range from 0 to 4,294,967,295 (32 bits).
- Even higher speed counting is possible by specifying 2-edge count or 4-edge count.
- When the current value and the preset value match or an overflow or underflow occurs, an external output turns on or an interrupt program is executed.
- These groups support resetting the current value by the reset special internal relay or external clear input (Z-phase). When the reset is executed, the current value returns to the reset value specified by the special data registers.

Group	Frequency
Group 1	2-edge count: 50 kHz
	4-edge count: 25 kHz
Group 3	2-edge count: 25 kHz
	4-edge count: 12.5 kHz

Counting mode

The high-speed counter as the following four counting modes.

• **Adding counter (single-phase high-speed counter)**

The adding counter counts up with the rise in pulse input.

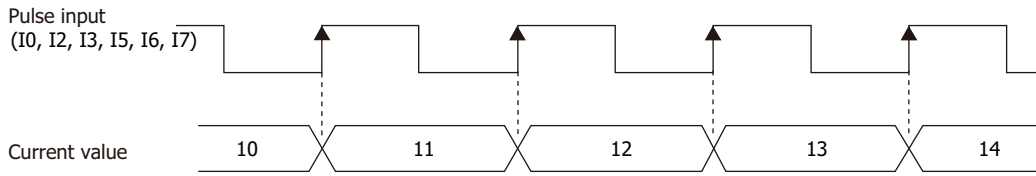

• **Up/down selection reversible counter (single-phase high-speed counter)**

Up/down selection reversible counter can switch between addition and subtraction by pulse input with the up/down selection input. When the up/down selection input is on, the counter counts up with the rise in pulse input. When the up/down selection input is off, the counter counts down with the rise in pulse input.

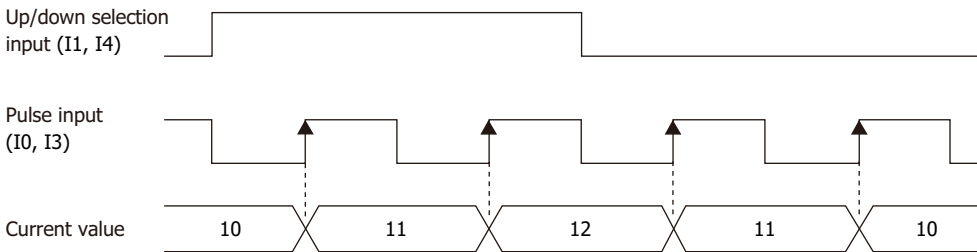

• **2-edge count (two-phase high-speed counter)**

This counter counts by the phase difference between the A-phase and B-phase pulse input. When the A-phase precedes the B-phase, the counter counts up with the rise and fall of the B-phase. When the B-phase precedes the A-phase, the counter counts down with the rise and fall of the B-phase.

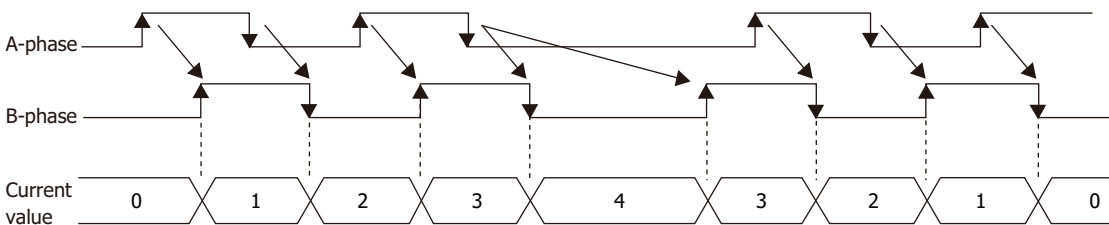

• **4-edge count (two-phase high-speed counter)**

This counter counts by the phase difference between the A-phase and B-phase pulse input. When the A-phase precedes the B-phase, the counter counts up with the rise and fall of the A-phase and the B-phase. When the B-phase precedes the A-phase, the counter counts down with the rise and fall of the A-phase and the B-phase.

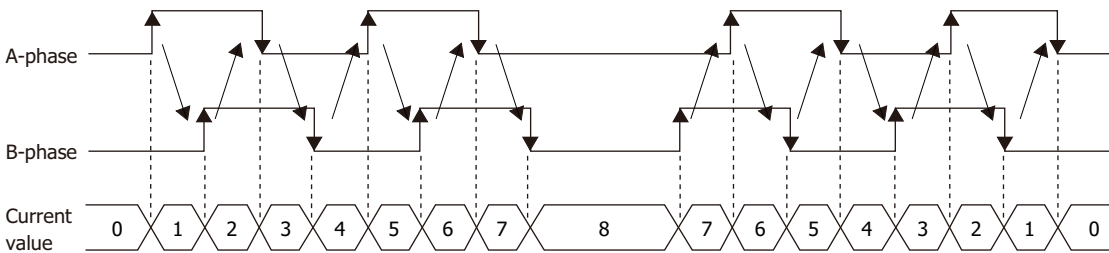

Comparison Actions

The operating condition when comparing values is configured in the WindLDR **High-speed Counter Settings**, under **Comparison Action**.

The action when comparing values is **Comparison Output** or **Interrupt Program**, so specify an external output number or label number when comparing. However, the interrupt program can only be used when ladder program is selected as the programming language.

Operation

When the preset value and the current value are compared and the values match, the specified output is turned on or the interrupt program is executed.

A maximum of six high-speed counter preset values can be configured. For one preset value, the current value is compared with the same preset value each time.

When multiple preset values are configured, the preset value is changed each time the current value and preset value match.

For example, if four preset values are configured, when preset value 1 matches the current value, the comparison subject changes to preset value 2 → 3 → 4 in order.

When the final preset value 4 matches the current value, the preset value returns to preset value 1 and the values are compared.

- Preset value storage locations**

The preset values during high-speed counter operation are stored as 2 words in special data registers.

Group	1 (10 to 11)	2 (12)	3 (13 to 14)	4 (15)	5 (16)	6 (17)	Read/Write
Preset Value (Upper word)	D8052	D8058	D8064	D8070	D8136	D8142	R
Preset Value (Lower word)	D8053	D8059	D8065	D8071	D8137	D8143	

Specify the data registers to store the preset values in WindLDR and store those preset values in the user program. Specify the start address of the data registers to allocate the data registers to the individual settings in the comparison settings. When the high-speed counter is executed, the preset value with the number stored in **Current Preset Value Number** is active. The active preset value number for each comparison is stored in **Current Preset Value Number** and the next active preset value number is automatically stored in **Next Preset Value Number**. By changing the value of **Next Preset Value Number** in the user program, the next active preset value number can be changed. The active preset value is stored for each group in the special data registers shown in the table above.

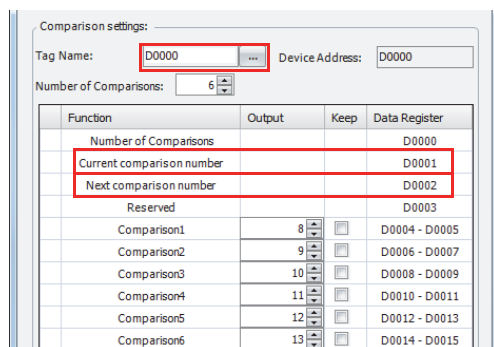

5: SPECIAL FUNCTIONS

Example: Group 1, number of preset values is 3, set to device address D0

When the current value matches preset value 1, **Current Preset Value Number** becomes 2 and 3 is stored in **Next Preset Value Number**.

When the device address is configured as D0, **Current Preset Value Number** is stored in D1 and **Next Preset Value Number** is stored in D2.

For the group 1 preset value, the value of the data registers (D4, D5) allocated to preset value number 1 is stored in D8052 and D8053 as shown in the table above and it is compared to the current value.

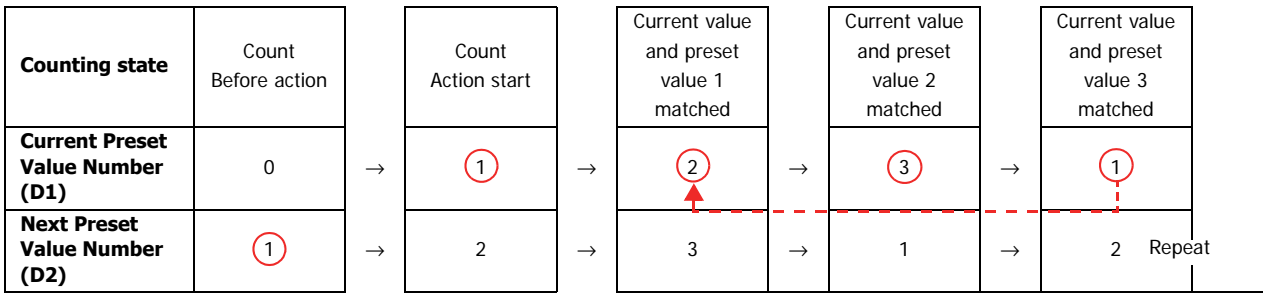

Before the count action, set the Next Preset Value Number and preset value 1 to 3 to the count values with the initialize pulse.

Preset value 1 is set to **Current Preset Value Number**

Preset value 2 is set.

Preset value 3 is set.

Once again, preset value 1 is set.

Note: When the **Next Preset Value Number** preset value becomes active, the high-speed counter preset value during execution does not change, even when the preset value for that preset value number is changed. When the current value and the current preset value match, the preset value with the number stored in **Next Preset Value Number** becomes active. Changes to the **Next Preset Value Number** data register must be performed before the preset value becomes active.

Comparison operation flow

The comparison operation flow is as follows.

1. Start (run) the SmartAXIS.

For the first scan, **Next Preset Value Number** is set to the number for preset value 1 with the initialize pulse.

For the second scan, an I/O refresh is performed in END processing and the value of **Next Preset Value Number** is transferred to **Current Preset Value Number**.

The content of **Next Preset Value Number** becomes the preset value n + 1 ("2" in this example).

When the number of preset values is 1, **Next Preset Value Number** is always "1".

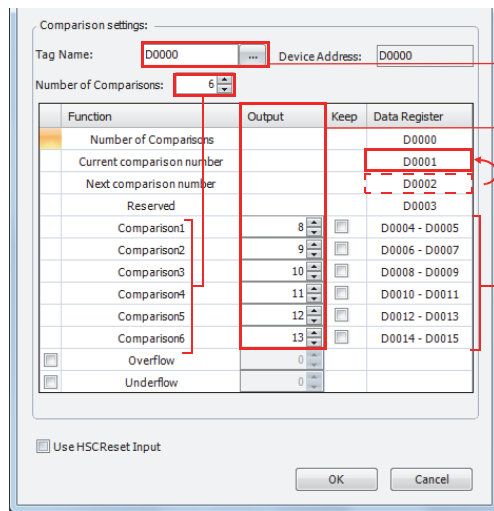

The data register that stores the preset value (target value). Specify the starting address.

The outputs (external outputs) when the values match.

Transfer

The preset value with the number that became active is the comparison subject with the current value and is stored in the special data registers.

Example: For group 1
Storage destination for the preset value that became active.
Stored by group.

Group	Group 1 (I0 to I1)	Read/Write
Preset Value (Upper word)	D8052	R/W
Preset Value (Lower word)	D8053	

2. Start the high-speed counter count operation.

Turn on the gate input to start the count operation.

3. Compare the **Current Preset Value Number** preset value and the current value. When the current value and the preset value match, the next number for the preset value becomes active and the high-speed counter continues counting.

Execute **Comparison Output** or **Interrupt Program**. (**Comparison Output** in this example)

- Turn on the comparison (special internal relay) for only one scan.
- Overwrite **Current Preset Value Number** with **Next Preset Value Number** and start the count with the preset value for **Current Preset Value Number**.
- Add 1 to **Next Preset Value Number**.

4. When the procedure is executed up to preset value 6, repeat again from the beginning with preset value 1.

Note: The **Current Preset Value Number** data register cannot be written to. It is read-only. **Next Preset Value Number** and **Preset Value 1** to **Preset Value 6** can be read and written to.

Programming WindLDR

To use the high-speed counter, a normal external input must be specified as **Two/Single-phase High-speed Counter** in the WindLDR **Function Area Settings**. The function for external inputs I0 to I7 on the SmartAXIS can be selected as normal input, high-speed counter, catch input, interrupt input, and frequency measurement.

When using normal input, catch input, interrupt input, or frequency measurement, the high-speed counter cannot be used. However, the interrupt program can only be used when ladder program is selected as the programming language.

1. From the WindLDR menu bar, select **Configuration > Input Configuration**.
The Function Area Settings dialog box is displayed.
2. Select **Two/Single-phase High-speed Counter** for the group to use the high-speed counter.

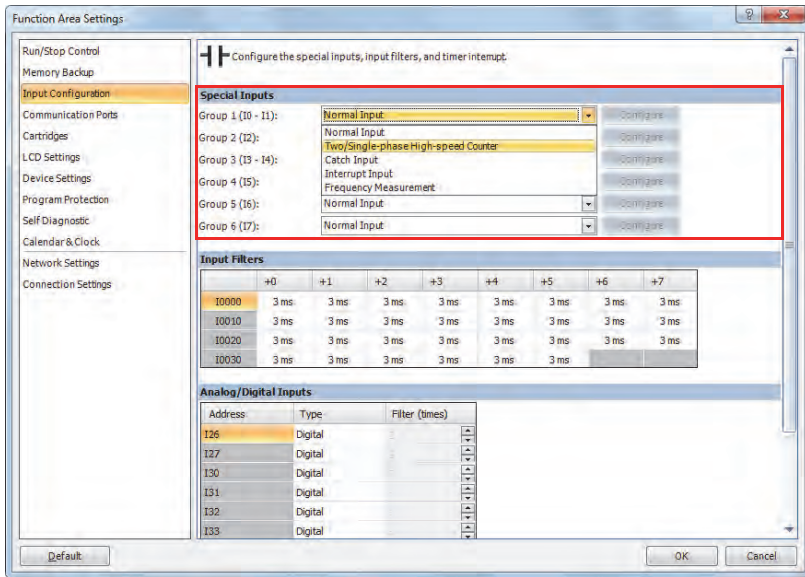

The High-speed Counter Settings dialog box is displayed.

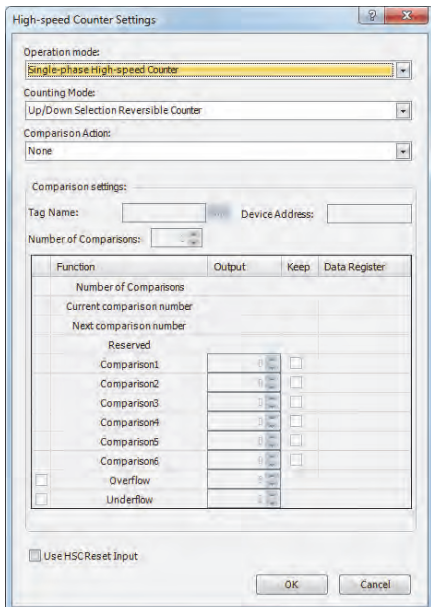

3. Configure the operation mode and the counting mode.
To use comparison actions, configure the comparison settings.
4. Click **OK**.
This concludes configuring the settings.

Settings

- **Operation mode**

For group 1 and group 3, you can select **Single-phase High-speed Counter** or **Two-phase High-speed Counter**.

When group 1 is selected as the high-speed counter, group 2 (I2) can be used as the external clear input.

When group 3 is selected as the high-speed counter, group 4 (I4) can be used as the external clear input.

The external inputs for group 2, group 4, group 5, and group 6 can only be used as single-phase high-speed counters.

- **Counting mode (single-phase high-speed counter)**

When the single-phase high-speed counter is specified for **Operation mode** for group 1 or group 3, the counting mode can be selected as **Adding counter** or **Up/down selection reversible counter**. The adding counter can only be used for the group 2, group 4, group 5, and group 6 high-speed counters.

Adding counter

The adding counter counts up with the rise in pulse input.

Up/down selection reversible counter

Up/down selection reversible counter can switch between addition and subtraction with the up/down selection input. When the up/down selection input is on, the counter counts up with the rise in pulse input. When the up/down selection input is off, the counter counts down with the rise in pulse input.

- **Counting mode (two-phase high-speed counter)**

When the two-phase high-speed counter is specified for **Operation mode** for group 1 or group 3, the counting mode can be selected as **2-edge count** or **4-edge count**. The two-phase counter cannot be used for the group 2, group 4, group 5, and group 6 high-speed counters.

2-edge count

This counter counts at double the frequency of the input pulse.

This counter counts by the phase difference between the A-phase and B-phase pulse input. When the A-phase precedes the B-phase, the counter counts up with the rise and fall of the B-phase. When the B-phase precedes the A-phase, the counter counts down with the rise and fall of the B-phase.

4-edge count

This counter counts at quadruple the frequency of the input pulse.

This counter counts by the phase difference between the A-phase and B-phase pulse input. When the A-phase precedes the B-phase, the counter counts up with the rise and fall of the A-phase and the B-phase. When the B-phase precedes the A-phase, the counter counts down with the rise and fall of the A-phase and the B-phase.

- **Comparison action**

The comparison action is a function that compares the high-speed counter's current value with a preset value (target value).

It can use either the comparison output or an interrupt program. However, the interrupt program can only be used when ladder program is selected as the programming language.

- When **Comparison Output** is selected, the specified external output is turned on when the current value and the preset value match.
- When **Interrupt Program** is selected, the subroutine program with the specified label number is executed as the interrupt program when the current value and the preset value match.

Overflow and underflow can also be used for the comparison conditions.

For details on the comparison actions, see "Comparison Actions" on page 5-17.

Comparison settings

When using the comparison output or the interrupt program as the comparison action for the high-speed counter, configure the external output number or the label number when there is a match. A maximum of six preset values can be specified for **Number of preset values** (preset value number 1 to 6).

Tag name

This setting specifies the starting address of the data register region to store the preset values.

Device address

This item shows the address of the data register specified by the tag name.

5: SPECIAL FUNCTIONS

Number of preset values

You can configure a maximum of six preset values (target values) for the comparison action.

Notes :

- The preset value becomes active by the END processing in the second scan after the SmartAXIS starts operation. Store **Preset Value** in the data registers with initialize pulse M8120 input.
- When the preset value (special data register) is changed before the comparison, the preset value currently being used for the comparison is discarded in the program's END processing, and the comparison is performed with the newly configured preset value.
- Configure the settings so that an interval of 1 ms or more is present between instances of the preset value and the current value matching. If this interval is less than 1 ms in length, the next Comparison ON status may be missed.

Output

When a comparison action is selected, these are the external outputs specified for preset value 1 to 6.

The external outputs that can be used as comparison outputs are listed by model as follows. Remote outputs cannot be configured.

Model number	Comparison output
12-I/O type	Q0 to Q3
24-I/O type	Q0 to Q7
40-I/O type	Q0 to Q7, Q10 to Q17
48-I/O type	Q0 to Q7, Q10 to Q17, Q20 to Q21

Overflow

Select this check box to use overflow in the comparison action conditions (when the current value exceeds 4,294,967,295).

Underflow

Select this check box to use underflow in the comparison action conditions (when the current value falls below 0).

Note: When the comparison action is **Comparison Output** and either a preset value, overflow, or underflow has been enabled as a comparison condition, the text box to enter the comparison output is enabled. The comparison output can be specified for each of these match conditions.

• Keep

After the current value matches the preset value, select to reset the current value to a reset value or to keep the value. Select this check box to keep the current value.

• Use HSC Reset Input

Select this check box to reset the current value to a reset value with external input (high-speed counter reset input).

High-speed counter reset input can only be specified for group 1 and group 3.

Group	External input
Group 1	I2
Group 3	I5

When the high-speed counter reset input is turned on, the current value is reset to a reset value.

If the high-speed counter reset input is not used, I2 and I5 are normal inputs.

High-speed counter devices

The high-speed counter operates according to special internal relay and special data register settings. While the high-speed counter is operating, the current value, control output, and operating status value are reflected in the special internal relays and special data registers with each scan.

The high-speed counter start and stop control signals and the current value, preset values, and reset values are allocated to the special internal relays and special data registers.

Device allocation table

The devices used by the high-speed counter are as follows.

Special internal relay list

Group	1 (I0 to I1)	2 (I2)	3 (I3 to I4)	4 (I5)	5 (I6)	6 (I7)	Read/Write
Comparison Output Reset	M8030	M8040	M8045	M8055	M8166	M8173	R/W
Gate Input	M8031	M8041	M8046	M8056	M8167	M8174	
Reset Input	M8032	M8042	M8047	M8057	M8170	M8175	
Reset Status	M8033	—	M8050	—	—	—	R
Comparison ON Status	M8034	M8043	M8051	M8060	M8171	M8176	
Overflow	M8035	M8044	M8052	M8061	M8172	M8177	
Underflow	M8036	—	M8053	—	—	—	
Count Direction flag	M8037	—	M8054	—	—	—	

Special data register list

Group	1 (I0 to I1)	2 (I2)	3 (I3 to I4)	4 (I5)	5 (I6)	6 (I7)	Read/Write
Current Value (Upper word)	D8050	D8056	D8062	D8068	D8134	D8140	R
Current Value (Lower word)	D8051	D8057	D8063	D8069	D8135	D8141	
Preset Value (Upper word)	D8052	D8058	D8064	D8070	D8136	D8142	R/W
Preset Value (Lower word)	D8053	D8059	D8065	D8071	D8137	D8143	
Reset Value (Upper word)	D8054	D8060	D8066	D8072	D8138	D8144	
Reset Value (Lower word)	D8055	D8061	D8067	D8073	D8139	D8145	

When using the devices above with instructions/FB where the data type unit can be specified, specify the data type as double word (D). When the 32-bit data storage setting in the function area settings is set to **From Lower Word**, the lower word is stored in the first device.

- **Start/stop high-speed counter**

The high-speed counter can be started and stopped per group by turning the gate input on or off.

Group	1 (I0 to I1)	2 (I2)	3 (I3 to I4)	4 (I5)	5 (I6)	6 (I7)	Read/Write
Gate Input	M8031	M8041	M8046	M8056	M8167	M8174	R/W

- **Current value storage locations**

The current value for the single-phase high-speed counter is stored in special data registers as 2 words per group.

Group	1 (I0 to I1)	2 (I2)	3 (I3 to I4)	4 (I5)	5 (I6)	6 (I7)	Read/Write
Current Value (Upper word)	D8050	D8056	D8062	D8068	D8134	D8140	R
Current Value (Lower word)	D8051	D8057	D8063	D8069	D8135	D8141	

When the 32-bit data storage setting in the function area settings is set to **From Lower Word**, the lower word is stored in the first device.

- **Comparison ON status**

When the current value and the preset value match, the special internal relay turns on for only one scan.

Group	1 (I0 to I1)	2 (I2)	3 (I3 to I4)	4 (I5)	5 (I6)	6 (I7)	Read/Write
Comparison ON Status	M8034	M8043	M8051	M8060	M8171	M8176	R

5: SPECIAL FUNCTIONS

• Overflow

When the current value exceeds 4,294,967,295, the special internal relay turns on for only one scan. When the current value overflows, it becomes 0.

Group	1 (10 to 11)	2 (12)	3 (13 to 14)	4 (15)	5 (16)	6 (17)	Read/Write
Overflow	M8035	M8044	M8052	M8061	M8172	M8177	R

• Underflow

When the current value falls below 0, the special internal relay turns on for only one scan. When the current value underflows, it becomes 4,294,967,295.

Group	1 (10 to 11)	2 (12)	3 (13 to 14)	4 (15)	5 (16)	6 (17)	Read/Write
Underflow	M8036	—	M8053	—	—	—	R

• Comparison output reset

When the special internal relay turns on, the comparison output selected on **High-speed Counter Settings** turns off.

Group	1 (10 to 11)	2 (12)	3 (13 to 14)	4 (15)	5 (16)	6 (17)	Read/Write
Comparison Output Reset	M8030	M8040	M8045	M8055	M8166	M8173	R/W

• Reset input

When reset input is turned on, the current value returns to the reset value.

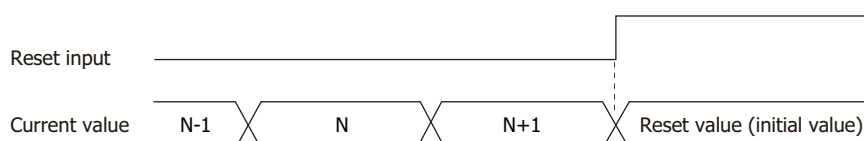

Group	1 (10 to 11)	2 (12)	3 (13 to 14)	4 (15)	5 (16)	6 (17)	Read/Write
Reset Input	M8032	M8042	M8047	M8057	M8170	M8175	R/W

• Preset value, reset value storage locations

The preset value and the reset value for the high-speed counter are stored in special data registers as 2 words.

Group	1 (10 to 11)	2 (12)	3 (13 to 14)	4 (15)	5 (16)	6 (17)	Read/Write
Preset Value (Upper word)	D8052	D8058	D8064	D8070	D8136	D8142	R/W
Preset Value (Lower word)	D8053	D8059	D8065	D8071	D8137	D8143	
Reset Value (Upper word)	D8054	D8060	D8066	D8072	D8138	D8144	
Reset Value (Lower word)	D8055	D8061	D8067	D8073	D8139	D8145	

When the 32-bit data storage setting in the function area settings is set to **From Lower Word**, the lower word is stored in the first device.

• **HSC reset input and reset status**

When the HSC reset input is enabled in group 1 or group 3, turn on HSC reset input I2 or I5 to return the current value to the reset value.

In this situation, reset status turns on for only one scan.

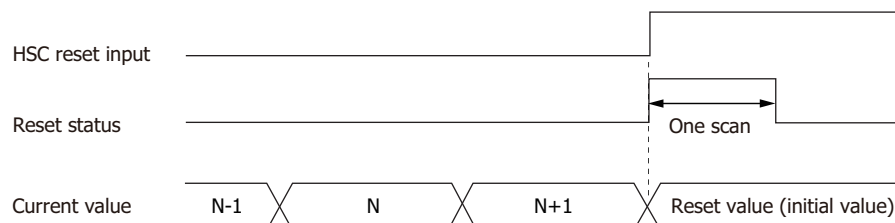

Group	1 (I0 to I1)	2 (I2)	3 (I3 to I4)	4 (I5)	5 (I6)	6 (I7)	Read/Write
HSC Reset Input	I2	—	I5	—	—	—	—
Reset Status	M8033	—	M8050	—	—	—	R

To use the reset input with the group 1 or group 3 single-phase high-speed counter, use I2 (group 2) or I5 (group 4). When not using I2 or I5 as a reset input, they can be used as normal input, high-speed counters, catch input, interrupt input, or frequency measurements.

• **Count direction flag**

These special internal relays maintain whether the group 1 or group 3 current value count is the adding direction or the subtracting direction. When these special internal relays are on, they indicate the adding direction. When they are off, they indicate the subtracting direction.

The flag operates as follows for each counting mode setting.

Counting mode		Count direction flag status	When the count direction flag changes
Single-phase high-speed counter	Adding counter	<ul style="list-style-type: none"> Always the adding direction 	<ul style="list-style-type: none"> None
	Up/down selection reversible counter	<ul style="list-style-type: none"> Adding direction when the up/down selection input is on. Subtracting direction when the up/down selection input is off. 	<ul style="list-style-type: none"> When the up/down selection input status has changed.
Two-phase high-speed counter	2-edge count / 4-edge count	<ul style="list-style-type: none"> Adding direction if the current value is incremented and reached to the preset value or the current value overflows in the previous comparison operation. Subtracting direction if the current value is decremented and reached to the preset value or the current value underflows in the previous comparison operation.^{*1} The default is the adding direction. 	<ul style="list-style-type: none"> When the current value and the preset value are equal. When a current value overflow or underflow has occurred.

*1 When operating as a two-phase high-speed counter, the count direction flag does not reflect the current adding/subtracting direction and indicates the adding/subtracting direction for the previous comparison.

Group	1 (I0 to I1)	2 (I2)	3 (I3 to I4)	4 (I5)	5 (I6)	6 (I7)	Read/Write
Count Direction flag	M8037	—	M8054	—	—	—	R

Timing chart 1

Single-phase high-speed counter (group 1) timing chart

Operating conditions

The counting mode is set to **Up/down selection reversible counter** and reset input (I2) is used.

One preset value is used, and when the values match, output Q1 turns on and the current value is kept.

Overflow and underflow are not used.

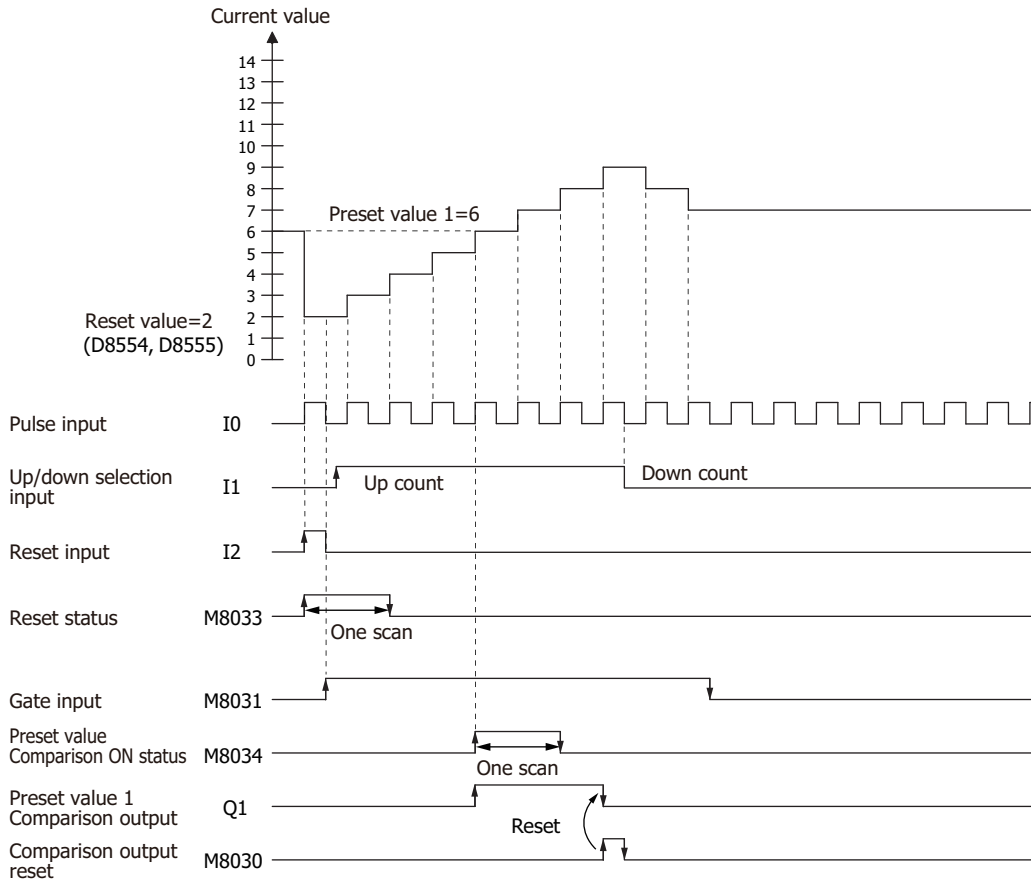

1. When reset input (I2) turns on, the reset value (D8054, D8055) is stored in the current value (D8050, D8051). In this situation, reset status (M8033) turns on for only one scan.
2. When gate input (M8031) turns on, the counting begins.
3. The counting direction (count up/count down) is determined by the on/off state of the up/down selection input (I1), and the pulse input (I0) is counted. The current value is updated with each scan.
4. When the current value and preset value 1 (D8052, D8053) match, the preset value 1 comparison output (Q1) and Comparison ON status (M8034) turn on. When the **Keep** check box is selected in the settings in the WindLDR **High-speed Counter Settings**, the current value is kept.
5. Q1 maintains the on state until comparison output reset (M8030) turns on. M8034 turns on for only one scan.
6. When the gate output turns off, counting stops.

Note: High-speed counter usage precautions

The high-speed counter starts the count operation with the following two conditions:

- The SmartAXIS starts operation
- The gate input is turned on

To start the count operation, turn the gate input on from off while the SmartAXIS is running. When the gate input is already on and the SmartAXIS is stopped, the count operation starts when the SmartAXIS is switched from stop to run.

When a user program is downloaded during the count operation, the count operation stops. The count operation will restart by setting the SmartAXIS to run.

Timing chart 2

Two-phase high-speed counter (group 1) timing chart

Operating conditions

The counting mode is set to **2-edge count** and reset input (I2) is used.

Two preset values are used, and when preset value 1 matches, output Q1 turns on and the current value is kept.

When preset value 2 matches, output Q2 turns on and the current value is cleared.

Overflow and underflow are not used.

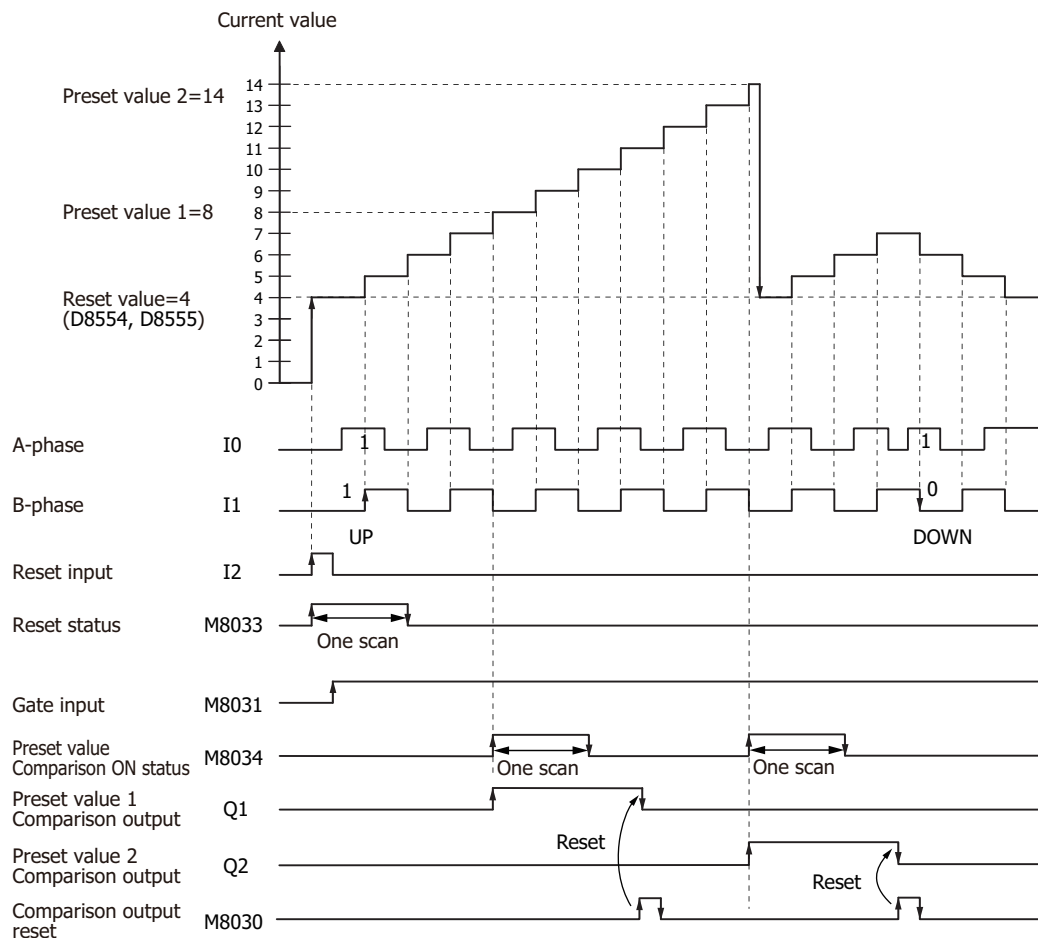

1. When reset input (I2) turns on, the reset value (D8054, D8055) is stored in the current value (D8050, D8051). In this situation, reset status (M8033) turns on for only one scan.
2. When gate input (M8031) turns on, the counting begins.
3. When the A-phase pulse (I0) precedes the B-phase pulse (I1), the count goes up. When the B-phase pulse (I1) precedes the A-phase pulse (I0), the count goes down.
4. When the current value and preset value 1 (D8052, D8053) match, the preset value 1 comparison output (Q1) and setting value match (M8034) turn on. When preset value 1 matches, preset value 2 is stored in the preset value (D8052, D8053) as the new preset value and counting continues.
5. The preset value 1 comparison output (Q1) maintains the on state until comparison output reset (M8030) turns on. M8034 turns on for only one scan.

5: SPECIAL FUNCTIONS

Example program 1

Using the single-phase high-speed counter on the ladder program, this example program turns on external output Q2 when 1000 pulses are counted.

Application description

When pulses are input to external input I0 and the count reaches 1000, external output Q2 is turned on.

In the WindLDR **Function Area Settings**, select **Two/Single-phase High-speed Counter** for **Group 1**.

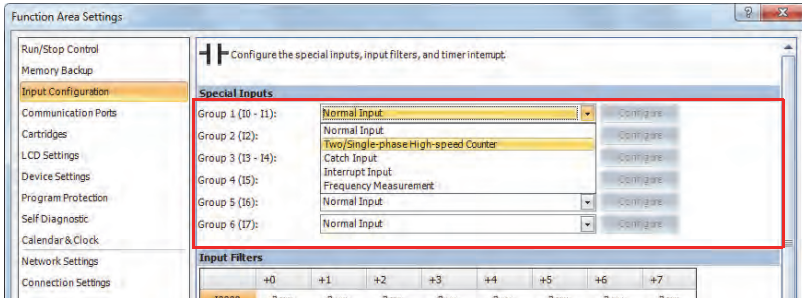

In **High-speed Counter Settings**, configure the settings as follows.

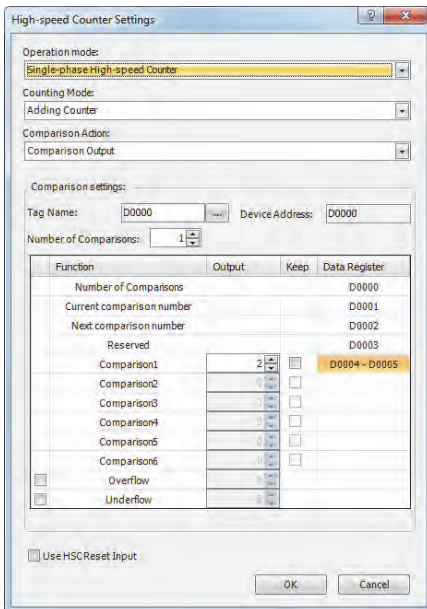

External input : Group 1 (I0 to I1)
 Operation mode : Single-phase High-speed Counter
 Counting Mode : Adding Counter
 Comparison Action : Comparison Output

Comparison settings

Tag name/device address : D0 (data register)
 Number of preset values : 1
 Comparison output : Q2 (external output when matched)
 Preset value 1 (D4) : 0 (upper word)
 Preset value 1 (D5) : 1,000 (lower word)
 Keep : Cleared
 Reset value (D8054) : 0 (upper word)
 Reset value (D8055) : 0 (lower word)
 Overflow : Cleared
 Underflow : Cleared
 Use HSC Reset Input : Cleared

Program

M8120 (initialize pulse) is a special internal relay that turns on when the SmartAXIS runs.

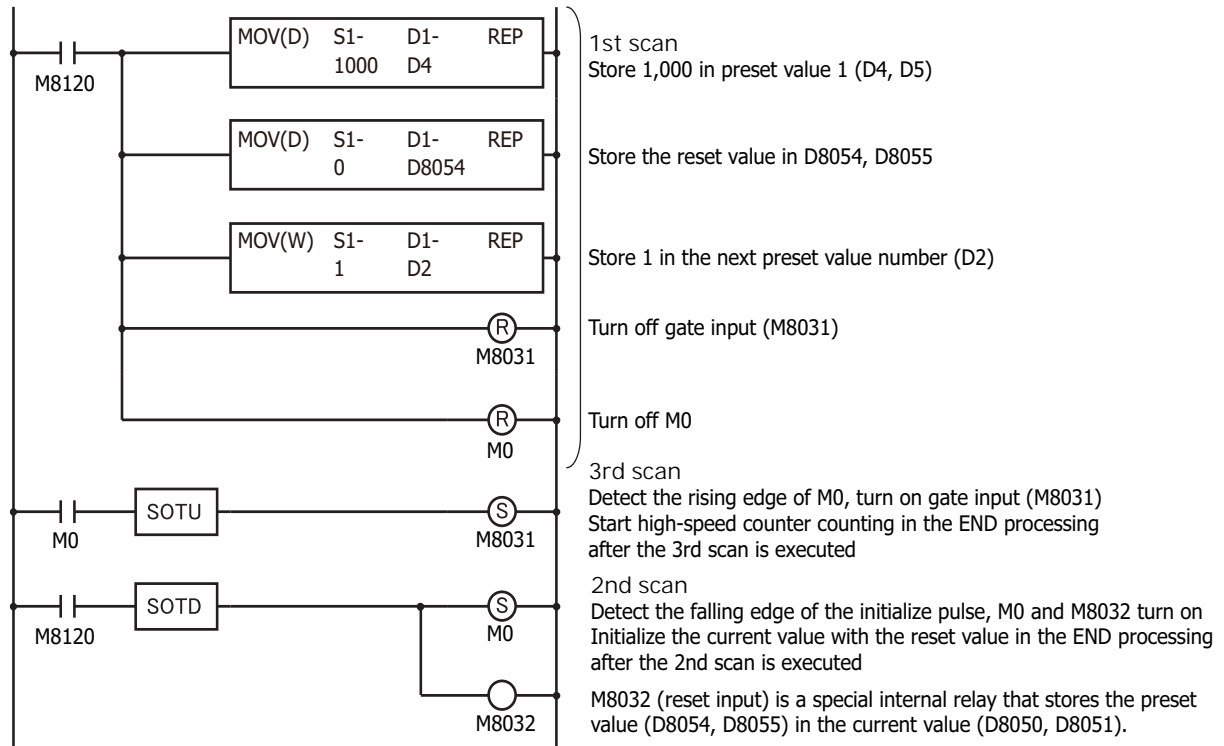

Example program 2

Using the two-phase high-speed counter, the pulses from a rotary encoder are input to the SmartAXIS and a continuous workpiece is marked at a regular interval.

Application description

- The rotary encoder pulses are input to external inputs IO and I1. A continuous sheet of paper is marked (holes are punched) at a regular interval (every 2,700 pulses).
- The rotary encoder is directly connected to the paper feed roller, and output pulses are counted by the high-speed counter and controlled.
- The cycle time is the time to count 2,700 pulses. When the hole punch time is 0.5 seconds, the operation condition is 2,700 pulse count time > 0.5 seconds.

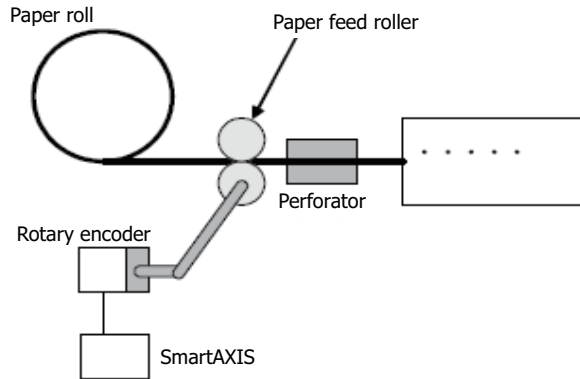

In WindLDR **Function Area Settings**, select **Two/Single-phase High-speed Counter** for **Group 1**.

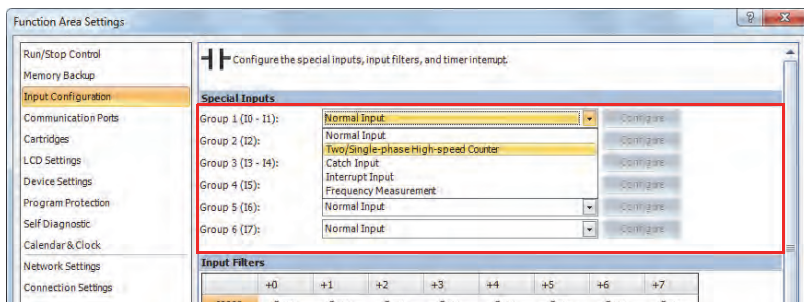

In **High-speed Counter Settings**, configure the settings as follows.

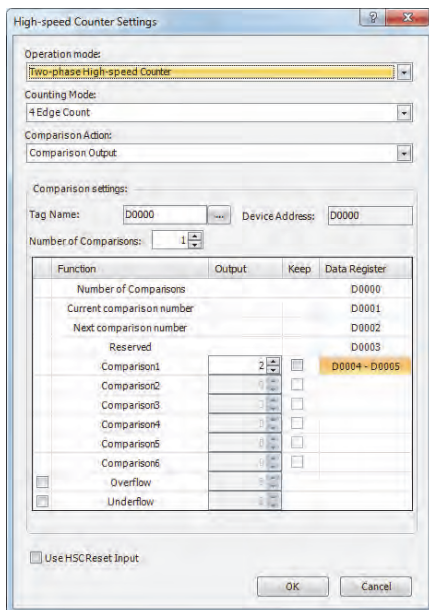

- External input : Group 1 (IO to I1)
- Operation mode : Two-phase High-speed Counter
- Counting Mode : 4-edge Count
- Comparison Action : Comparison Output

Comparison settings

- Tag name/device address : D0 (data register)
- Number of preset values : 1
- Comparison output : Q2 (external output when matched)
- Preset value 1 (D4) : 0 (upper word)
- Preset value 1 (D5) : 2,700 (lower word)
- Keep : Cleared
- Reset value (D8054) : 0 (upper word)
- Reset value (D8055) : 0 (lower word)
- Overflow : Cleared
- Underflow : Cleared
- Use HSC Reset Input : Cleared

Program

M8120 (initialize pulse) is a special internal relay that turns on when the SmartAXIS runs.

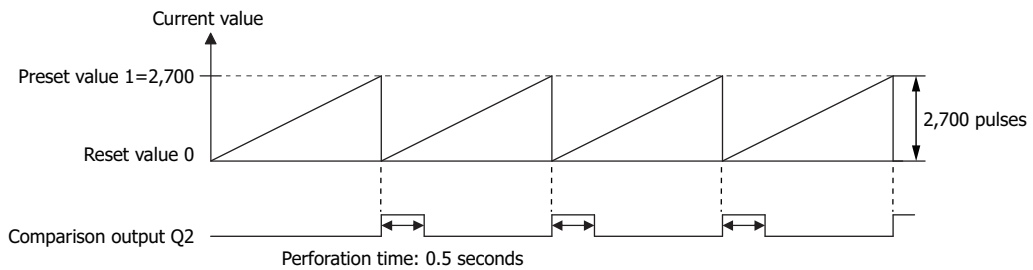
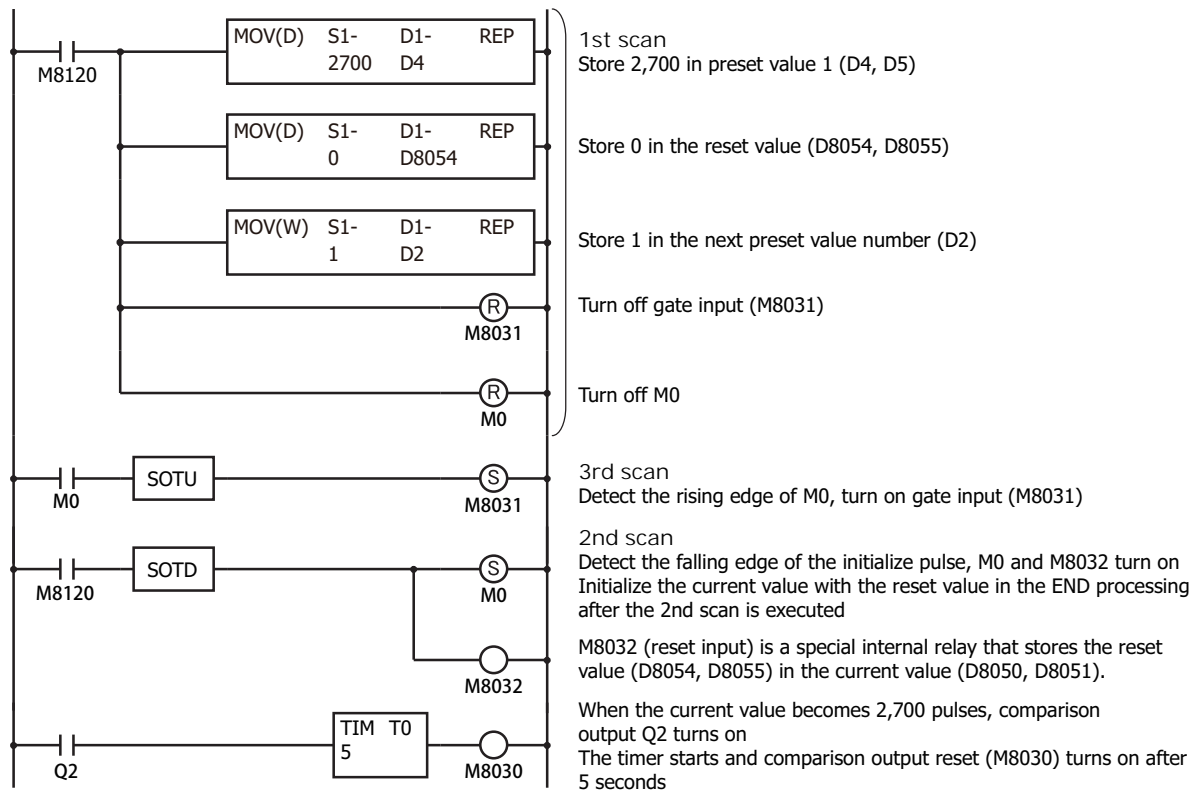

Note: In this example, Z-phase reset input is not used.

Catch Input

The catch input function is used to receive short pulses from sensor outputs regardless of the scan time. Input pulses shorter than one scan time can be received. Six inputs I0, I2, I3, and I5 through I7 can be designated to catch a rising or falling edge of short input pulses, and the catch input statuses are stored to special internal relays M8090 through M8095, respectively.

The Function Area Settings dialog box is used to designate inputs I0, I2, I3, and I5 through I7 as a catch input.

Normal input signals to input terminals are read when the END instruction is executed at the end of a scan.

Since these settings relate to the user program, the user program must be downloaded to the SmartAXIS after changing any of these settings.

Catch Input Specifications

Minimum Turn ON Pulse Width	5 μ s
Minimum Turn OFF Pulse Width	5 μ s

Note: Input filter settings have no effect on the catch inputs. For the input filter function, see "Input Filter" on page 5-38.

Catch Input Terminals and Special Internal Relays for Catch Inputs

Group	Catch Input No.	Special Internal Relay for Catch Input
Group 1	I0	M8090
Group 2	I2	M8091
Group 3	I3	M8092
Group 4	I5	M8093
Group 5	I6	M8094
Group 6	I7	M8095

Note: Only the 24-, 40-, and 48-I/O types can use external inputs I6 and I7 as catch inputs. The 12-I/O type cannot use external inputs I6 and I7 as catch inputs.

Programming WindLDR

- From the WindLDR menu bar, select **Configuration > Input Configuration**.

The Function Area Settings dialog box for Input Configuration appears.

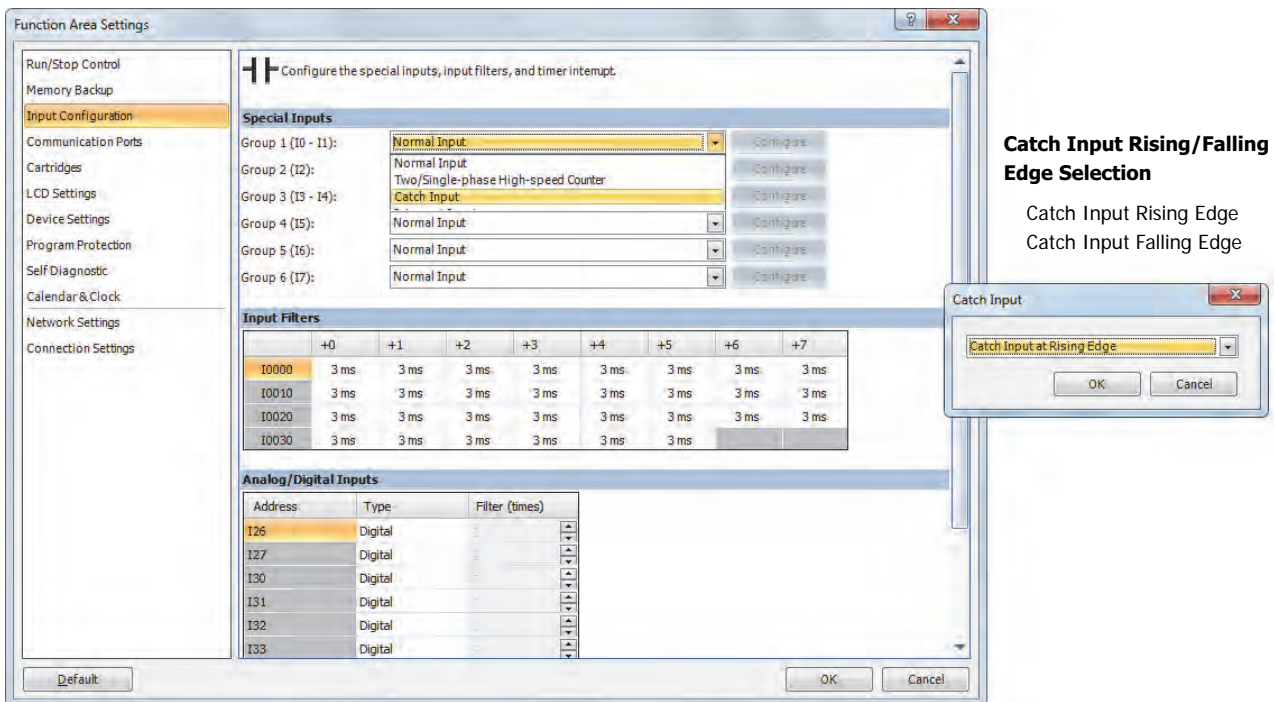

2. Select **Catch Input** in the Groups 1 through 4 pull-down list boxes. The Catch Input dialog box appears.
3. Select **Catch Input Rising Edge** or **Catch Input Falling Edge** in the pull-down list.

Catching Rising Edge of Input Pulse

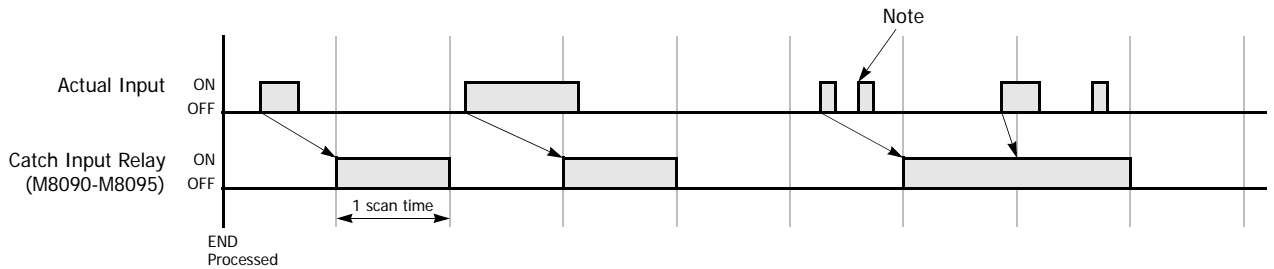

Catching Falling Edge of Input Pulse

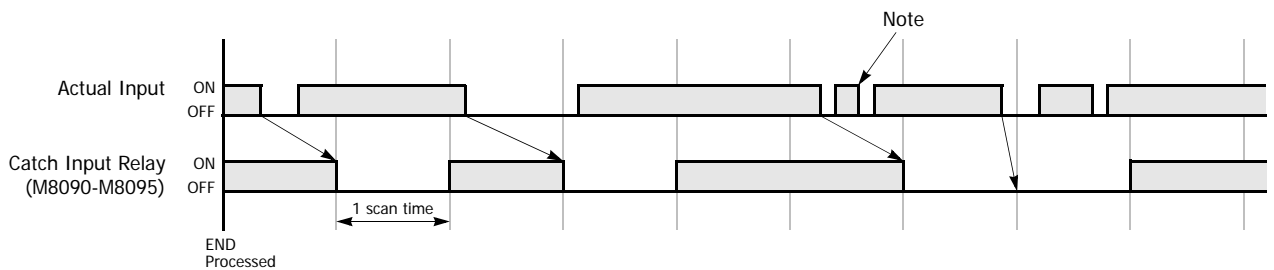

Note: When two or more pulses enter within one scan, subsequent pulses are ignored.

Example: Maintaining Catch Input

When a catch input is received, the catch input relay assigned to a catch input is turned on for only one scan. This example demonstrates a program to maintain a catch input status for more than one scan.

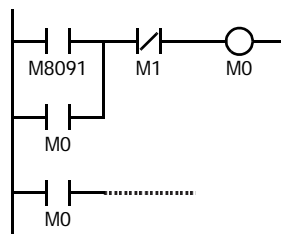

Input I2 is designated as a catch input using the Function Area Settings.

When input I2 is turned on, special internal relay M8091 is turned on, and M0 is maintained in the self-holding circuit.

When NC input M1 is turned off, the self-holding circuit is unlatched, and M0 is turned off.

M0 is used as an input condition for the subsequent program instructions.

Interrupt Input

When a quick response to an external input is required, such as positioning control, the interrupt input can call a subroutine to execute an interrupt program. The interrupt input can only be used when ladder program is selected as the programming language.

Six inputs I0, I2, I3, and I5 through I7 can be designated to execute interrupt at a rising and/or falling edge of input pulses. When an interrupt is initiated by inputs I0, I2, I3, and I5 through I7, program execution immediately jumps to a predetermined label number stored in special data registers D8032 through D8035, D8037, and D8038 respectively. The Function Area Settings dialog box is used to designate inputs I0, I2, I3, and I5 through I7 as an interrupt input, normal input, high-speed counter input, or catch input.

Normal input signals to input terminals are read when the END instruction is executed at the end of a scan.

Since these settings relate to the user program, the user program must be downloaded to the SmartAXIS after changing any of these settings.

Interrupt Input Terminals, Special Data Registers, and Special Internal Relays for Interrupt Inputs

Group	Interrupt Input No.	Interrupt Input Jump Destination Label No.	Interrupt Input Status
Group 1	I0	D8032	M8070
Group 2	I2	D8033	M8071
Group 3	I3	D8034	M8072
Group 4	I5	D8035	M8073
Group 5	I6	D8037	M8074
Group 6	I7	D8038	M8075

Note: Only the 24-, 40-, and 48-I/O types can use external inputs I6 and I7 as interrupt inputs. The 12-I/O type cannot use external inputs I6 and I7 as interrupt inputs.

Programming WindLDR

- From the WindLDR menu bar, select **Configuration > Input Configuration**. The Function Area Settings dialog box for Input Configuration appears.

Function Area Settings

Configure the special inputs, input filters, and timer interrupt.

Special Inputs

Group 1 (I0 - I1):	Normal Input	Configure
Group 2 (I2):	Normal Input	Configure
Group 3 (I3 - I4):	Two/Single-phase High-speed Counter	Configure
Group 4 (I5):	Interrupt Input	Configure
Group 5 (I6):	Normal Input	Configure
Group 6 (I7):	Normal Input	Configure

Input Filters

	+0	+1	+2	+3	+4	+5	+6	+7
I0000	3 ms	3 ms	3 ms	3 ms	3 ms	3 ms	3 ms	3 ms
I0010	3 ms	3 ms	3 ms	3 ms	3 ms	3 ms	3 ms	3 ms
I0020	3 ms	3 ms	3 ms	3 ms	3 ms	3 ms	3 ms	3 ms
I0030	3 ms	3 ms	3 ms	3 ms	3 ms	3 ms	3 ms	3 ms

Analog/Digital Inputs

Address	Type	Filter (times)
I26	Digital	
I27	Digital	
I30	Digital	
I31	Digital	
I32	Digital	
I33	Digital	

Interrupt Input

Interrupt at Rising Edge

OK Cancel

Interrupt Input Rising/ Falling Edge Selection

Interrupt at Rising Edge
Interrupt occurs when the interrupt input turns on.

Interrupt at Falling Edge
Interrupt occurs when the interrupt input turns off.

Interrupt at Both Edges
Interrupt occurs when the interrupt input turns on or off.

- Select **Interrupt Input** in the Groups 1 through 6 pull-down list boxes. the Interrupt Input dialog box appears.
- Select an interrupt edge in the pull-down list for each group.

Disable and Enable Interrupts

The interrupt inputs I0, I2, I3, and I5 through I7 and timer interrupt are normally enabled while the SmartAXIS is running, and can also be individually disabled using the DI instruction or enabled using the EI instruction. When interrupt inputs I0, I2, I3, and I5 through I7 are enabled, special internal relay M8070 through M8075 are turned on, respectively. See Chapter 16 "Interrupt Control Instructions" in the "SmartAXIS Ladder Programming Manual".

Example: Interrupt Input

The following example demonstrates a program using the interrupt input function, with input I2 designated as an interrupt input. When the interrupt input is turned on, the input I0 status is immediately transferred to output Q0 using the IOREF (I/O refresh) instruction before the END instruction is executed. For the IOREF instruction, See Chapter 15 "Refresh Instructions" in the "SmartAXIS Ladder Programming Manual".

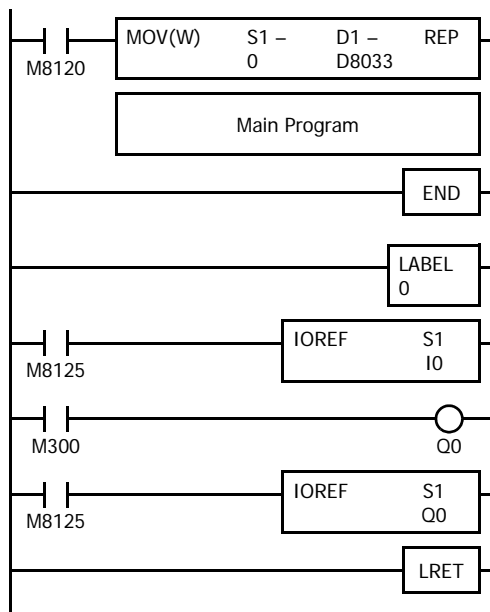

M8120 is the initialize pulse special internal relay.

D8033 stores 0 to designate jump destination label 0 for interrupt input I2.

The interrupt program is separated from the main program by the END instruction.

When input I2 is on, program execution jumps to label 0.

M8125 is the in-operation output special internal relay.

IOREF immediately reads input I0 status to internal relay M300.

M300 turns on or off the output Q0 internal memory.

Another IOREF immediately writes the output Q0 internal memory status to actual output Q0.

Program execution returns to the main program.

Insert LRET at the end of the subroutine to return to the main program.

Notes for Using Interrupt Inputs and Timer Interrupt:

- When using an interrupt input or timer interrupt, separate the interrupt program from the main program using the END instruction at the end of the main program.
- When an interrupt program calls another subroutine, a maximum of 3 subroutine calls can be nested. If more than 3 calls are nested, a user program execution error occurs, turning on special internal relay M8004 and the ERR LED.
- When using an interrupt input or timer interrupt, include the label number of the interrupt program to be executed when an interrupt occurs. The label numbers stored in data registers D8032 through D8035, D8037, and D8038 specify the interrupt programs for interrupt inputs I0, I2, I3, and I5 through I7 and timer interrupt, respectively.
- When more than one interrupt input is turned on at the same time, interrupt program execution is given priority to inputs I0, I2, I3, I5, I6, and I7, in that order. If an interrupt is initiated while another interrupt program is executed, the subsequent interrupt program is executed after the prior interrupt is completed. Multiple interrupt programs cannot be executed simultaneously.
- Make sure that the execution time of the interrupt program is shorter than interrupt intervals sufficiently.
- Interrupt programs cannot use the following instructions: SOTU, SOTD, TML, TIM, TMH, TMS, TMLO, TIMO, TMHO, TMSO, CNT, CDP, CUD, CNTD, CDPD, CUDD, SFR, SFRN, WEEK, YEAR, MSG, DI, EI, XYFS, CVXTY, CVYTX, AVRG, PULS, PWM, RAMP, ZRN, ARAMP, DTML, DTIM, DTMH, DTMS, TTIM, FIFO, NDSRC, HOUR, TXD, RXD, ETXD, ERXD, DLOG, and TRACE.

Frequency Measurement

This section describes frequency measurement, which measures the frequency of pulses input to an external input. Frequency measurement is a function that measures the frequency of pulses input to an external input.

These input pulses are processed with dedicated hardware device in SmartAXIS, so frequencies can be measured with no relation to the scan time. Groups that do not use frequency measurement can be used as normal inputs, high-speed counters, catch input, and interrupt input. The measurement results are stored in special data registers and they are updated with each scan.

Function Specification

The SmartAXIS external inputs are used by switching between normal input, high-speed counters, catch input, interrupt input, and frequency measurement. To use frequency measurement, specify the relevant group as **Frequency Measurement** in the WindLDR **Function Area Settings**.

The frequency measurement results are stored in the following special data registers (Read-only):

Group		1	2	3	4	5	6
External input		I0	I2	I3	I5	I6	I7
Frequency measurement value (32 bits)	Upper word	D8050	D8056	D8062	D8068	D8134	D8140
	Lower word	D8051	D8057	D8063	D8069	D8135	D8141
Frequency measurement range		1 Hz to 100 kHz		200 Hz to 100 kHz			
Measurement error		Less than $\pm 1\%$ (Truncated after the decimal point)					
Calculation cycle		Each scan time					

Notes:

- If the input pulse cycle is longer than the scan time, the measurement results are updated at pulse cycle + 1 scan time.
- The data registers for the upper word and the lower word of the measurement value change according to the 32-bit data storage method specified. For details, see "32-bit Data Storage Setting" on page 5-62.

Applicable Models

- The AC power type does not support frequency measurement. In situations where the frequency measurement function is required, use the DC power type.
- Of the DC power types, only the the 24-, 40-, and 48-I/O types can use external inputs I6 and I7 for frequency measurement. The 12-I/O type cannot use external inputs I6 and I7 as the frequency measurement function.

Programming WindLDR

To use frequency measurement, you must configure the **Function Area Settings** in WindLDR and download the user program to the SmartAXIS. Frequency measurements will start when you download the user program and set the SmartAXIS to run.

1. From the WindLDR menu bar, select **Configuration > Input Configuration**.
The Function Area Settings dialog box is displayed.
2. Specify **Frequency Measurement** for the group to use frequency measurement.

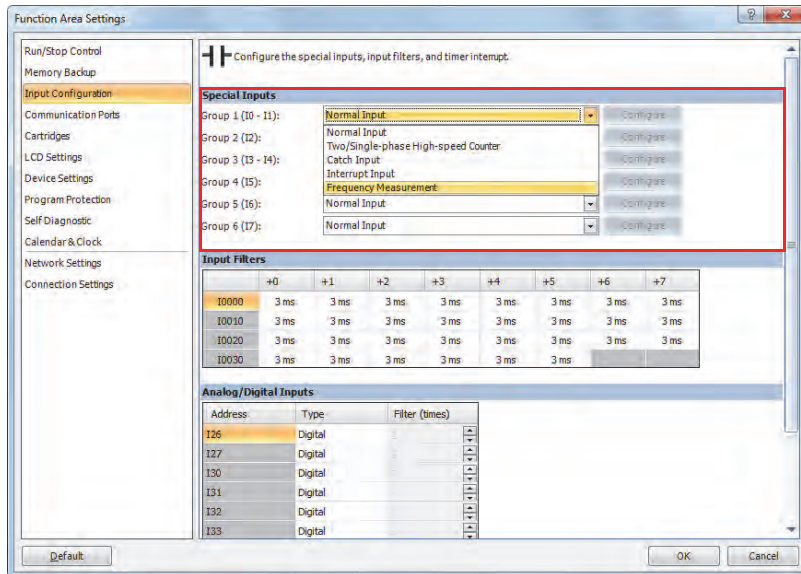

3. Click **OK**.
This concludes configuring the settings.

Input Filter

The input filter function is used to reject input noises. The catch input function described in the preceding section is used to read short input pulses to special internal relays. To the contrary, the input filter rejects short input pulses when the SmartAXIS is used with input signals containing noises.

Different input filter values can be selected for inputs I0 through I17 in four groups using the Function Area Settings. Selectable input filter values to pass input signals are 0ms, and 3 through 15ms in 1ms increments. Default value is 3ms for all inputs I0 through I17. Inputs I10 and above on SmartAXIS are provided with a fixed filter of 3ms. The input filter rejects inputs shorter than the selected input filter value minus 2ms.

Normal inputs require a pulse width of the filter value plus one scan time to receive input signals. When using the input filter function, select **Normal Input** under Special Inputs on the Input Configuration dialog box in the Function Area Settings.

Since these settings relate to the user program, the user program must be downloaded to the SmartAXIS after changing any of these settings.

Programming WindLDR

1. From the WindLDR menu bar, select **Configuration > Input Configuration**.

The Function Area Settings dialog box for Input Configuration appears.

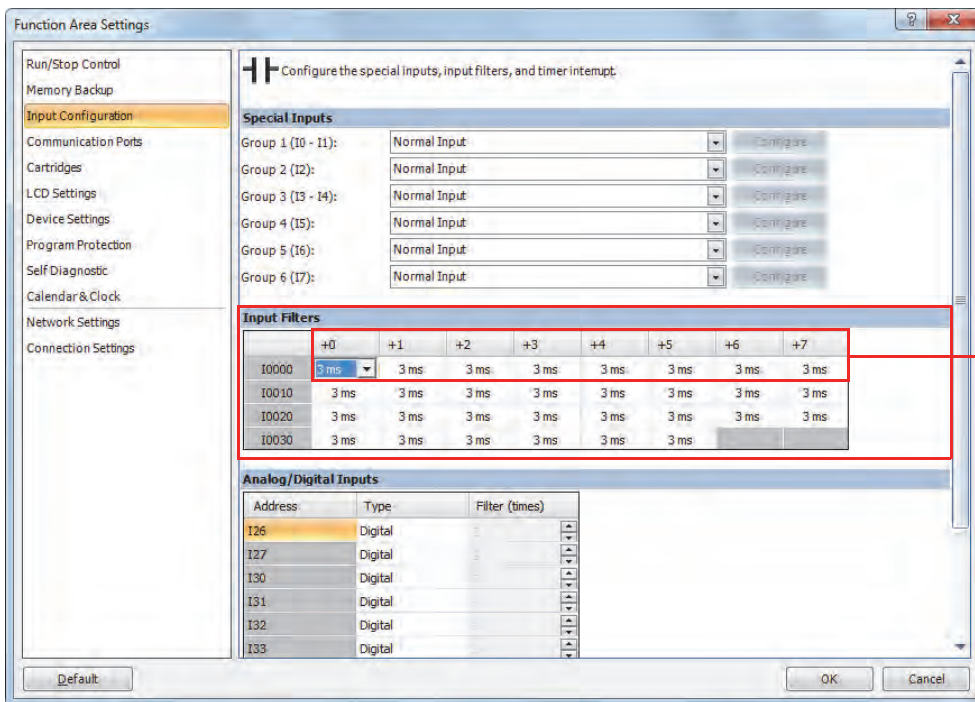

The columns displayed next to I0 indicate I0 to I17.

2. Select an input filter value for each group of inputs.

Input Filter Values and Input Operation

Depending on the selected values, the input filter has three response areas to reject or pass input signals.

- Reject area:** Input signals do not pass the filter (selected filter value minus 2 ms).
- Indefinite area:** Input signals may be rejected or passed.
- Pass area:** Input signals pass the filter (selected filter value).

Example: Input Filter 8ms

To reject input pulses of 6ms or less, select input filter value of 8ms. Then input pulses of 8ms plus one scan time are accepted correctly at the END processing.

	6ms	8ms + 1 scan
Input	Rejected	Accepted

Analog Input

This section describes input analog signals such as those from pressure sensors.

The SmartAXIS is equipped with embedded analog inputs. This function acquires 0 to 10V DC voltage analog input by converting it into 0 to 1000 digital values. The converted analog signals are stored in special data registers. External inputs that are not specified as analog inputs are digital inputs.

For the on/off threshold value when digital input is specified, see "Product Specifications" on page 2-1.

Note: When analog input is configured as digital input, the input filter is active.

Analog input value storage locations

A maximum of eight analog inputs can be used. The converted analog signals are stored in special data registers (D8040 to D8047: read-only) as values between 0 and 1000. These values are updated with each scan.

Analog input (I)	0	1	2	3	4	5	6	7
Special data register that stores the analog input value	D8040	D8041	D8042	D8043	D8044	D8045	D8046	D8047

Analog Input Filter

The analog input data is averaged by the specified filter count. This can reduce rapid fluctuations in analog input.

The larger this value is set, the slower the tracking of the change in analog input becomes.

Count	Description
0	No filtering
1 to 255	The input value is set as the average value of n samples of analog input data. (n: Count)

When filtering, the input value is calculated with the equation below.

$$\text{Analog input value after filtering} = \frac{\text{Total analog input values for filter count (n) worth of scans}}{\text{Filter count n}}$$

Analog Input Allocation

The analog inputs are shared with the digital inputs. The allocation of analog inputs varies based on to the model.

12-I/O type

Input (I)	0	...	5	6	7
Analog input (AI)	—	—	—	0	1
Special data register that stores the analog input value	—	—	—	D8040	D8041

24-I/O type

Input (I)	0	...	13	14	15	16	17
Analog input (AI)	—	—	—	0	1	2	3
Special data register that stores the analog input value	—	—	—	D8040	D8041	D8042	D8043

40-I/O type

Input (I)	0	...	21	22	23	24	25	26	27
Analog input (AI)	—	—	—	0	1	2	3	4	5
Special data register that stores the analog input value	—	—	—	D8040	D8041	D8042	D8043	D8044	D8045

48-I/O type

Input (I)	0	...	25	26	27	30	31	32	33	34	35
Analog input (AI)	—	—	—	0	1	2	3	4	5	6	7
Special data register that stores the analog input value	—	—	—	D8040	D8041	D8042	D8043	D8044	D8045	D8046	D8047

5: SPECIAL FUNCTIONS

Applicable Models

The number of inputs that can be used for analog input varies based on the model.

The AC power type does not support analog input. In situations where the analog input function is required, use the DC power type.

Power supply voltage	100 to 240V AC				24V DC			
Type	12-I/O type	24-I/O type	40-I/O type	48-I/O type	12-I/O type	24-I/O type	40-I/O type	48-I/O type
Analog inputs	0				2	4	6	8

Programming WindLDR

To use analog input, you must configure the Function Area Settings in WindLDR and download the user program to the SmartAXIS.

- From the WindLDR menu bar, select **Configuration > Input Configuration**.
The Function Area Settings dialog box is displayed.
- Specify **Analog** for the external input to use as analog input and configure **Filter Count**.
Click **Default** to set all the external inputs to digital.

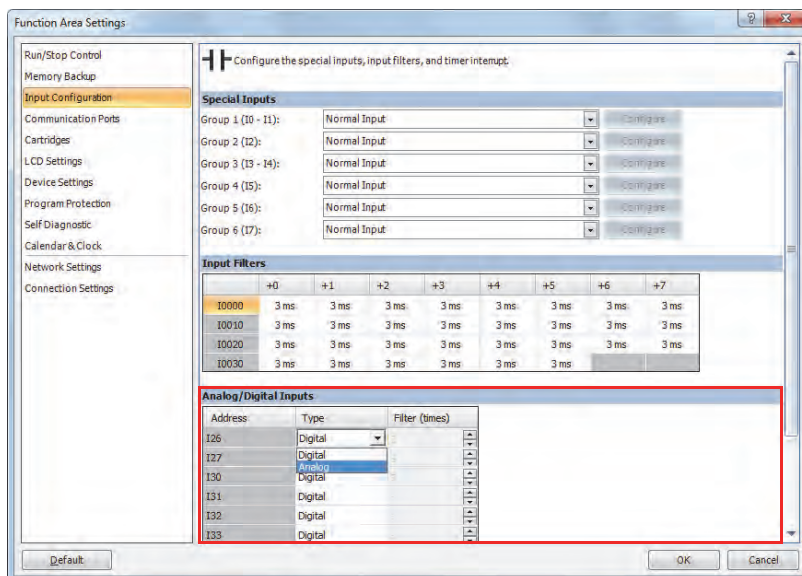

- Click **OK**.
This concludes configuring the settings.

Timer Interrupt

In addition to the interrupt input as described in the preceding section, all SmartAXIS have a timer interrupt function. When a repetitive operation is required, the timer interrupt can be used to call a subroutine repeatedly at predetermined intervals of 10 through 140ms. The timer interrupt can only be used when ladder program is selected as the programming language.

The Function Area Settings dialog box is used to enable the timer interrupt and to specify the interval, from 10 to 140ms, to execute the timer interrupt. When the timer interrupt is enabled, the program execution repeatedly jumps to the jump destination label number stored in special data register D8036, while the SmartAXIS is running. When the interrupt program is completed, the program execution returns to the main program at the address where the interrupt occurred.

Since these settings relate to the user program, the user program must be downloaded to the SmartAXIS after changing any of these settings.

Special Data Register and Special Internal Relay for Timer Interrupt

Interrupt	Special Data Register for Timer Interrupt Jump Destination Label No.	Special Internal Relay for Timer Interrupt Status
Timer Interrupt	D8036	M8144

Note: A label is the starting address of the program branch to jump to, and it is specified by the LABEL instruction.

Programming WindLDR

- From the WindLDR menu bar, select **Configuration > Input Configuration**.
The Function Area Settings dialog box for Input Configuration appears.

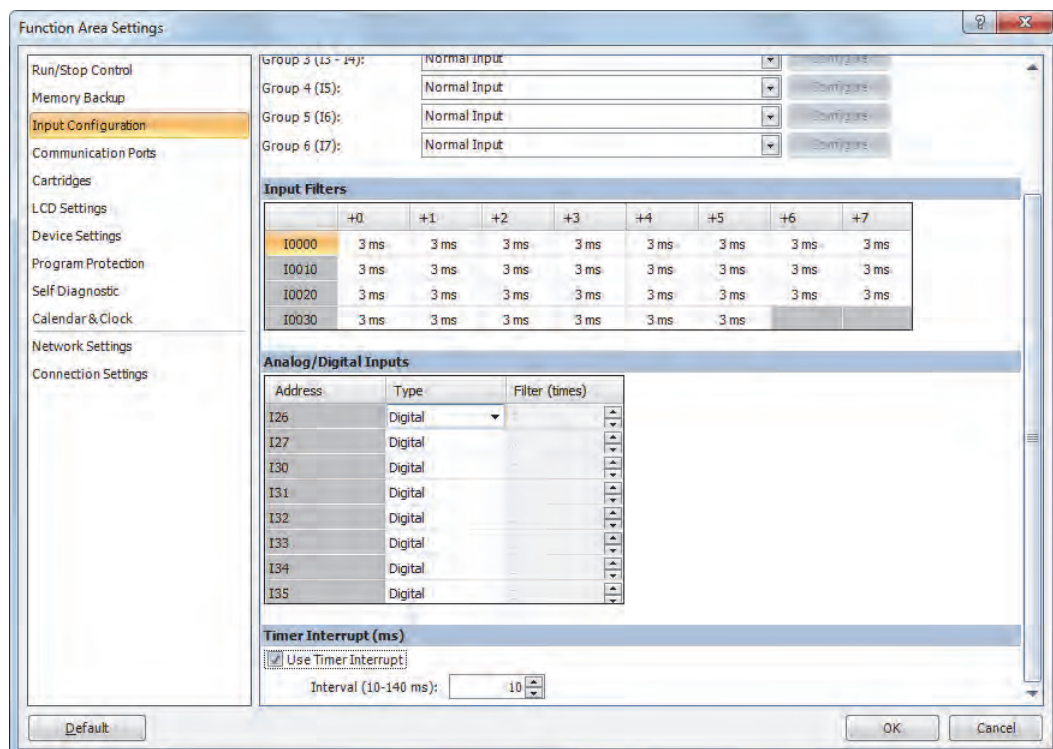

- Under the Timer Interrupt, click the check box to use the timer interrupt function.
- Select an interval to execute the timer interrupt, from 10 to 140ms.

Disable and Enable Interrupts

The timer interrupt and interrupt inputs I0, I2, I3, and I5 through I7 are normally enabled while the SmartAXIS is running, and can also be individually disabled using the DI instruction or enabled using the EI instruction. When timer interrupt is enabled, M8144 is turned on. When disabled, M8144 is turned off. See Chapter 16 "Interrupt Control Instructions" in the "SmartAXIS Ladder Programming Manual".

Example: Timer Interrupt

The following example demonstrates a program of using the timer interrupt function. The Function Area Settings must also be completed to use the timer interrupt function as described on the preceding page.

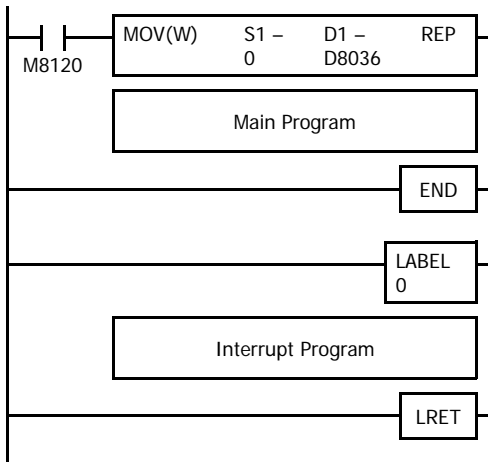

M8120 is the initialize pulse special internal relay.

D8036 stores 0 to designate jump destination label 0 for timer interrupt.

The interrupt program is separated from the main program by the END instruction.

While the SmartAXIS is running, program execution jumps to label 0 repeatedly at intervals selected in the Function Area Settings.

Each time the interrupt program is completed, program execution returns to the main program at the address where timer interrupt occurred.

Insert LRET at the end of the subroutine to return to the main program.

Notes for Using Timer Interrupt and Interrupt Inputs:

- When using a timer interrupt or interrupt input, separate the interrupt program from the main program using the END instruction at the end of the main program.
- When an interrupt program calls another subroutine, a maximum of 3 subroutine calls can be nested. If more than 3 calls are nested, a user program execution error occurs, turning on special internal relay M8004 and the ERR LED.
- When using a timer interrupt or interrupt input, include the label number of the interrupt program to be executed when an interrupt occurs. The label numbers stored in data registers D8032 through D8035, D8037, and D8038 specify the interrupt programs for interrupt inputs I0, I2, I3, and I5 through I7 and timer interrupt, respectively.
- If an interrupt is initiated while another interrupt program is executed, the subsequent interrupt program is executed after the prior interrupt is completed. Multiple interrupt programs cannot be executed simultaneously.
- Make sure that the execution time of the interrupt program is shorter than interrupt intervals sufficiently.
- Interrupt programs cannot use the following instructions: SOTU, SOTD, TML, TIM, TMH, TMS, TMLO, TIMO, TMHO, TMSO, CNT, CDP, CUD, CNTD, CDPD, CUDD, SFR, SFRN, WEEK, YEAR, MSG, DI, EI, XYFS, CVXTY, CVYTX, AVRG, PULS, PWM, RAMP, ZRN, ARAMP, DTML, DTIM, DTMH, DTMS, TTIM, FIFOF, NDSRC, HOUR, TXD, RXD, ETXD, ERXD, DLOG, TRACE, and SCRPT.

Forced I/O function

Inputs can be forced on/off regardless of the status of physical inputs, and outputs can be forced on/off regardless of the ladder logic using the forced I/O function in WindLDR. The force input function can be used to monitor or online edit mode to test the ladder logic without the need of wiring the input terminals or turning on the actual inputs. The force output function can be used to turn on/off the outputs to the external devices.



Caution

- The forced I/O may cause unexpected operation of the SmartAXIS. Make sure of safety before forcing inputs or outputs.

Devices

All the inputs and outputs of the SmartAXIS can be forced on/off individually.

Type	Device Range	
	Inputs	Outputs
12-I/O type	I0 to I7	Q0 to Q3
24-I/O type	I0 to I17, I40 to I75, I80 to I115, I120 to I155	Q0 to Q7, Q40 to Q61, Q80 to Q101, Q120 to Q141
40-I/O type	I0 to I27, I40 to I75, I80 to I115, I120 to I155	Q0 to Q17, Q40 to Q61, Q80 to Q101, Q120 to Q141
48-I/O type	I0 to I35, I40 to I75, I80 to I115, I120 to I155	Q0 to Q21, Q40 to Q61, Q80 to Q101, Q120 to Q141

Forced I/O Status

Events of the SmartAXIS and effects on the forced I/O settings are shown below.

Events	Forced I/O Status
When the SmartAXIS starts running	The force settings are retained. The forced inputs and outputs are kept on/off even after the SmartAXIS is stopped, regardless of the status of M8025 (maintain outputs while SmartAXIS is stopped).
When the SmartAXIS is stopped.	
When the SmartAXIS is powered up	The force settings are retained, but the force is suspended. If the battery is dead, the force settings are cleared.
When user program download is executed	The force settings are retained, and whether the force will be suspended or not can be selected in the Download Program dialog box.
When Reset Input is turned on	The force settings are cleared.
When Clear All Devices is executed in the PLC Status dialog box of WindLDR	
When the system software download is executed	

Note: Force function has no effect on high-speed counters, catch inputs, or interrupt inputs. The stop or reset input can be initiated using the force function, but the force settings will be cleared as soon as the reset input is turned on.

Checking the Forced I/O Function Execution State

The state of the forced I/O function (running or stopped) can be checked with WindLDR, with the SmartAXIS module error status LED (SmartAXIS Lite only), or with the RUN or STOP screen on the module's LCD (SmartAXIS Pro only). The forced I/O function execution state while stopped cannot be checked with the module's power/run status LED. For the power/run status LED, see "Product Specifications" on page 2-1.

Programming WindLDR

1. From the WindLDR menu bar, select **Online > Monitor > Monitor**.
Online mode is activated.

2. From the WindLDR menu bar, select **Online > Forced I/O**.

The Forced I/O List dialog box appears and shows a list of forced inputs and outputs. I/O numbers and force I/O statuses can be specified in this dialog box.

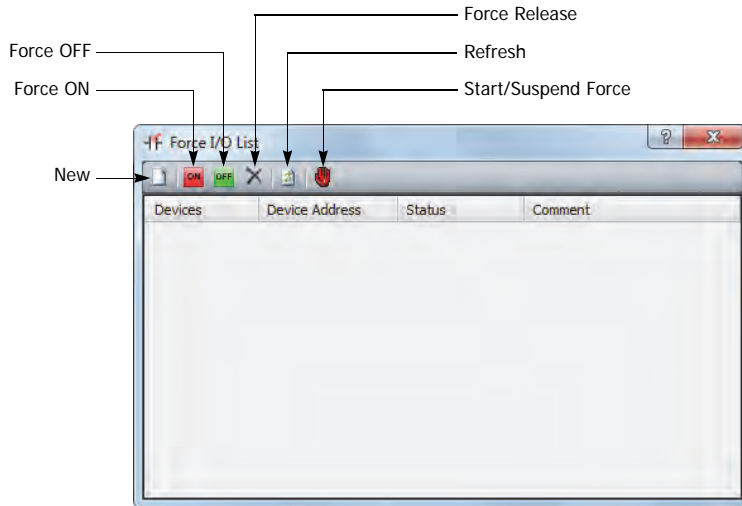

3. Click the New button and type an input or output number under Device in the list.
Click the Force On button or Force Off button to force on or off the designated input or output.

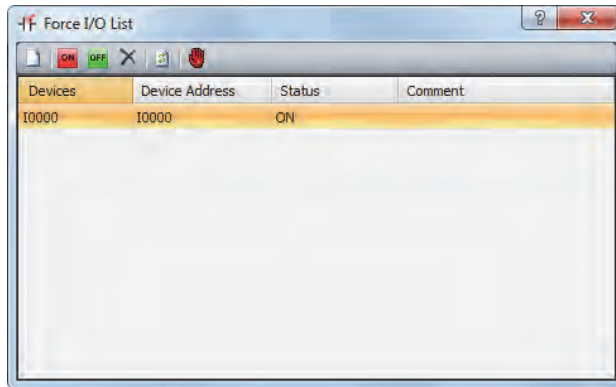

4. To start the forced I/O function, click the Start/Suspend Force button .

A sign is displayed to show input IO is forced.

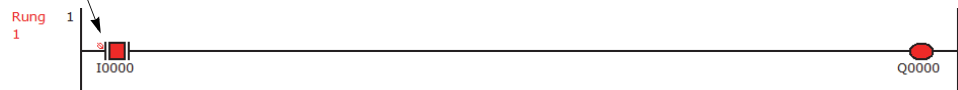

The forced I/O can be suspended temporarily by clicking the Start/Suspend Force button again.

5. To suspend the forced I/O, click the Start/Suspend Force button .

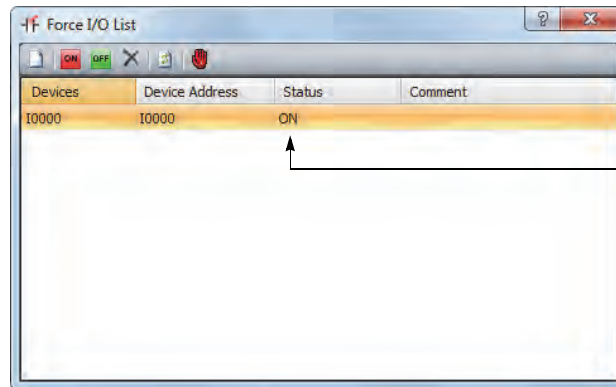

Even though I0 is designated, forced I/O is suspended and actual input status is read to the SmartAXIS.

The forced inputs or outputs remain designated until the forced I/O designation is released.

6. To release the forced I/O designation, click the Force Release button .

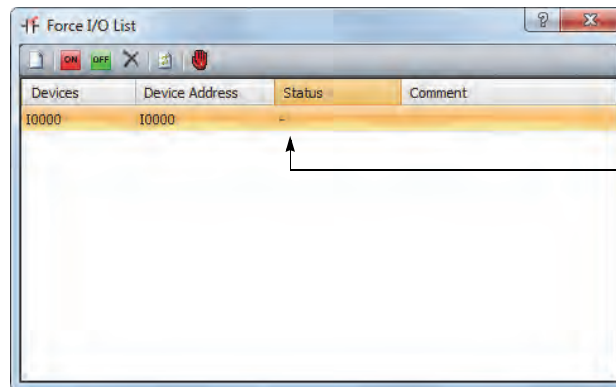

Input I0 is released from the forced I/O designation. Even when forced I/O is enabled, actual input status is read to the SmartAXIS.

Now input I0 works as a normal input.

Note: Make sure that all the forced inputs and outputs are released when the test using the forced I/O function is finished. Select **Delete All** from the right click menu in the Forced I/O List dialog box to release all the forced inputs and outputs at once.

Communication Ports

This section describes how to connect the SmartAXIS to other devices and how to communicate with them.

The SmartAXIS is equipped with a USB port, expansion communication ports (RS232C and RS485), and an Ethernet port. The SmartAXIS can communicate with connected devices via maintenance communication, user communication, Modbus communication, and remote I/O by configuring the port and communication method for connected devices.

• Communication ports

All models are equipped with a USB port. The 24-, 40-, and 48-I/O types are equipped with optional RS232C or RS485 expansion communication ports. The 24-, 40-, and 48-I/O types are equipped with an Ethernet port.

USB port	Maintenance communication can be performed by connecting the SmartAXIS and a computer with a USB cable.
Ethernet port	The SmartAXIS can communicate with Ethernet-compatible devices such as computers and operator interfaces. Maintenance communication, user communication, Modbus communication, and remote I/O are all possible.
Expansion communication ports	Maintenance communication, user communication, and Modbus RTU communication are all possible.

• Communication functions

For details on the communications functions, see the chapter for each function.

Maintenance communication (Chapter 9)	Maintenance communication enables you to check the operating status and I/O status of the SmartAXIS, monitor and change device values, and download and upload user programs using a computer or operator interface.
User communication (Chapter 10)	The SmartAXIS can communicate with external devices equipped with RS232C, RS485, or Ethernet ports using user communication.
Modbus communication (Chapter 11)	The SmartAXIS can send and receive data with Modbus compliant devices on RS232C, RS485, or Ethernet port.

Communication Ports and Communication Methods

The communication methods supported by each communication port are as follows.

Communication Methods		USB Port	Expansion Communication Port (port 2, 3)		Ethernet Port
			RS232C	RS485	
Maintenance communication	System firmware downloads	Yes	No	No	No
	User program downloads/uploads		No	No	Yes
	Monitoring/changing devices		Yes	Yes	Yes
User communication		No	Yes	Yes	Yes
Modbus RTU	Master	No	Yes	Yes	No
	Slave				
Modbus TCP	Client	No	No	No	Yes
	Server				
Remote I/O	Master	No	No	No	Yes
	Slave				

Expansion Communication Port Wiring Diagram

The mini-DIN connector pin assignments and signal names are as follows.

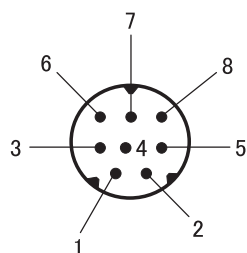

RS232C (FT1A-PC1)

Pin Number	Signal Name		Cable Color	Signal Direction	Peripheral Device (D-SUB)
	Port 2	Port 3			
Cover	Port 2	Port 3	Shield	—	RS232C
1	RS (RTS)	RS (RTS)	Black	→	(DR)
2	ER (DTR)	ER (DTR)	Yellow	→	(CTS)
3	SD (TXD)	SD (TXD)	Blue	→	RD
4	RD (RXD)	RD (RXD)	Green	←	SD
5	DR (DSR)	DR (DSR)	Brown	←	RS
6	SG	SG	Gray	None	SG
7	SG	SG	Red		SG
8	NC	NC	White		NC

RS485 (FT1A-PC2)

Pin Number	Signal Name		Cable Color	Signal Direction	Peripheral Device (D-SUB)
	Port 2	Port 3			
Cover	Port 2	Port 3	Shield	—	RS485
1	A	A	Black	↔	A
2	B	B	Yellow	↔	B
3	NC	NC	Blue		NC
4			Green		
5			Brown		
6			Gray		
7	SG	SG	Red	—	SG
8	NC	NC	White	None	NC

Note: Do not connect cables to NC. There is a risk of malfunction or failure.

Programming WindLDR

Configure the communication format according to the communication specifications of the device.

1. From the WindLDR menu bar, select **Configuration > Communication Ports**.
The Function Area Settings dialog box is displayed.
2. In the **Communication Mode** pull-down list for the appropriate port, select the communication mode.
The configuration dialog that corresponds to the communication mode is displayed.

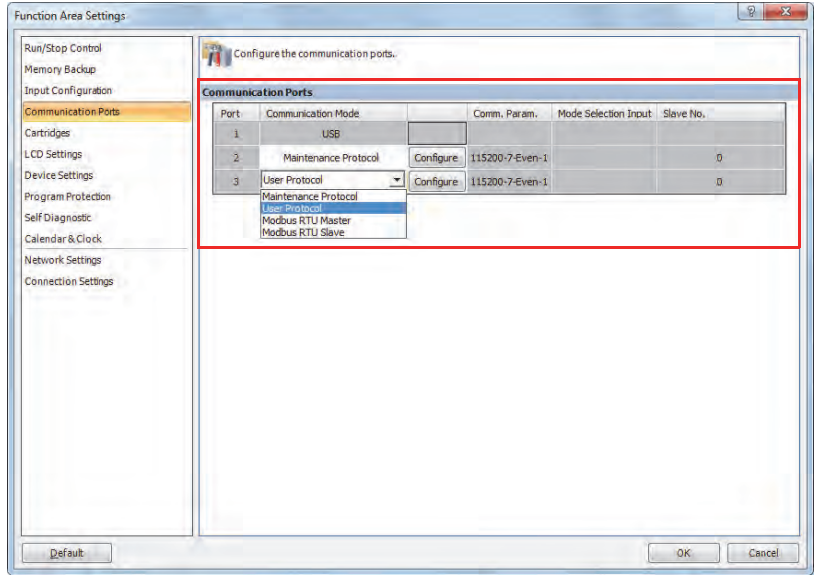

3. Change the settings on the configuration dialog according to the communication format for the destination device.
A user communication example is shown below.

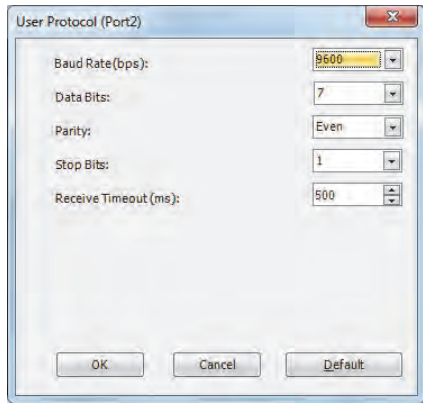

4. Click **OK**.
This concludes configuring the settings.

Memory Cartridge

This section describes the memory cartridge used to save SmartAXIS user programs.

A user program can be saved on the memory cartridge. Insert a memory cartridge into the SmartAXIS and the user program on that memory cartridge is subject to priority execution over the user program in the SmartAXIS module's ROM. If a user program is not present in the memory cartridge, the user program in the SmartAXIS module's ROM is executed.

Memory Cartridge	User Program to Execute
Equipped	The user program on the memory cartridge is executed.
Not equipped	The user program in the SmartAXIS module's ROM is executed.

Specifications

Name	Function/Purpose	Model Number
Memory cartridge	User program save memory (One user program can be saved)	FT1A-PM1

Downloading and uploading user programs

The user program on the memory cartridge can be downloaded to the SmartAXIS module when the SmartAXIS is powered with the function area settings. Or when uploading to the memory card is configured with WindLDR, the user program can be uploaded to the memory cartridge inserted in the SmartAXIS.

For the SmartAXIS Pro, the user program on the memory cartridge can be downloaded or uploaded to the SmartAXIS Pro module with the LCD and operation buttons.

Notes:

- Always turn the SmartAXIS off before removing or installing a memory cartridge. If the memory cartridge is inserted or removed with the power on, SmartAXIS operation cannot be guaranteed. There is a risk of the product failing.
- The memory cartridge may break if dropped. Take care not to drop it when removing it.

SmartAXIS system firmware compatibility

If the user program on the inserted memory cartridge includes instructions/FB not supported by the SmartAXIS module's system firmware, a program error will occur. Update the SmartAXIS module's system firmware to the latest version with WindLDR.

Download Settings

The user program on the memory cartridge can be downloaded to the SmartAXIS module. If a user program already exists on the SmartAXIS module, that user program will be overwritten.

First configure the user program to automatically download to the SmartAXIS module in the WindLDR function area settings, then download the user program to the memory cartridge. When a memory cartridge configured with download settings is inserted into the SmartAXIS and the power is turned on, the user program on the memory cartridge is automatically downloaded to the SmartAXIS. For the SmartAXIS Pro, the user program can also be downloaded using the LCD and operation buttons.

Programming WindLDR

Insert the memory cartridge into the SmartAXIS, turn the power on, and then connect the SmartAXIS to the computer (WindLDR).

1. From the WindLDR menu bar, select **Configuration > Cartridge**.
The Function Area Settings dialog box is displayed.
2. Select the **Enable Memory Cartridge Download** check box.

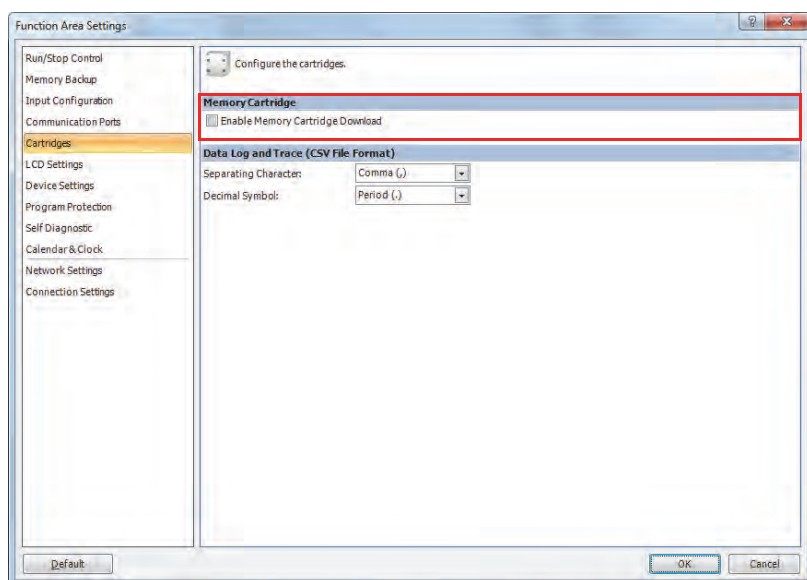

3. Click **OK**.
This concludes configuring the settings for the memory cartridge to download the user program to the SmartAXIS.
4. Download the user program from the memory cartridge that is inserted in the SmartAXIS.
5. Turn off the SmartAXIS power and remove the memory cartridge.
6. Insert the memory cartridge into the SmartAXIS you want to download the user program to, and turn the power on.
The user program on the memory cartridge is automatically downloaded to the SmartAXIS module.

Upload Settings

The SmartAXIS module user program can be uploaded to the memory cartridge. First configure the settings for the memory cartridge to automatically upload the user program from the SmartAXIS module in WindLDR. If a user program already exists on the memory cartridge, the user program on the memory cartridge is deleted and the upload settings are configured. When a memory cartridge configured with upload settings is inserted in the SmartAXIS and the power is turned on, the user program on the SmartAXIS module is automatically uploaded to the memory cartridge. The upload to the memory cartridge configured with upload settings is valid only one time. To upload the user program again, configure the settings for the memory cartridge to automatically upload the user program. For the SmartAXIS Pro, the user program on the SmartAXIS module can be uploaded to the memory cartridge with the LCD and operation buttons. If a user program already exists on the memory cartridge, the user program on the memory cartridge is deleted and the user program is uploaded.

Programming WindLDR

1. Insert the memory cartridge into the SmartAXIS, turn the power on, and then connect the SmartAXIS to the computer (WindLDR).
2. From the WindLDR menu bar, select **Online > Upload > Memory Cartridge Upload**.

The Memory Cartridge Upload dialog box is displayed.

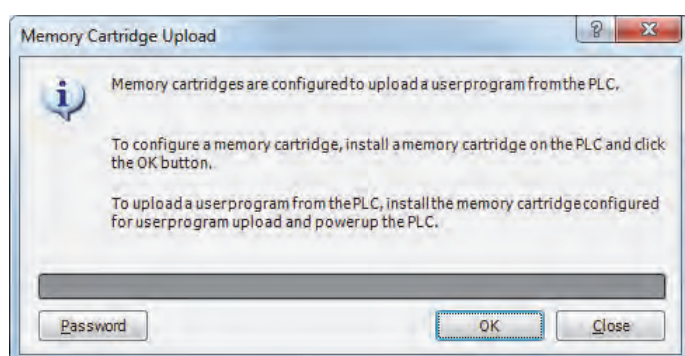

Note: If the user program on the SmartAXIS to upload is password protected, click **Password** and enter the password.

3. Click **OK**.
The user program on the memory cartridge is deleted at this time.
4. Turn off the SmartAXIS power and remove the memory cartridge.
This concludes configuring the settings for the memory cartridge to upload the user program from the SmartAXIS.
5. Insert the memory cartridge with the completed upload settings into the SmartAXIS and turn the power on.
The user program is automatically uploaded from the SmartAXIS module to the memory cartridge.

Notes:

In the following situations, a memory cartridge transfer error will occur. If the error occurs, the user program is not uploaded to the memory cartridge, and SmartAXIS operation stops.

- When the SmartAXIS user program upload protection is set to **Prohibited**
- When the SmartAXIS user program password protection is set and the memory cartridge password does not match

For user program protection, see "User Program Protection" on page 5-64.

User Program Passwords

When password protection is configured for the SmartAXIS module user program, uploads and downloads only happen when the password configured for the memory cartridge and the SmartAXIS module user program password match.

For user program protection, see "User Program Protection" on page 5-64.

Type	Password match	Password does not match
SmartAXIS Pro	Enter the password with the module's LCD and operation buttons.	Enter the password with the module's LCD and operation buttons.
SmartAXIS Lite	Automatic upload/download	Automatic upload/download not possible

SD Memory Card

This section describes how to save log data to the SD memory card and maintain the SD memory card.

The 40- and 48-I/O types SmartAXIS are equipped with an SD memory card slot, and SD memory cards with 32GB maximum capacity can be used. Device values (log data) can be output to the SD memory card as CSV files using the DLOG (data log) and the TRACE (data trace) instructions/FB. This enables log saved and analyzed when problems occur. The contents of the files saved to the SD memory card can be checked on a computer. The files saved to the SD memory card can be uploaded using WindLDR.

Function	Description	Reference
Save log data	Specified device values can be saved to the SD memory card as CSV files using the DLOG and TRACE instructions/FB.	5-52
SD memory card maintenance with WindLDR	The SD memory card data can be read to a computer or deleted by using WindLDR. SD memory card data can be managed and checked.	5-53

For the SD memory card hardware specifications, see "Product Specifications" on page 2-1.

Notes:

- Set the write-protect switch on the SD memory card to the off position before inserting it.
- Insert and remove the SD memory card in the direction indicated on the SmartAXIS module.
- Do not remove the SD memory card while it is being accessed. There is a risk of damage to the SD memory card and the data stored on it.

Save Log Data

Using the DLOG (data log) and the TRACE (data trace) instructions/FB, specified device values are saved to the SD memory card as the log data (CSV files). The DLOG instruction/FB outputs the date and time and the device values of the specified devices to the CSV file in the specified folder. The TRACE instruction/FB outputs the date and time and the device values of the previous number of scans for the specified devices to the CSV file in the specified folder. For details on the DLOG and TRACE instructions, see Chapter 26 "Data Log Instructions" in the SmartAXIS Ladder Programming Manual. For details on the DLOG and TRACE FB, see Chapter 16 "The data logging FB" in the SmartAXIS FBD Programming Manual.

The SmartAXIS cannot write data to the SD memory card when its write-protect switch is on. Always set the write-protect switch of the SD memory card to off position before inserting it to the SmartAXIS.

• CSV file output sample with the DLOG instruction/FB

Time	D0010	D0011
2011/09/07 15:40:00	12345	1
2011/09/07 15:41:00	1212	3
2011/09/07 15:42:00	345	4

• CSV file output sample with the TRACE instruction/FB

Triggered at:	2011/09/07 15:40		
Scan	D0010	D0011	D0012
Old	1	9	17
	2	10	18
New	3	11	19

SD Memory Card Maintenance with WindLDR

You can browse and manipulate files on the SD memory card inserted in the SmartAXIS using Data File Manager of WindLDR.

- Browse folders and files on the SD memory card.
- Upload files on the SD memory card.
- Delete folders and files on the SD memory card.
- Format the SD memory card.

To browse and manipulate the files on the SD memory card inserted in the SmartAXIS using the Data File Manager, connect the computer and the SmartAXIS with either of these methods.

- Connect the USB port on the computer and the USB port on the SmartAXIS with a USB maintenance cable.
- Connect the Ethernet port on the computer and the Ethernet port on the SmartAXIS with an Ethernet cable.

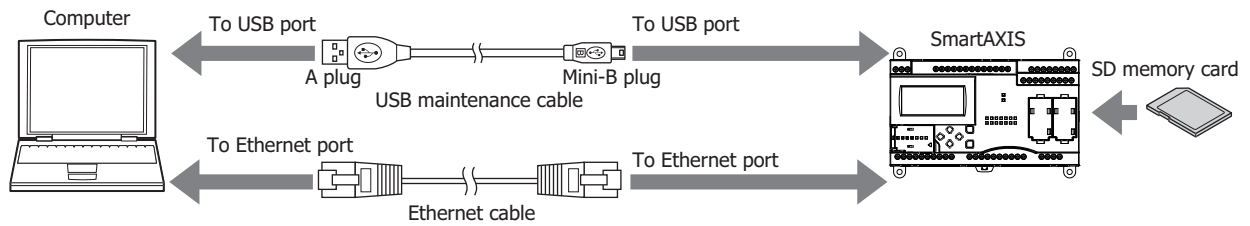

Notes:

- The Data File Manager cannot be used when an SD memory card is not inserted into the SmartAXIS.
- The Data File Manager cannot be used while the SmartAXIS is running.
- The Data File Manager uses the maintenance communication protocol of SmartAXIS, so it can be used only when the maintenance communication is possible. For example, the communication over Ethernet is not possible if the port number is different.
- The operating speed varies according to the state of communications with the SmartAXIS and the capacity of the SD memory card.
- The Data File Manager cannot perform certain operations such as downloading files, creating folders, and changing file names.
- The basic restrictions of SD memory cards and the file system are the same as the restrictions for the DLOG and the TRACE instructions/FB.

Starting the Data File Manager

Operation procedure

1. Select **Online > PLC > Maintenance > Data File Manager**.
The Data File Manager dialog box opens.

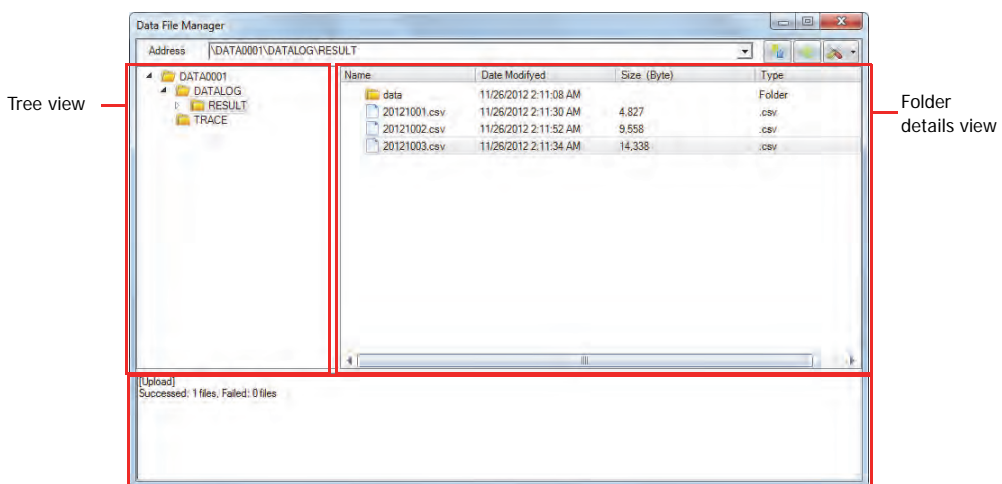
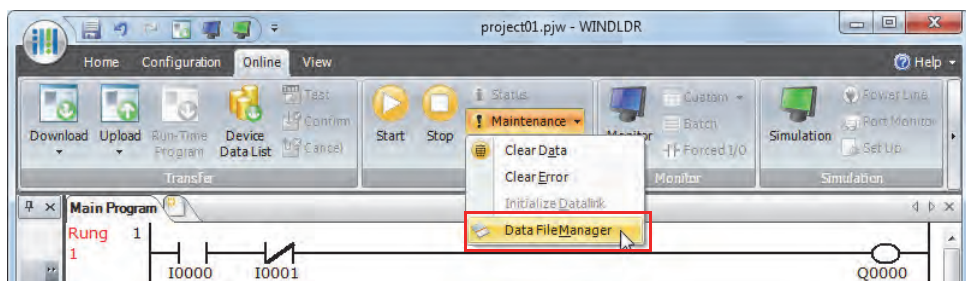

Execution log view

The execution log view shows the results of accessing and manipulating files and folders on the tree view and the folder details view.

5: SPECIAL FUNCTIONS

Exiting the Data File Manager

Operation procedure

1. Click **X** at the upper-right corner of the Data File Manager.
The Data File Manager exits.

Browsing folders

Operation procedure

1. In the address field, enter the folder path to the data.
The contents of the folder are displayed.

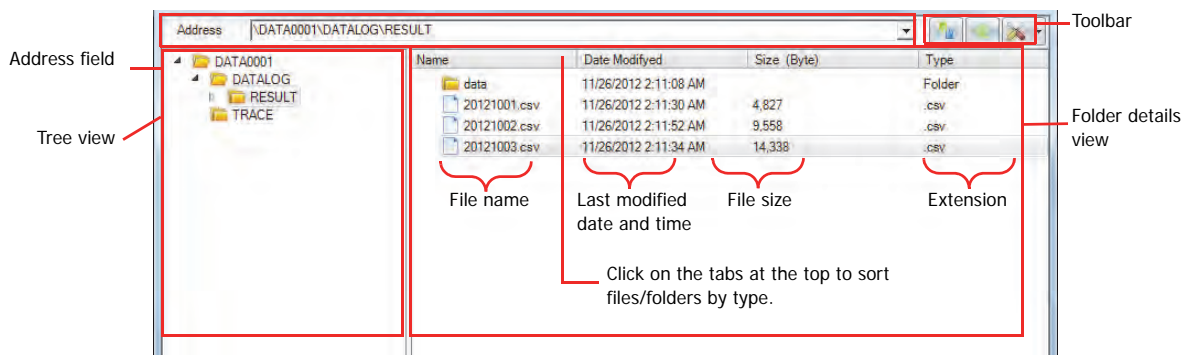

Click **Refresh** button on the toolbar to refresh the view with the latest status.

If you double click on a folder on the tree view or the folder details view in the Data File Manager, the contents of the folder are displayed.

Deleting files and folders

Operation procedure

1. On the details view, right click on a file or folder and select **Delete**.
2. On the delete confirmation dialog, click **Yes**.
The file or folder is deleted.

Uploading files

Operation procedure

1. Click **Upload** button on the toolbar.
A dialog box is displayed for you to enter the location to save the selected files.
2. Enter the location and click **OK**.
The files uploaded from the SD card is saved to the specified location.

Formatting the SD memory card

Operation procedure

1. Click **Tools** button on the toolbar.

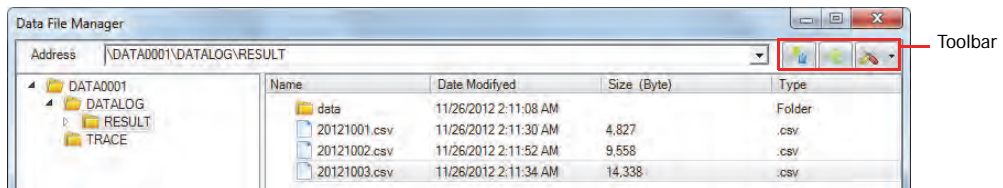

2. Select **Format SD Memory Card**.

A warning message is displayed. To execute the format, click **Yes**, and then the format will be executed.

Notes:

- The volume label given to the SD memory card when formatted is fixed as "IDEC_FT1A."
- Formatting the SD memory card on the SmartAXIS is equivalent to formatting it with the quick format option in Windows.

File Structure

The save destination for log data varies depending on the instruction/FB. For the DLOG (data log) instruction/FB, the files are saved under the DATALOG folder. For the TRACE (data trace) instruction/FB, the files are saved under the TRACE folder. The name of folder storing files is specified in the DLOG and the TRACE instructions/FB.

SD memory card

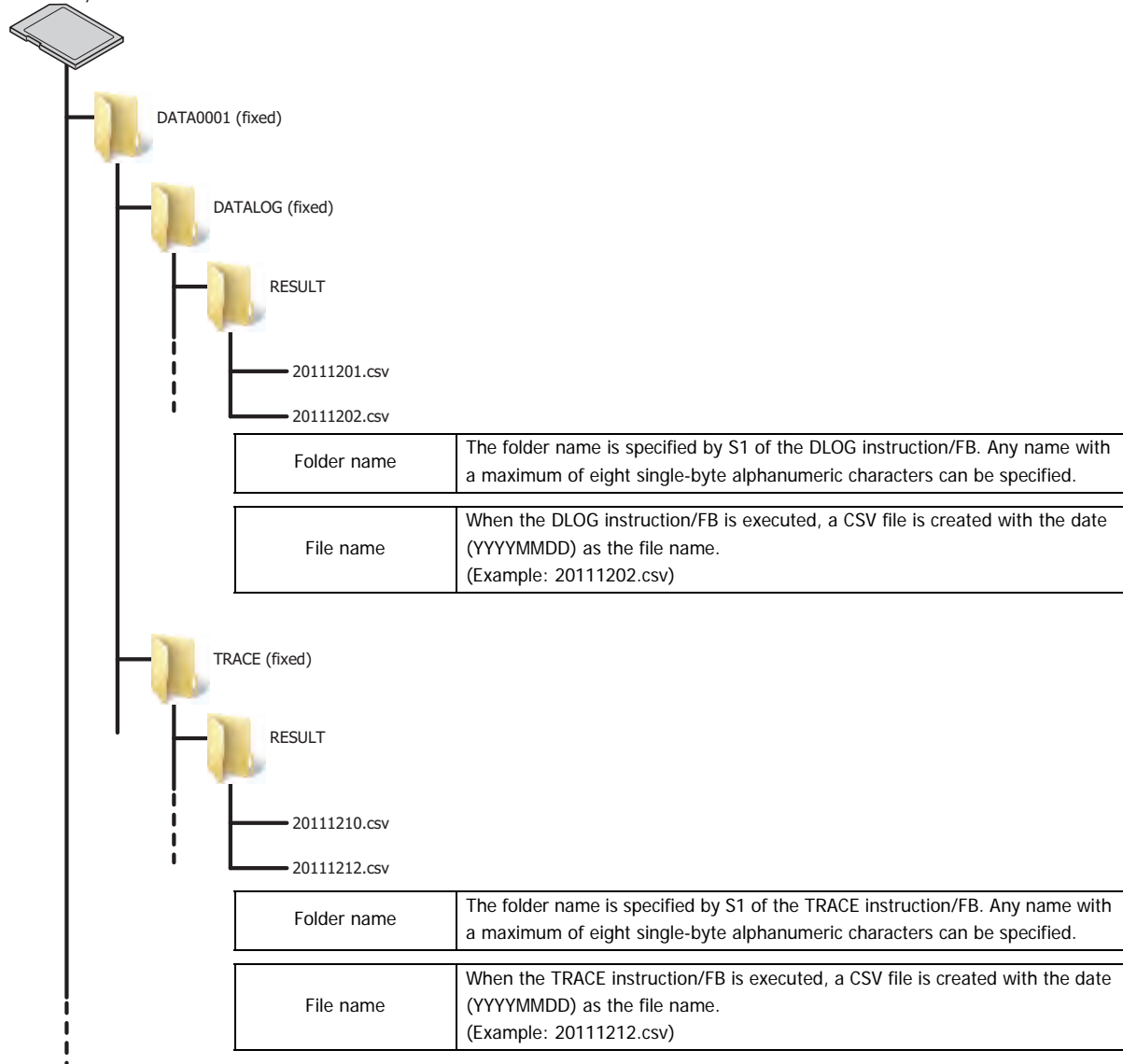

5: SPECIAL FUNCTIONS

SD Memory Card Status LED and SD Memory Card Status

The status LED turns on or flashes when the SD memory card is being formatted or during reading and writing.

SD memory card status LED	SD memory card state	Operation
On	The standby state where the SD memory card can be written or read	The SD memory card can be removed.
Slow flashing (1 second interval)	<ul style="list-style-type: none"> While the SmartAXIS is recognizing the SD memory card While the SmartAXIS is stopping the access due to SD memory card access stop flag (M8076) turning on (slow flashing, then off) 	Do not remove the SD memory card.
Quick flashing (100 millisecond interval)	Reading from or writing to the SD memory card	
Off	<ul style="list-style-type: none"> When an SD memory card is not inserted When an unsupported or unformatted SD memory card is inserted When access to the SD memory card is stopped by SD memory card access stop flag (M8076) When the SmartAXIS is turned off 	The SD memory card can be removed.

Special Internal Relays for the SD Memory Card

The special internal relays (M8026 and M8027) turn on and off according to the installation status and the access state of the SD memory card. Access to the SD memory card can be stopped by special internal relay M8076.

Address	Function	Description	Read/Write
M8026	SD Memory Card Status	This special internal relay turns on when the SD memory card has been inserted into the SmartAXIS, the card has been recognized, and the card is in a usable state. This special internal relay turns off when the SD memory card is not inserted or when the SD memory card is not recognized.	R
M8027	SD Memory Card Writing Flag	This special internal relay turns on when the SD memory card is being accessed. This special internal relay turns off when the access has finished.	
M8076	SD Memory Card Access Stop Flag	When this special internal relay changes from off to on, access to the SD memory card is stopped. Once the access to the SD memory card is stopped, insert the card into the SmartAXIS again to make it accessible.	R/W

Note: R/W is the abbreviation for read/write. R/W indicates that the relay can be read and written. R indicates that the relay can only be read. W indicates that the relay can only be written.

Timing Chart

The special internal relays turn on and off according to the installation status and the access state of the SD memory card as shown below.

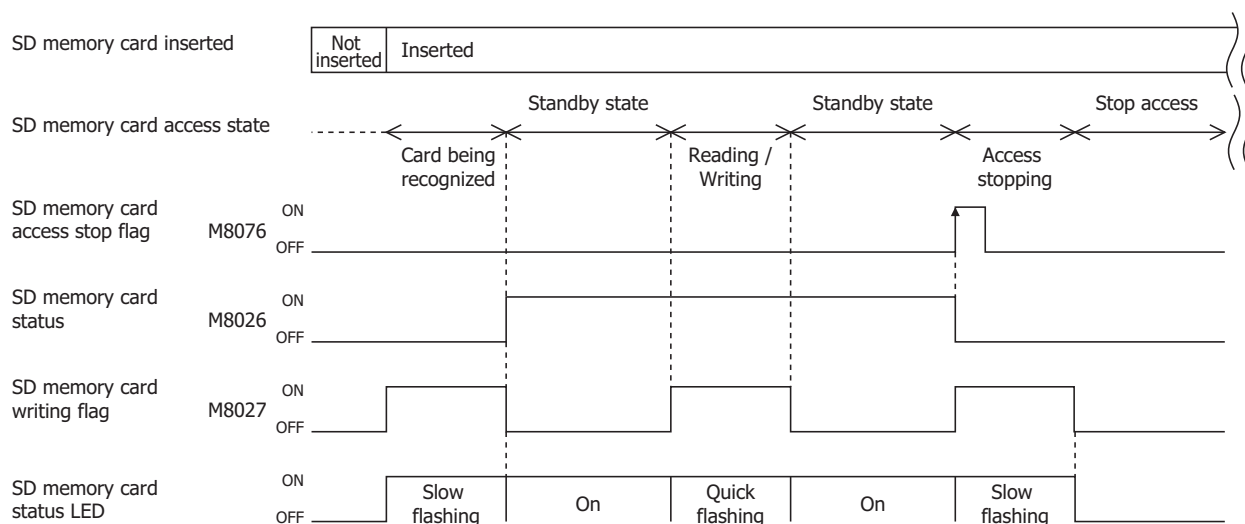

Backlight ON Time

This section describes the function to change the backlight ON time for the SmartAXIS Pro.

Function Specification

When you press operation buttons on the SmartAXIS Pro, the LCD backlight is turned on. The backlight is turned off automatically when there are no user operations. The backlight ON time can be configured with D8074 between 1 to 65,535 seconds. When the backlight ON time is 0, the backlight is always ON. The default value is 10 seconds and can be configured in the Function Area Settings dialog box of WindLDR.

Address	Description	Read/Write
D8074	Backlight ON Time	R/W

Notes

- The default value configured in the Function Area Settings is stored in D8074 once the user program downloaded is completed.
- If the backup battery is dead, the default value is stored in D8074.
- The backlight ON time can be configured with HMI function of SmartAXIS Pro. For details, see "Setting the LCD Backlight ON Time" on page 6-10.

Programming WindLDR

1. From the WindLDR menu bar, select **Configuration > LCD Settings**.
The Function Area Settings dialog box is displayed.

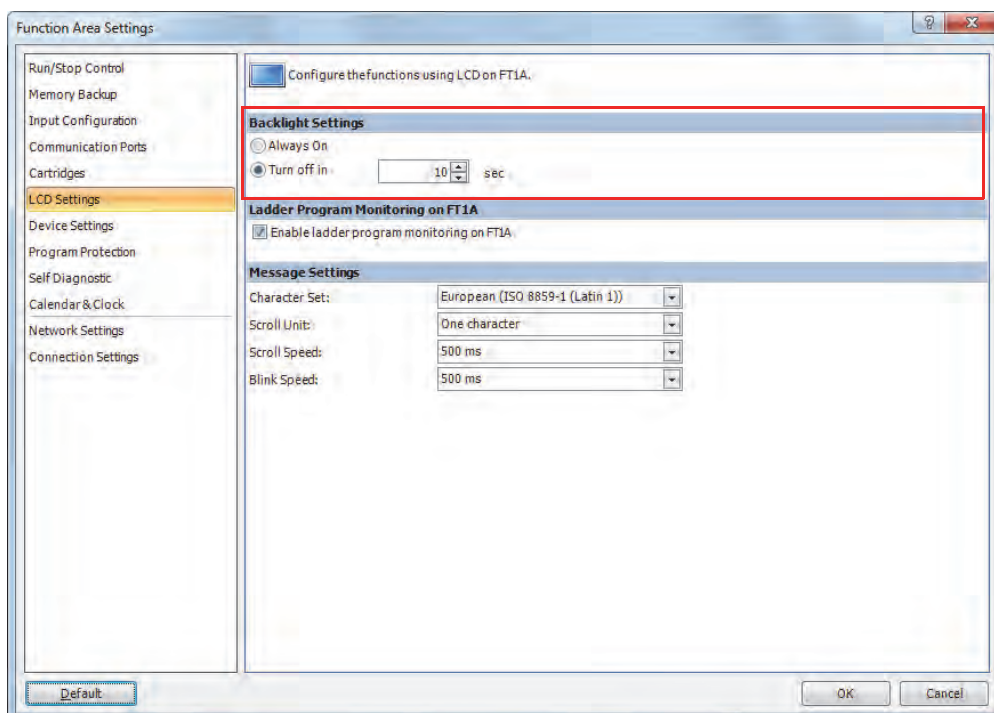

2. Select Always On or Turn off in in the backlight settings.
When you select Turn off in, enter the time period from the backlight is turned on until it is turned off. The time can be configured between 1 and 65,535 seconds in increments of 1 second.
3. Click the OK button.
This concludes configuring the settings.

Monitoring Ladder Program

This section describes the function to monitor the ladder program on the LCD of the SmartAXIS.

The program monitor on the SmartAXIS Pro is only enabled when ladder program is selected as the programming language.

Function Specification

Two lines of the ladder program stored in the ROM can be displayed on the LCD. You can show the ladder program at the specified line number by specifying it using the operation buttons. The SmartAXIS saves the monitored ladder line when ladder program monitoring is finished, and you can resume to monitor the ladder program from the same ladder line.

You can display the details of instruction parameters or switch the on/off state of contacts using the operation buttons.

The ladder program can be monitored regardless of the Run/Stop status of the SmartAXIS.

Notes:

- The default value of the previously monitored ladder line number is one.
- The previously monitored ladder line number is lost at the following conditions:
 - SmartAXIS Pro is powered up.
 - A user program is downloaded to the SmartAXIS Pro.

In order to monitor the ladder program on the LCD of the SmartAXIS Pro, you need to configure settings using WindLDR.

There are two restrictions in creating the ladder programs that can be displayed on the LCD. Create ladder programs considering those restrictions.

- A maximum of four ladder lines can be programmed in each ladder circuit.
- A maximum of eleven instructions can be programmed in each ladder line.

Programming WindLDR

■ Configuration at the start up of WindLDR

1. Launch WindLDR.

The Ladder Program Monitoring on FT1A dialog box is displayed.

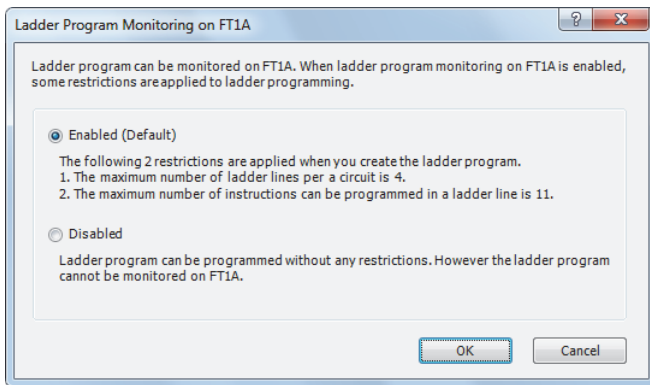

2. Select **Enabled (Default)** and click the **OK** button.

■ Configuration in the Function Area Settings

1. From the WindLDR menu bar, select **Configuration > LCD Settings**.
The Function Area Settings dialog box is displayed.

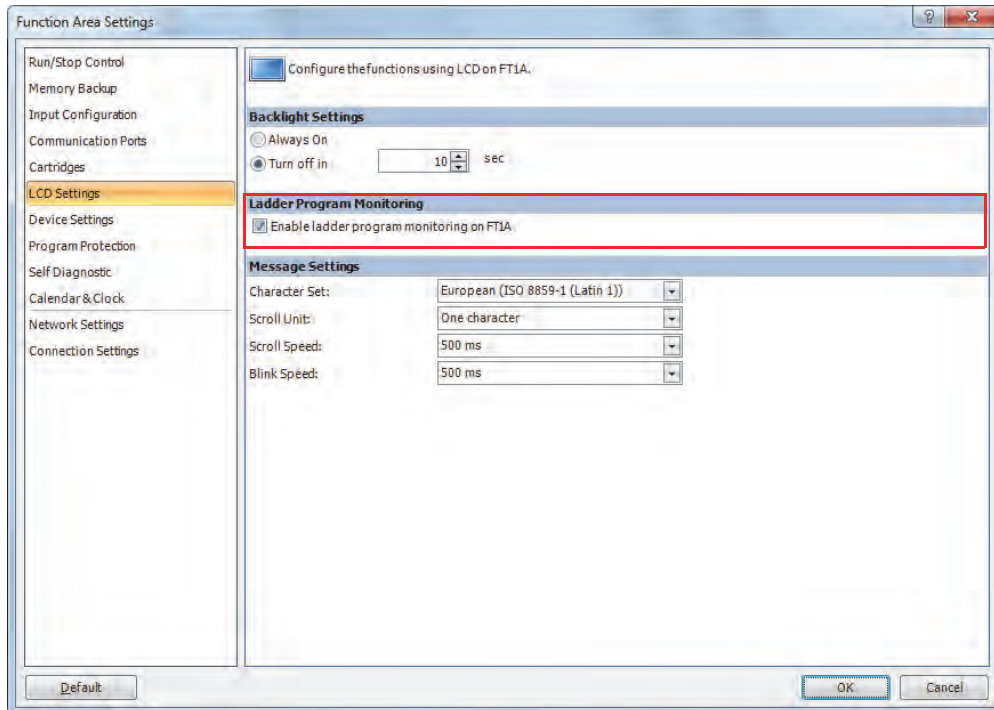

2. Select the **Enable ladder program monitoring on FT1A** check box.
3. Click the **OK** button.
This concludes configuring the settings.

Note: The setting you select in the Ladder Program Monitoring on FT1A dialog box at the start up of WindLDR can be changed in the Function Area Settings dialog box later.

Message Settings

The customized messages can be displayed on the LCD of the SmartAXIS Pro. This section describes the common settings, character set, scroll, and blinking settings, for all messages to display.

Function Specification

Any messages can be displayed on the LCD of the SmartAXIS Pro using MSG (Message) instructions/FB.

The character set, scroll unit, scroll speed, and blinking speed are the common settings between all MSG instructions/FBs programmed. Those common settings can be configured in the Message Settings of the Function Area Settings dialog box.

For details on the MSG instruction, see Chapter 13 "Display Instructions" in the SmartAXIS Ladder Programming Manual. For details on the MSG FB, see Chapter 14 "The interface FB" - "MSG FB Common Settings" in the SmartAXIS FBD Programming Manual.

■Character Set

The character set used for the messages can be configured.

Selection	Character Set	Languages usable in the MSG instruction/FB
European	ISO-8859-1 (Latin 1)	Italian, English, Dutch, Spanish, German, French
Japanese	Shift-JIS	Japanese
Chinese	GB2312	Chinese (simplified)
Cyrillic	ANSI 1251	Russian

■Scroll Unit

The unit to scroll the texts can be configured.

1 character	Scrolls the text in 1 character units.
1 dot	Scrolls the text in 1 dot units.

■Scroll Speed

The speed to scroll the texts can be configured. The setting range is 500 to 1000 ms.

■Blinking Speed

The speed to blink the texts can be configured. The setting range is 500 to 1000 ms.

Programming WindLDR

1. From the WindLDR menu bar, select **Configuration > LCD Settings**.
The Function Area Settings dialog box is displayed.

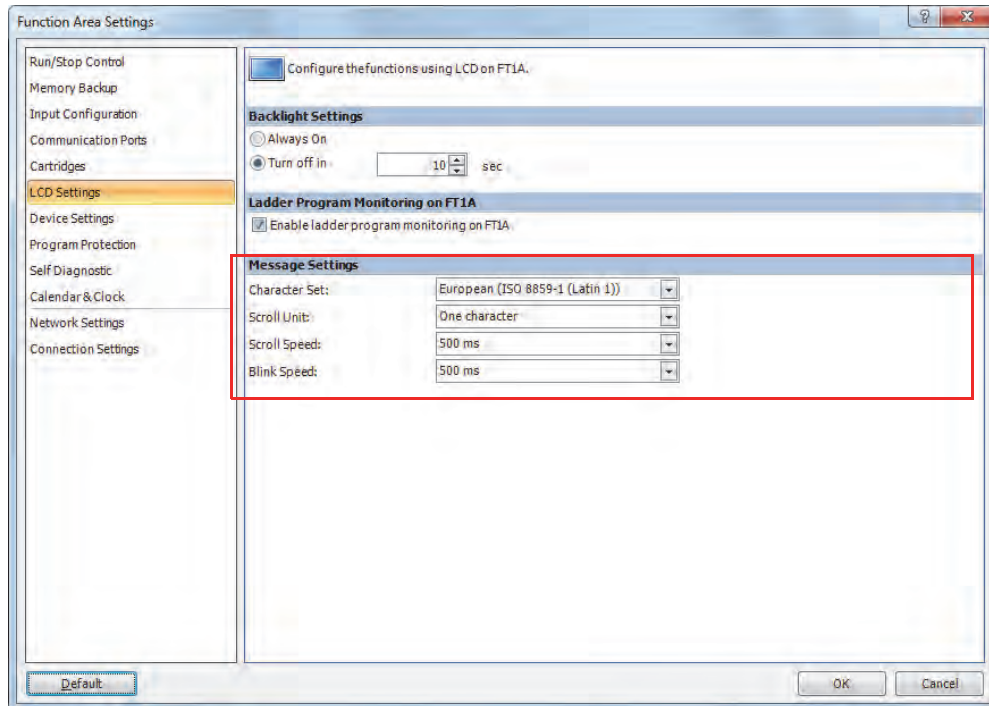

2. Configure the character set, scroll unit, scroll speed, and blinking speed in the message settings.
3. Click the **OK** button.
This concludes configuring the settings.

32-bit Data Storage Setting

When the double-word, long, or float data type is selected for the source or destination device, the data is loaded from or stored to two consecutive data registers. The order of the two devices can be selected from the following two settings in the Function Area Settings.

Setting	Description
From Upper Word (Default)	When a data register, timer, or counter is used as a double-word device, the high-word data is loaded from or stored to the first device selected. The low-word data is loaded from or stored to the subsequent device. This is identical with the 32-bit data storage of OpenNet Controller and FC4A/FC5A MicroSmart.
From Lower Word	When a data register, timer, or counter is used as a double-word device, the low-word data is loaded from or stored to the first device selected. The high-word data is loaded from or stored to the subsequent device.

Devices

When the devices listed below are used as a double-word device, two consecutive devices are processed according to the 32-bit data storage settings.

Device	Device Address
Data Register	D0 - D1999
Special Data Register	D8000 - D8199
Timer	T0 - T199
Counter	C0 - C199

Data : The following data composed of 32 bits is subject to this setting.

- Device values of advanced instructions/FB with the data processing units D (double word), L (long), F (float)
- Pulse output preset values and current values
- High-speed counter function current values, preset values, and reset values
- Frequency measurement values in frequency measurement
- Double word counter instruction/FB preset values

Programming WindLDR

1. From the WindLDR menu bar, select **Configuration > Device Settings**.
The Function Area Settings dialog box for Device Settings appears.

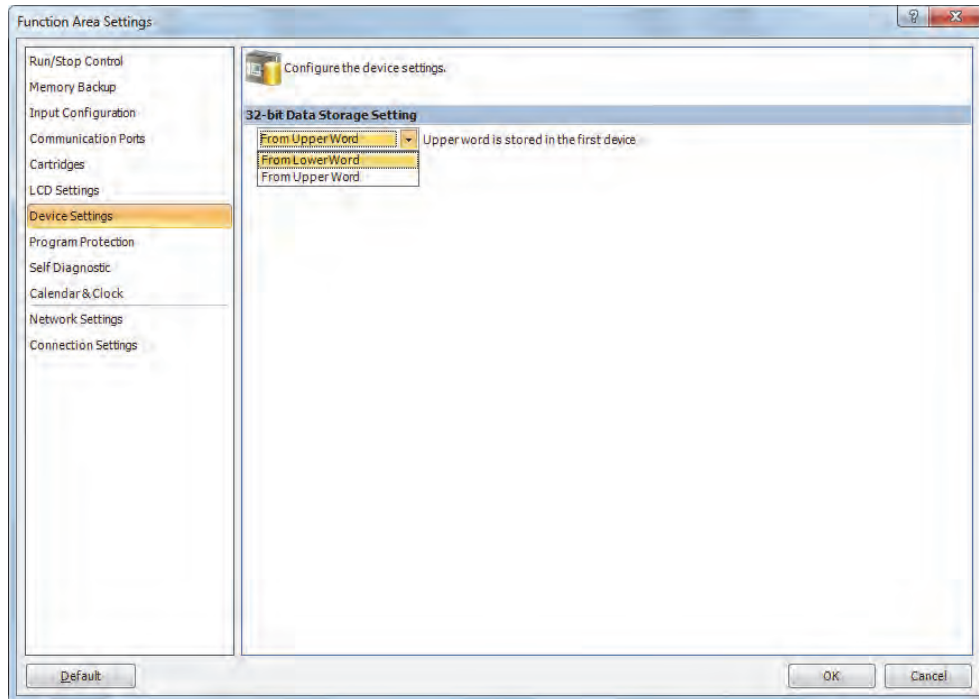

2. Under **32-bit Data Storage Setting**, select **From Upper Word** or **From Lower Word** in the pull-down list.

Example: 32-bit Data Storage Setting

When data register D10 is designated as a double-word source device and data register D20 is designated as a double word destination device, the data is loaded from or stored to two consecutive devices according to the 32-bit data storage setting as illustrated below.

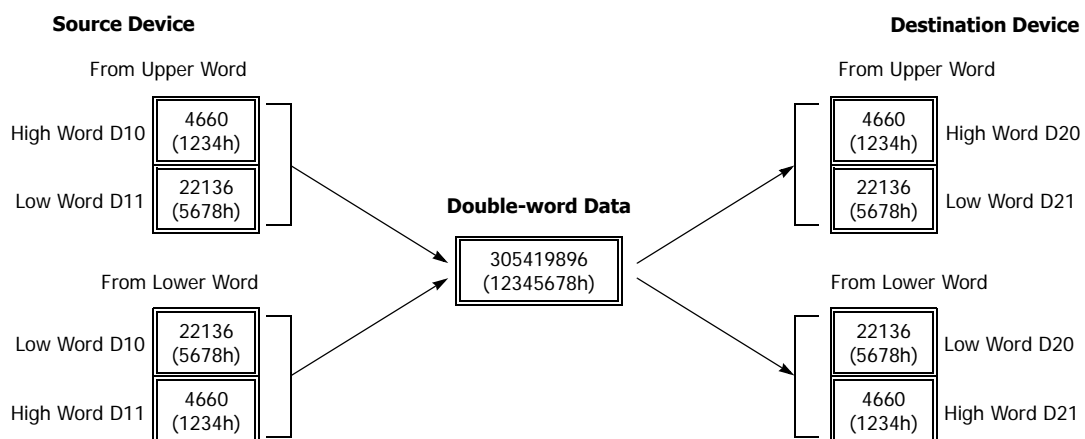

User Program Protection

With user program protection, you can apply protection against user program editing by using the LCD and operation buttons on the SmartAXIS module (SmartAXIS Pro only) and against uploading and downloading user programs with WindLDR. This enables you to prevent third parties from altering, deleting, or stealing your SmartAXIS user programs.

User program protection can be individually configured for user program uploads and downloads and for editing user programs with the LCD and operation buttons on the module. There are three types of protection modes, which are detailed as follows:

Mode	Description
Unprotected	The user program is unprotected.
Password protected	A password must be entered when downloading or uploading the user program. The password is single-byte alphanumeric characters (8 characters max), and one password can be configured for one user program. When applying password protection to both user program uploads and downloads, the same password is used.
Prohibited	The user program cannot be uploaded. Prohibited protection can only be configured for user program uploads. User program downloads cannot be prohibited.

If the user program is protected, you will be prompted to enter your password when executing a download or an upload. The download or upload can be executed by entering the correct password.

Note: Protection is also enabled when transferring user programs between the memory cartridge and the SmartAXIS.

For the SmartAXIS Lite, the password for the user program on the memory cartridge and the password for the user program on the SmartAXIS must match. For the SmartAXIS Pro, the password must be entered with the LCD and operation buttons on the module.

Note:

- Before proceeding with the following steps, make sure to note the protect code, which is needed to disable the user program protection. If the user program in the SmartAXIS is write- or read/write-protected, the user program cannot be changed without the protect code.
- If the user program is read-protected without using a password, the read protection cannot be temporarily disabled using the password, thus the user program cannot be read out by any means. To disable the read protection, download another user program without user program protection.

Programming WindLDR

1. From the WindLDR menu bar, select **Configuration > Program Protection**.

The Function Area Settings dialog box for Program Protection appears.

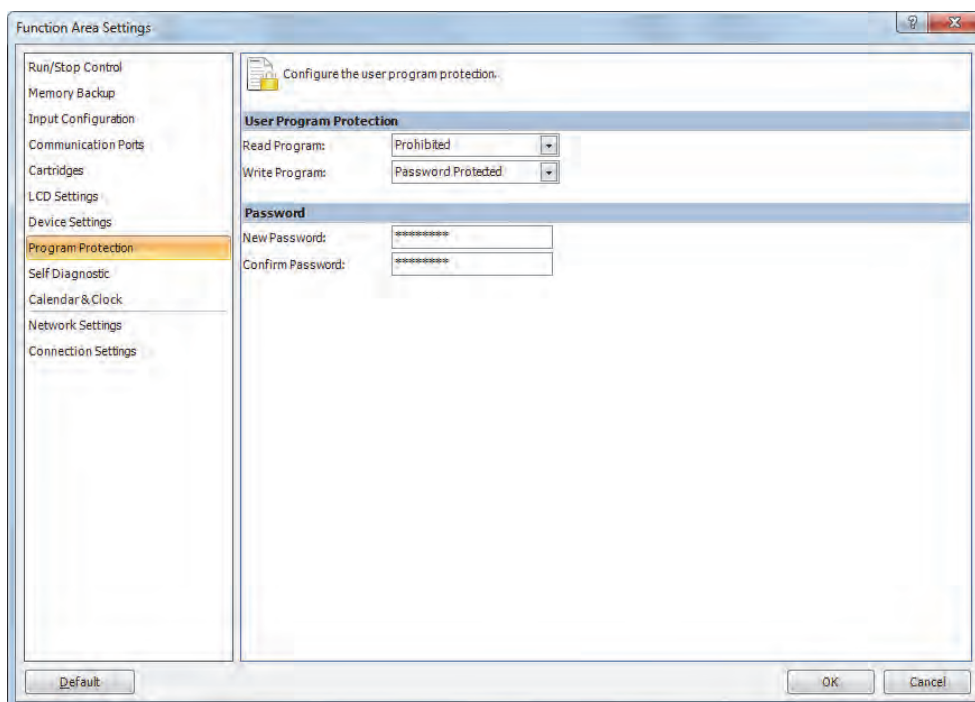

- Under **User Program Protection**, select required protect modes for **Read Program** and **Write Program** in the pull-down list.

Unprotected:	The user program in the SmartAXIS can be read and written without a password.
Password Protected:	Prevents unauthorized copying or inadvertent replacement of the user program. This protection can be temporarily disabled using a predetermined password.
Prohibited:	Prevents copying of the user program completely. This option is available for read protection only and can not be temporarily disabled using a password.

- After selecting a required protect mode, enter a password of 1 through 8 ASCII characters from the key board in the **New Password** field, and enter the same password in the **Confirm Password** field.
- Click the **OK** button and download the user program to the SmartAXIS after changing any of these settings.

Disabling Protection

When the user program is password-protected against read and/or write, the protection can be temporarily disabled using WindLDR.

If the user program is read-prohibited, the read protection cannot be disabled, thus the user program cannot be read by any means. To disable the read protection, download another user program without user program protection.

- From the WindLDR menu bar, select **Online > Download or Upload**.

When the user program in the SmartAXIS is read and/or write protected, the Protect Error dialog box appears. When program verification or online edit is attempted, the Protect Error dialog box appears.

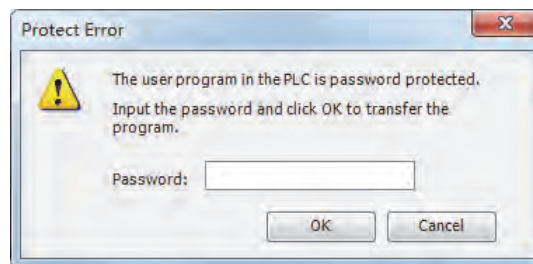

- Enter the password and click the **OK** button.
The user program protection is disabled only temporarily. When the SmartAXIS is powered up again, the protection designated in the user program takes effect again.
To disable or change the protection permanently, change the protection settings and download the user program.

Watchdog Timer Setting

This section describes watchdog timer setting.

A watchdog error occurs when the processing time for one scan exceeds the allowed time while the user program is running.

If a watchdog error occurs, the system is reset with the purpose of returning the system to normal operation.

If the watchdog error occurs frequently, you can assume that there is a hardware problem and that the SmartAXIS requires replacement.

Some of the reasons why a watchdog timer will occur are problems with the SmartAXIS hardware and length of the processing time in the program. If the processing time for one scan of the ladder program exceeds the time configured for the watchdog timer on the ladder program, place an NOP (no operation) instruction in the ladder program. The watchdog timer is reset when the NOP instruction is executed.

For FBD, the watchdog timer cannot be reset in the program.

Watchdog timer setting time

The watchdog timer setting time can be changed in the function area settings. Decide on the watchdog timer setting time in either of the following two ways.

- **Decide by user system specification**

Determine the maximum on time (milliseconds) so the output signals do not stay on if the SmartAXIS loses control and set that value as the watchdog timer setting time. However, if the ladder program processing time takes longer than the design specification, use an NOP (no operation) instruction in the ladder program. For example, when the watchdog timer is set to 100ms and the maximum value for one scan is 120ms on the ladder program, insert an NOP instruction in the ladder program to ensure that the error does not occur.

- **Match the program processing time**

Check the maximum value for one scan (D8024) and set the watchdog timer value as a value with a safety margin added to the maximum value.

Note: When changing the watchdog timer setting value, select an appropriate value that fully takes into consideration the safety of the system.

The maximum value of one scan while the SmartAXIS is running can be checked with special data register D8024.

Programming WindLDR

1. Select **Configuration** from the WindLDR menu bar, and then click **Self Diagnostic**.

The Function Area settings dialog box appears.

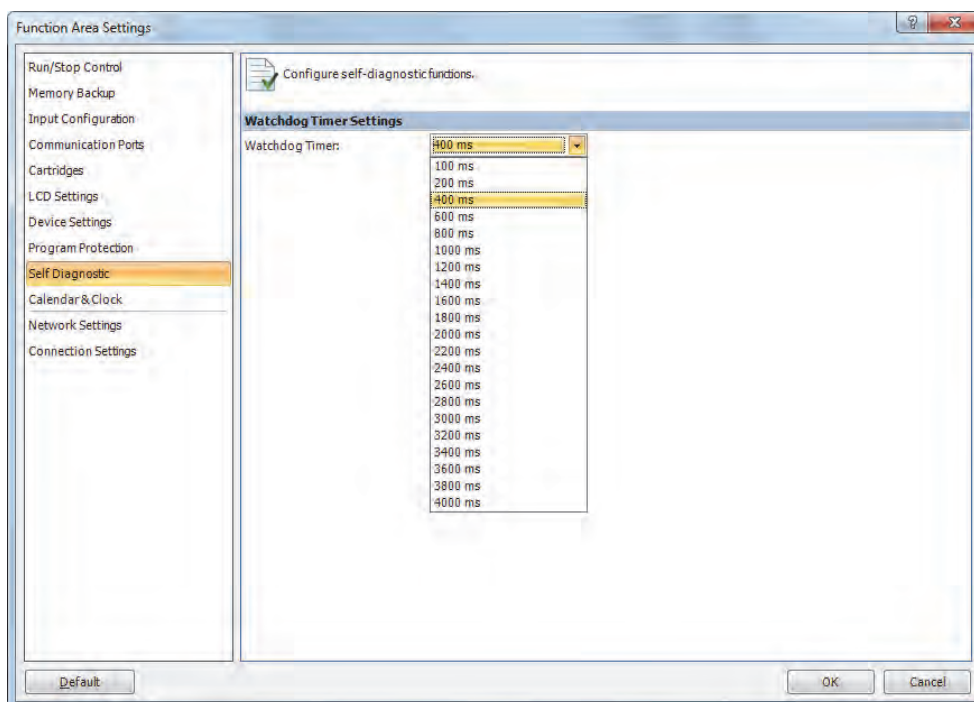

Watchdog Timer Settings

Select the watch dog timer setting between 100ms and 4000ms. The default time is 400ms.

Constant Scan Time

The scan time may vary whether basic and advanced instructions/FB are executed or not depending on input conditions to these instructions/FBs. The scan time can be made constant by entering a required scan time preset value into special data register D8022 reserved for constant scan time. When performing accurate repetitive control, make the scan time constant using this function. The constant scan time preset value can be between 1 to 1,000ms.

The scan time error is ± 1 ms of the preset value normally. When the data link or other communication functions are used, the scan time error may be increased to several milliseconds.

When the actual scan time is longer than the scan time preset value, the scan time cannot be reduced to the constant value.

Special Data Registers for Scan Time

In addition to D8022, three more special data registers are reserved to indicate current, maximum, and minimum scan time values.

Note: R/W is the abbreviation for read/write. When R/W, it can be read and written. When R, it can only be read. When W, it can only be written.

D8022	Constant Scan Time Preset Value (1 to 1,000ms)
D8023	Scan Time Current Value (ms)
D8024	Scan Time Maximum Value (ms)
D8025	Scan Time Minimum Value (ms)

Example: Constant Scan Time

This example sets the scan time to a constant value of 500 ms.

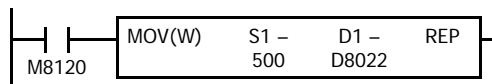

M8120 is the initialize pulse special internal relay.

When the SmartAXIS starts operation, the MOV (move) instruction stores 500 to special data register D8022.

The scan time is set to a constant value of 500ms.

Daylight Savings Time

This section describes the function that automatically adjusts the SmartAXIS time according to daylight savings time settings.

For regions where the SmartAXIS is used that implement daylight savings time, this function can automatically adjust the SmartAXIS clock using the daylight savings time settings. When the time reaches the daylight savings start time, the clock is set an hour forward. When the time reaches the the daylight savings time end, the clock is set an hour back.

The SmartAXIS adjusts the clock for daylight savings time on the start day and the end day. However, the clock is also adjusted for daylight savings time under the following conditions.

- When a user program was downloaded to the SmartAXIS.
- When the SmartAXIS power was turned on.

When the current time of the SmartAXIS' internal clock is set using WindLDR or the operator interface, the time is not adjusted for daylight savings time, even if the time after it was set is within the daylight savings time period. Set the time to the time adjusted for daylight savings time. The set date and time becomes the date and time after being adjusted for daylight savings time.

Programming WindLDR

Configure daylight savings time on the SmartAXIS.

1. From the WindLDR menu bar, select **Configuration > Calendar & Clock**.
The Function Area Settings dialog box is displayed.
2. Select the **Enable daylight savings time** check box.

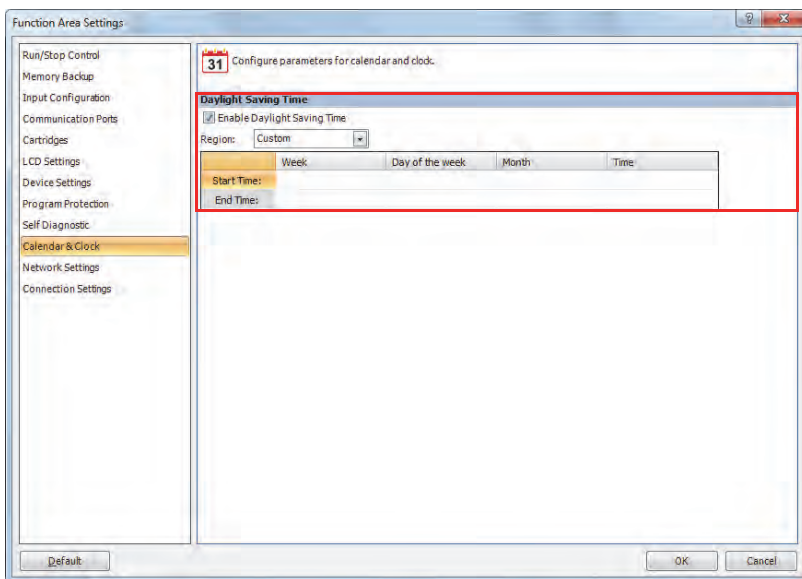

3. Configure the start time and the end time. Specify the region using the **Region** list box.
If you select **Custom**, you are able to select any desired start time and end time.

Region	Start time	End time
Custom	User specified	User specified
USA or Canada	March, 2nd Sunday, 2:00 AM	November, 1st Sunday, 2:00 AM
Europe	March, last Sunday, 1:00 AM	October, last Sunday, 1:00 AM
Australia	October, 1st Sunday, 2:00 AM	April, 1st Sunday, 3:00 AM

4. Click **OK**.
This concludes configuring the settings.

Clock Function

This section describes the internal clock function on the SmartAXIS.

This function enables you to control the time schedule for lighting or air conditioning equipment using the current time data stored in special data registers. The internal clock data is backed up by a secondary lithium battery. The current time is reset when the backup data is lost, so the current time will need to be set again.

Function	Description
Read clock	The current time (calendar, clock) is updated every 500 ms and automatically stored in the special data registers.
Set clock	Sets the current time (calendar, clock). Set the current time with WindLDR or a user program that uses the special data registers.
Adjust function	When clock data adjust flag M8021 is turned on from off, the seconds for the current time are rounded up or rounded down based on 30 seconds to correct the seconds data for the internal clock. If the current seconds are between 0 and 29 seconds, the seconds are set to 0 when M8021 is turned on from off. If the current seconds are between 30 and 59 seconds, the minutes are set to + 1 and the seconds are set to 0 when M8021 is turned on from off.
Calendar/clock error	M8013: This relay turns on if clock write processing or a clock adjust processing could not be executed normally. M8014: This relay turns on if an error occurs while calendar/clock data is read from the internal clock to the special data registers (D8008 to D8014).

Setting the Clock with WindLDR

Set the current time on the SmartAXIS with WindLDR.

1. From the WindLDR menu bar, select **Online > Monitor > Monitor**.
WindLDR enters monitor mode.
2. Select **Online > PLC > Status**.
The PLC Status dialog box is displayed.
3. Click **Change** for **Calendar**.
The Calendar Settings dialog box is displayed. The current time on the computer is displayed in the dialog box as the initial value. The settings can also be changed as necessary.

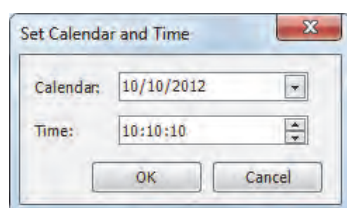

4. Click **OK**.
The date and time configured in the dialog box is written to the SmartAXIS.

5: SPECIAL FUNCTIONS

Setting the Clock with a User Program

A user program can write the clock data from an operator interface without using WindLDR by using special data registers D8015 to D8021. Undefined values are stored in special data registers D8015 to D8021. Always store an appropriate value before turning on M8016, M8017, or M8020.

Calendar Data Write Flag (M8016)

After writing data to the write calendar special data registers (D8015 to D8018), turn M8016 off to on to set the internal clock with the data in D8015 to D8018 as the calendar data (year, month, day, day of the week).

Clock Data Write Flag (M8017)

After writing data to the write clock special data registers (D8019 to D8021), turn M8017 off to on to set the internal clock with the data in D8019 to D8021 as the clock data (hour, minute, second).

Calendar/Clock Data Write Flag (M8020)

After writing data to the write calendar/clock special data registers (D8015 to D8021), turn M8020 off to on to set the internal clock with the data in D8015 to D8021 as the calendar data (year, month, day, day of the week) and the clock data (hour, minute, second).

Calendar and clock data storage locations

The calendar/clock data is stored in the following special data registers.

Special data register	Description	Range	Setting timing
D8008	Calendar/Clock Current Data (Read only)	Year	Every 500 ms (Note)
D8009		Month	
D8010		Day	
D8011		Day of the week	
D8012		Hour	
D8013		Minute	
D8014		Second	
D8015	Calendar/Clock New Data (Write only)	Year	—
D8016		Month	
D8017		Day	
D8018		Day of the week	
D8019		Hour	
D8020		Minute	
D8021		Second	

Note: If the scan time is 500 ms or longer, D8008 to D8014 are updated with each scan.

For the day of the week data, the values below are stored in the special data registers.

Day of the week	Sunday	Monday	Tuesday	Wednesday	Thursday	Friday	Saturday
Value	0	1	2	3	4	5	6

Example ladder program 1

This example sets the calendar and clock in a user program.

If you turn on M8020 with the new calendar/clock data set in the write-only data registers D8015 to D8021, the internal clock on the SmartAXIS is updated with the current time (calendar, clock). In this example, the SmartAXIS internal clock is set to 9:35:00 on Tuesday February 21, 2012.

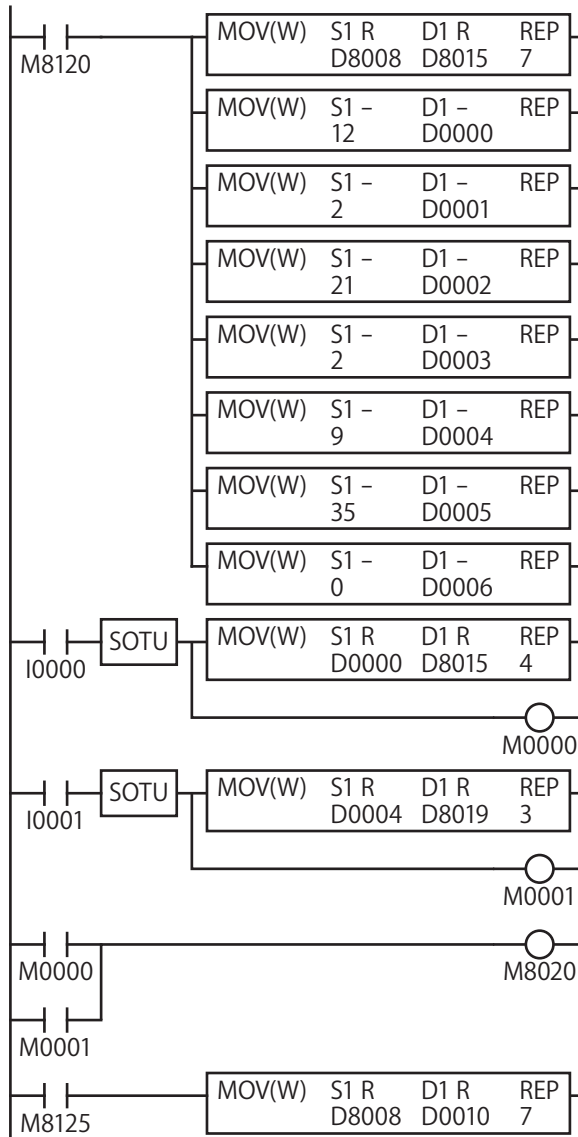

M8120 is the initial pulse that turns on for only one scan at the start of operation.
When the SmartAXIS starts operating, the current calendar/clock data is stored in D8015 to D8021 and the new calendar/clock data is stored in D0 to D6 with the MOV (move) instruction.

When external input I0 turns on, the new calendar data is stored in special data registers D8015 to D8018.
Internal relay M0 turns on for one scan only.

When external input I1 turns on, the new clock data is stored in special data registers D8019 to D8021.
Internal relay M1 turns on for one scan only.

When external input M0 or M1 turns on, M8020 turns on and the calendar/clock data is written to the internal clock.
(M8020: Calendar/Clock Data Write Flag)

M8125 is a special internal relay that is always on during operation.
While the SmartAXIS is running, the current time (calendar, clock) is stored in D10 to D16 with the MOV instruction.

Example ladder program 2

When I1 turns off to on, the seconds on the internal clock are corrected to 0 seconds.

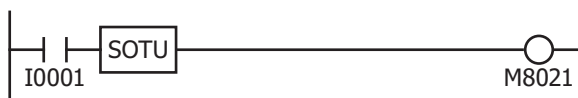

When input I1 turns on, clock data adjust flag M8021 turns on to correct the seconds on the internal clock.

Note: The internal clock backup time is approximately 30 days (25°C TYP). If the power loss time exceeds the backup time, the retained clock data is lost and the current time is initialized as 00:00:00 on January 1, 2000.

Network Settings

This section describes the network settings of the SmartAXIS.

These settings are used to configure the network to use the SmartAXIS Ethernet port. All SmartAXIS models are equipped with an Ethernet port except for the 12-I/O type. Configure the SmartAXIS network settings in the same manner as the network settings for a computer.

The network settings can be configured with either of the methods below.

- Automatically acquire an IP address (DHCP)
A DHCP server must be present on the network where the SmartAXIS is located. The SmartAXIS automatically acquires its network settings from the DHCP server. The network settings are acquired from the DHCP server when the user program is finished downloading and when the SmartAXIS is turned on.
- Use the following IP address
Enter the SmartAXIS network settings as a fixed IP address, subnet mask, and default gateway. The network settings are applied when the user program is finished downloading. Consult the network administrator regarding the IP address to configure.

Note 1: The SmartAXIS default settings are: IP address 192.168.1.5, subnet mask 255.255.255.0, default gateway 0.0.0.0.

Note 2: When automatically acquiring an IP address using DHCP, the same IP address may not be assigned each time depending on the DHCP server settings and the system configuration on the network where the SmartAXIS is operating. (Example: When using DHCP with two SmartAXIS and automatically acquiring the IP addresses, the IP addresses for two SmartAXIS may be replaced.) When the SmartAXIS is incorporated in a system configuration where it is a communication target, we recommend setting a fixed IP address, subnet mask, and default gateway.

Programming WindLDR

1. Select **Configuration** from the WindLDR menu bar, and then click **Network Settings**.
The Function Area settings dialog box appears.

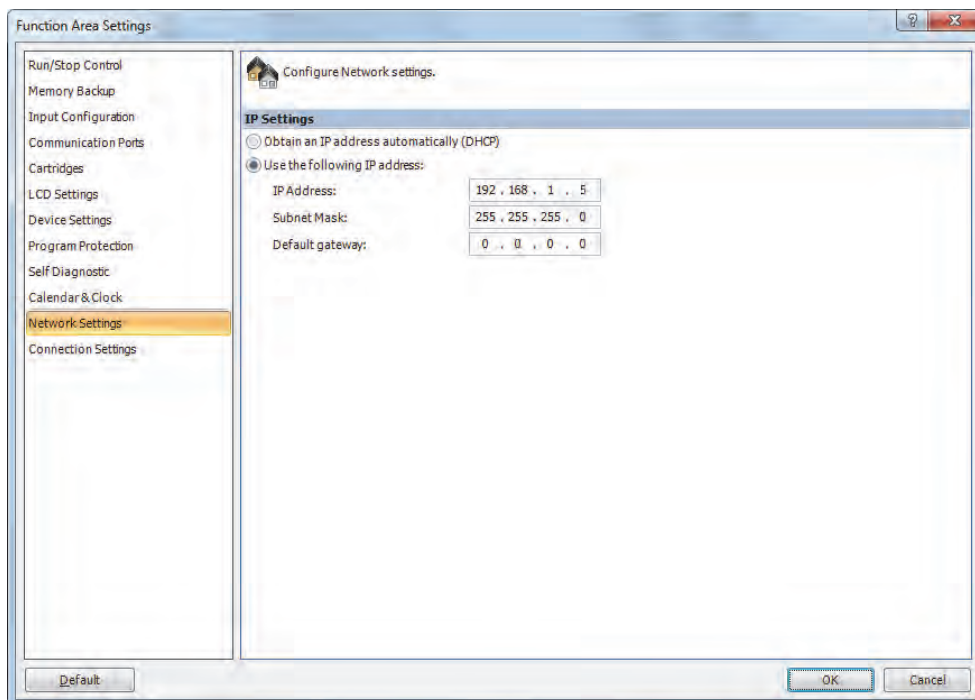

2. Select **Obtain an IP address automatically (DHCP)** or **Use the following IP address**.
When **Use the following IP address** is selected, enter the IP address, subnet mask, and default gateway.
3. Click **OK**.
This concludes configuring the settings.

Connection Settings

This section describes the configurations of the SmartAXIS module for client/server connections..

Applications

The SmartAXIS supports Ethernet communication functions with a maximum of three connections. Using those connections, maintenance communication, Modbus TCP communication, user communication, and remote I/O communication can be used. Those communications can be configured in the Function Area Settings dialog box.

Description of functions

The SmartAXIS has a maximum of three connections for the maintenance communication server, user communication server, Modbus TCP communication server, user communication client, Modbus TCP communication client and remote I/O master.

To limit the access to the SmartAXIS, IP address flittering can be used. By specifying the IP address that can access the SmartAXIS, anonymous access can be prevented.

Connection Status and Connected IP Address

The connection status of connections with remote hosts can be confirmed with special internal relays M8110 to M8112. When a connection with a remote host is established, the corresponding special internal relay is turned on. When the connection is disconnected, the corresponding special internal relay is turned off. The IP addresses of the remote hosts can be confirmed with special data registers D8110 to D8121.

Note: R/W is the abbreviation for read/write. When R/W, it can be read and written. When R, it can only be read. When W, it can only be written.

Special Internal Relays

Device Address	Description	Details
M8110	Connection 1 Status	While a connection is established with a remote host, the special internal relay will be on. When no connection is established, it will be off.
M8111	Connection 2 Status	
M8112	Connection 3 Status	

Special Data Registers

Device Address	Description	Details
D8110-D8113	Connection 1 Connected IP Address	IP address is stored in the corresponding special data registers. For example, when the IP address is aaa.bbb.ccc.ddd, each value is stored as follows: D8110=aaa, D8111=bbb, D8112=ccc, and D8113=ddd.
D8114-D8117	Connection 2 Connected IP Address	
D8118-D8121	Connection 3 Connected IP Address	

Programming WindLDR

1. From the WindLDR menu bar, select **Configuration > Connection Settings**.
The Function Area Settings dialog box is displayed.
2. Select **Communication Mode** for the connection to use.

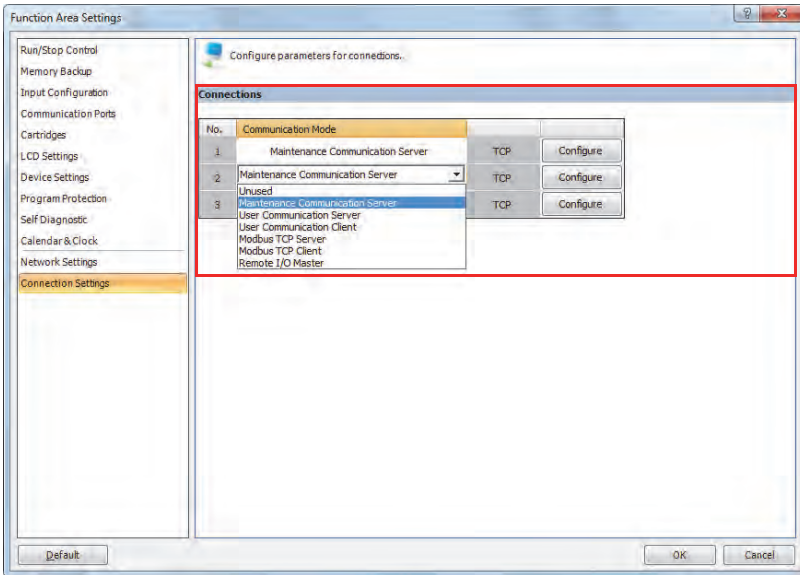

Configure the communication mode allocated to a maximum of three connections that can be used as client or server. Each connection can be set to a different port number. Set connections that are not used to **Unused**.

3. Select **Maintenance Communication Server**.
The Maintenance Communication Server dialog box is displayed.

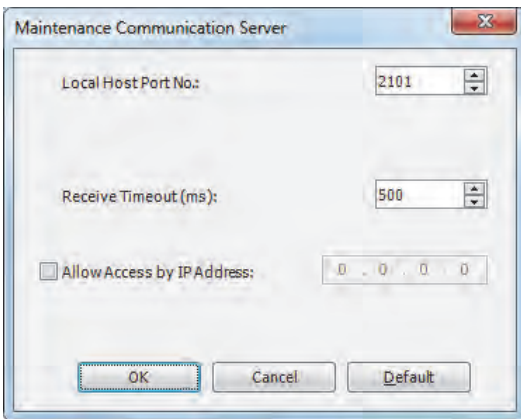

4. Specify the parameters.
Click **OK**.
This concludes configuring the settings.

Remote Host List

This chapter describes how to configure a list of network devices (remote hosts) in the network to which the SmartAXIS communicates.

Applications

When the SmartAXIS accesses and communicates with other network devices in the network, the remote host device should be specified. The remote host list is required to use the following functions:

- ETXD/ERXD Instructions (User communication over Ethernet)
- Modbus TCP Client
- Remote I/O Master

Description of Functions

The remote host consists of an **IP Address** or a **Host Name** and a **Port Number**.

When a remote host is specified with an IP address, and the SmartAXIS establishes connection with the remote host that has the specified IP address and the corresponding port number, then communication is started.

When a remote host is specified with a host name, the SmartAXIS tries to obtain the IP address from the specified host name using the DNS server. If the IP address is successfully obtained, the SmartAXIS establishes connection with the remote host that has the specified IP address and the corresponding port number, then communication is started.

For details about DNS server settings, see Network Settings in the Function Area Settings.

Programming WindLDR

1. Double-click on the Remote Host List in the **Project Window**.
The Remote Host List dialog box appears.

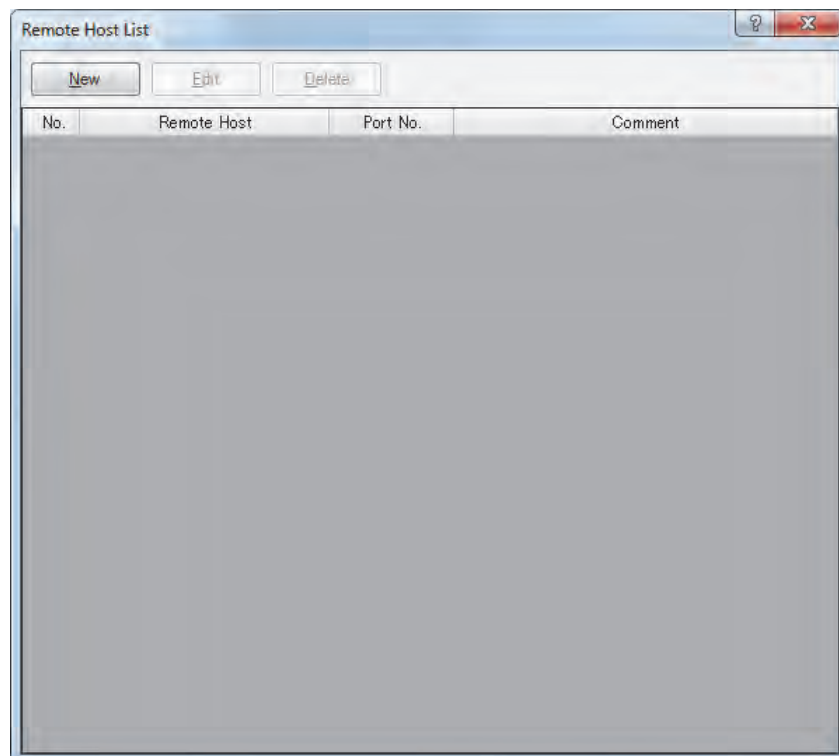

5: SPECIAL FUNCTIONS

2. Click **New** button or select an existing remote host and click **Edit** button.
The Remote Host dialog box appears.

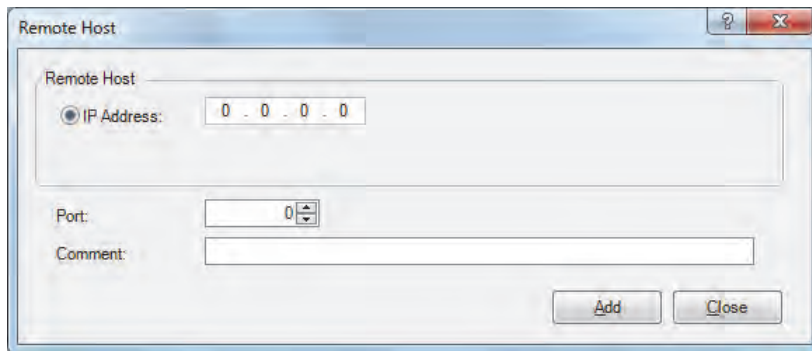

IP Address: Specify the remote host with an IP address.

Port Number: Specify the port number of the remote host. This port number is the TCP communication port number. It differs from the SmartAXIS USB port number (port 1) and the expansion communication port numbers (port 2, 3).

Comment: The comment for the remote host can be assigned. The contents or the length of the comment has no effect on the SmartAXIS operation.

3. Configure the parameters in the Remote Host dialog box and then click on **Add** button.
A new remote host will be added in the Remote Host List dialog box. If you want to add additional remote hosts, repeat the same procedure. After adding remote hosts has been completed, click on **Close** button.
4. If you want to delete an unused remote host, select that remote host in the Remote Host List dialog box and click on **Delete** button.
Once a remote host is deleted, the remote host numbers of the following remote hosts are changed. As a result, the functions referring to those remote hosts, such as Modbus TCP client, or User communication client, will be affected,

6: HMI FUNCTION

Introduction

You can run and stop the user program, monitor device values, and modify settings on the SmartAXIS Pro by using the LCD and operation buttons on the SmartAXIS. This chapter describes how to modify the user program and device values with the operation buttons.

Function Description

The following functions can be used with SmartAXIS button operations.

Type	Function		Description
Run/stop operation	Switching run/stop		The program running state (run/stop) can be changed with the operation buttons on the SmartAXIS.
Edit Program	Confirming/Clearing changed timer/counter preset values		Change timer/counter preset values or writes them to the user program in the ROM.
Configurations	Environment settings	Slave Number/ Message Scroll/Blink Menu Language/ LCD backlight ON time	Some of the function area settings (slave number, message scroll speed, scroll unit, blinking speed, and LCD backlight ON time) can be modified. The system menu language can also be changed.
	Calendar/Clock		Configures the calendar/clock of the SmartAXIS internal clock.
Monitors	Device Monitor		Displays/modifies the specified device values.
	Program Monitor		Displays the ladder program. The on/off state of bit devices can be changed. This is only enabled when ladder program is selected as the programming language.
	Status Monitor		Displays the system software version, operating status, scan time, and protection status.
	Error Monitor		Enables you to check errors that have occurred on the SmartAXIS.
Message display	Message display		Displays messages with pre-configured formats on the SmartAXIS LCD using the MSG instruction/FB.
Memory Cartridge	Uploading user program		The user program in the SmartAXIS can be transferred to the memory cartridge.
	Downloading user program		The user program on the memory cartridge can be transferred to the SmartAXIS.
SD memory card	Stop Access		Stops the access to the SD memory card in order to remove the SD memory card from the SmartAXIS.
	Format		Formats the SD memory card.

Initial Screen

The screen below is displayed when the SmartAXIS is purchased and first turned on.

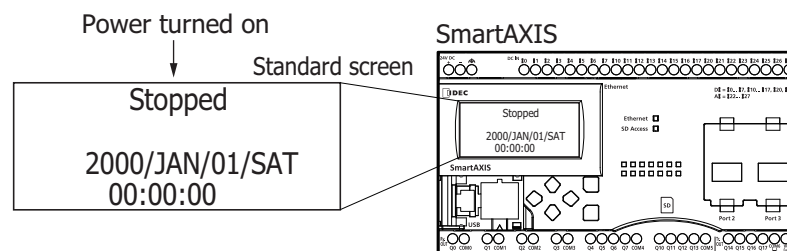

The default menu language is English. To switch the menu language to Japanese, see "Changing the Menu Language" on page 6-8.

About the Menu Screen

This section describes SmartAXIS menu screen.

When switching from the standard screen to the system menu screen, the menu items are displayed on the LCD.

Standard Screen

The standard screen is the screen that is displayed after the SmartAXIS is turned on. It shows the current date, time, and operating status (stopped/running).

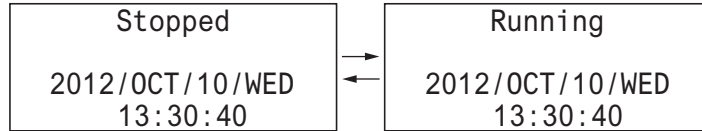

System Menu

You can execute operations, such as running and stopping the SmartAXIS, monitoring devices, and modifying the settings, on the system menu. The menu items displayed on the LCD differ according to the operating status (running/stopped) of the SmartAXIS.

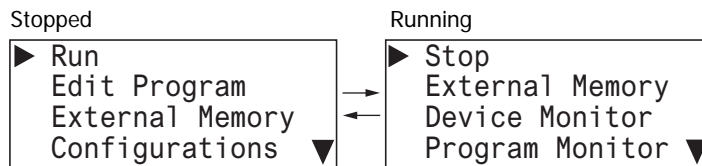

System Menu when SmartAXIS is stopped

The menu items displayed while the SmartAXIS is stopped are as follows.

- Run
- Edit Program
- External Memory
- Configurations
- Device Monitor
- Program Monitor
- Status Monitor
- Error Status

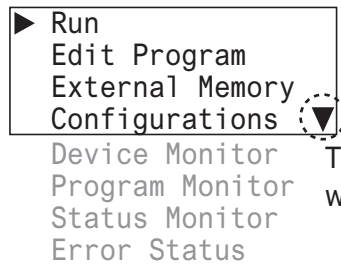

The ▼ symbol is displayed when menu items continue below.

System Menu while SmartAXIS is running

The menu items displayed while the SmartAXIS is running are as follows.

- Stop
- External Memory
- Device Monitor
- Program Monitor
- Status Monitor
- Error Status

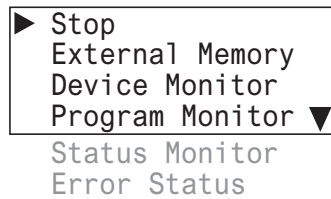

Message Screen

The SmartAXIS can display messages on the LCD using the MSG (message) instruction/FB. While the SmartAXIS is running, the message is displayed when the input conditions of MSG (message) instructions/FB are ON. Multiple message screens with different priorities can be switched and displayed with the ⬆ (up) and ⬇ (down) buttons.

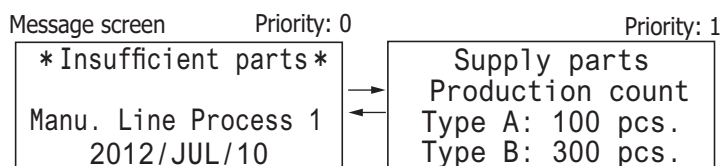

Basic Operations

This section describes how to use the SmartAXIS buttons.

The SmartAXIS Pro has the  (up),  (down),  (left),  (right),  (ESC), and  (OK) buttons, and these buttons are used to operate the screens displayed on the LCD.

Pushing the Switches

The operation of the buttons differs by how they are pressed. There are two ways to push the buttons, which are detailed below.

Press/Hold	Operation
Press (short press)	The switch is pressed for 0.1 seconds or more and less than three seconds and then released.
Press and hold (long press)	The switch is pressed for three seconds or more and then released.

(up), (down) buttons

Moves the cursor up and down to select menu items. These buttons are also used to modify numeric values and enter passwords.

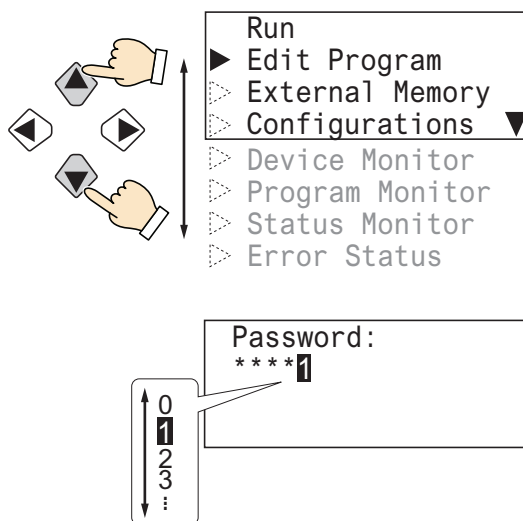

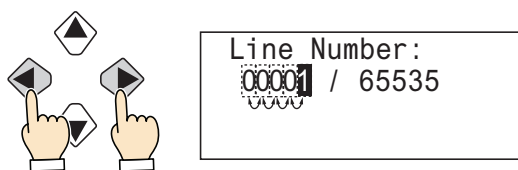

(left), (right) buttons

Moves the cursor left and right. These buttons are used to move the cursor while changing digits, entering password, or operating on the ladder display screen.



(ESC), (OK) buttons

Confirm menu items with the  (OK) button. Return to the previous screen with the  (ESC) button.

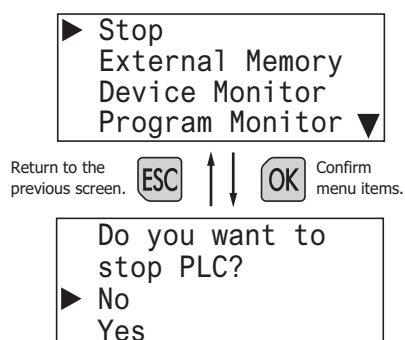

6: HMI FUNCTION

List of Button Operations on the System Menu Screen

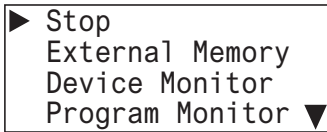

Switch	Press/Hold	Basic operation
▲	Press	Moves the cursor up one line. If the cursor is at the start of the item list, nothing happens.
	Press and hold	Repeats the press operation.
▼	Press	Moves the cursor down one item. If the cursor is at the end of the item list, nothing happens.
	Press and hold	Repeats the press operation.
◀	Press	Nothing happens.
	Press and hold	
▶	Press	
	Press and hold	
OK	Press	Executes the function selected with the cursor (depending on the function, displays additional menus).
	Press and hold	Nothing happens.
ESC	Press	Returns to the previous screen (the calling screen).
	Press and hold	While pressing the ESC (ESC) button, press the OK (OK) button to return to the top screen of the system menu.

List of Button Operations on the Ladder Monitor Screen

Ladder monitor screen

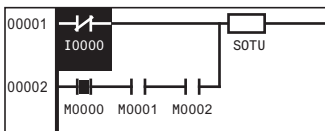

Switch	Press/Hold	Basic operation
▲	Press	Moves the cursor up one line. When the cursor is on the top line of the rung, nothing happens.
	Press and hold	Moves the cursor to the top line of one rung above. If the cursor is on the top rung, it moves the cursor to the top line of that rung.
▼	Press	Moves the cursor down one line. When the cursor is on the last line of the ladder, nothing happens.
	Press and hold	Moves the cursor to the top line of one rung below. If the cursor is on the bottom rung, it moves the cursor to the top line of that rung.
◀	Press	Moves the cursor once to the left. When the cursor is at the left edge of the line, nothing happens.
	Press and hold	Moves the cursor to the left edge. When the cursor is at the left edge of the line, nothing happens.
▶	Press	Moves the cursor once to the right. When the cursor is at the right edge of the line, nothing happens.
	Press and hold	Moves the cursor to the right edge. When the cursor is at the right edge of the line, nothing happens.
OK	Press	If the instruction selected by the cursor is a NO contact or a NC contact, toggles the on/off state. If the instruction selected by the cursor is not a NO contact or a NC contact, nothing happens.
	Press and hold	Displays the parameter details for the instruction selected with the cursor.
ESC	Press	Ends ladder monitor mode.
	Press and hold	Not valid.

List of Button Operations after Executing a System Menu Item

System menu

(Ladder monitor line setting)

Menu language selection

Line Number: 00001 / 65535	Menu Languages: Japanese
-------------------------------	-----------------------------

Switch	Press/Hold	Basic operation
◆	Press	Adds 1 to the number selected with the cursor. Shows the item above the item selected with the cursor. If the top of the item list is displayed, nothing happens.
	Press and hold	Repeats the press operation.
◆	Press	Subtracts 1 from the number selected with the cursor. Shows the item below the item selected with the cursor. If the bottom of the item list is displayed, nothing happens.
	Press and hold	Repeats the press operation.
◆	Press	Moves the cursor once to the left.
	Press and hold	Repeats the press operation.
◆	Press	Moves the cursor once to the right.
	Press and hold	Repeats the press operation.
OK	Press	Confirms the modification.
	Press and hold	Not valid.
ESC	Press	Discards the modification.
	Press and hold	While pressing the ESC (ESC) button, press the OK (OK) button to discard the modification and return to the top screen of the system menu.

Switching to the System Menu

This section describes how to switch to the system menu from the standard screen.

1. On the standard screen, while pressing the **ESC** (ESC) button, press the **OK** (OK) button.
In further descriptions, this is explained as "**ESC** (ESC) + **OK** (OK) buttons". (1) and (2) in the diagram indicate the order to push the switches.

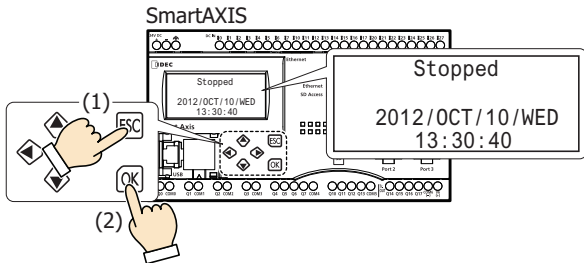

The system menu is displayed.

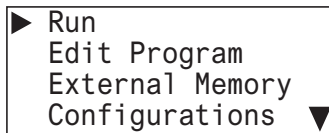

While the SmartAXIS is running, the top screen for the running system menu is displayed.



On the system menu screen, press the **ESC** (ESC) + **OK** (OK) buttons to return to the standard screen.

Switching run/stop

You can run and stop the SmartAXIS with the button operations.

Running the SmartAXIS

This section describes the steps to run the SmartAXIS.

1. On the standard screen, press the  (ESC) +  (OK) buttons.

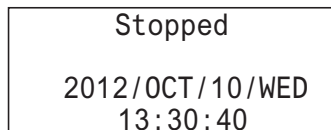

The system menu is displayed.

2. Select **Run** and press the  (OK) button.

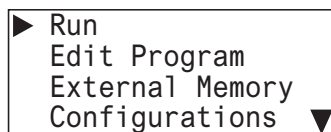

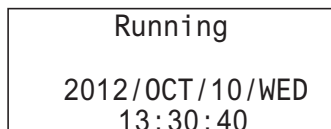

The SmartAXIS is set to run.



Caution When setting the SmartAXIS to run by using the buttons on the SmartAXIS module, fully ensure the safety before doing so.

Stopping the SmartAXIS

This section describes the steps to stop the SmartAXIS.

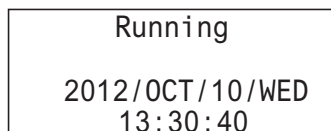

1. On the standard screen, press the  (ESC) +  (OK) buttons.

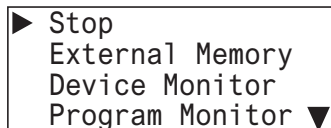

The system menu is displayed.

2. Select **Stop** and press the  (OK) button.



3. Select **Yes** with the  (down) button and press the  (OK) button.

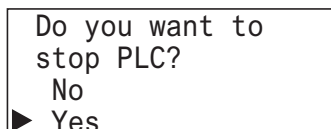

The SmartAXIS is set to stop.





SmartAXIS Environment Settings

When the SmartAXIS is stopped, you can configure the menu language, internal clock, slave number, and the scroll unit/speed and blinking speed for messages displayed with the message (MSG) instruction/FB. These cannot be configured while the SmartAXIS is running.

Changing the Menu Language

When the SmartAXIS is stopped, you can change the menu language between Japanese, English, and Chinese. This cannot be changed while the SmartAXIS is running. The menu language is set to English when the SmartAXIS is shipped from the factory, so this section describes how to switch the language to Japanese.

1. On the standard screen, press the  (ESC) +  (OK) buttons.

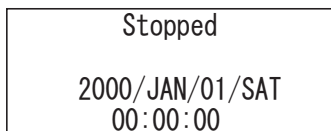

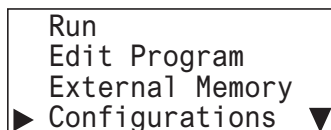

The system menu is displayed.

2. Select **Configurations** with the  (up) and  (down) buttons and press the  (OK) button.

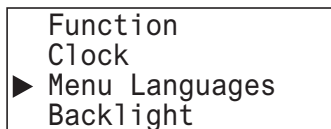

3. Select **Menu Languages** and press the  (OK) button.



4. Select **Japanese** with the  (down) button, and then press the  (OK) button to confirm.

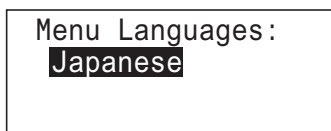

- **Selectable menu languages**

The menu languages that can be selected are as follows.
English/Japanese/Chinese

- **Retaining the menu language setting**

For system software version V2.20 and later, the menu language setting is retained in the ROM of the SmartAXIS. Even if the backup battery is dead, it is not required to change the menu language again.

Setting the Calendar/Clock

This section describes how to adjust the internal clock in the SmartAXIS. This cannot be adjusted while the SmartAXIS is running.

1. On the standard screen, press the **ESC** (ESC) + **OK** (OK) buttons.

```

Stopped
2012/OCT/10/WED
13:30:40
  
```

The system menu is displayed.

2. Select **Configurations** with the **▲** (up) and **▼** (down) buttons and press the **OK** (OK) button.

```

Run
Edit Program
External Memory
▶ Configurations ▼
  
```

3. Select **Clock** with the **▲** (up) and **▼** (down) buttons and press the **OK** (OK) button.

```

Function
▶ Clock
Menu Languages
Backlight
  
```

4. Select the year, month, or day to modify with the **◀** (left) and **▶** (right) buttons.

For example, modify **Day**.

```

2012/10/10
13: 30: 40
  
```

5. Modify **Day** with the **▲** (up) and **▼** (down) buttons.

```

2012/10/11
13: 30: 40
  
```

6. From **Day** position, press the **▶** (right) button to select the clock.

For example, modify **Minute**.

```

2012/10/11
13: 30: 40
  
```

7. Modify **Minute** with the **▲** (up) and **▼** (down) buttons.

```

2012/10/11
13: 35: 40
  
```

8. Press the **OK** (OK) button to confirm the modifications to the calendar/clock.

• Calendar/clock configuration range

The calendar/clock configuration range is as follows.

Year	Month	Day	Hour	Minute	Second
2000 to 2099	01 to 12	00 to 31	00 to 23	00 to 59	00 to 59

Notes:

- When the date is modified, the day of the week automatically changes. The day of the week is not displayed on the configuration screen.
- If an invalid date is set, an error message is displayed. When the error message is displayed, press the **ESC** (ESC) button or the **OK** (OK) button to return to the configuration screen, and then set a valid date.

6: HMI FUNCTION

Setting the LCD Backlight ON Time

When the SmartAXIS operation buttons are pressed, the backlight turns on.

After an operation button is pressed and the backlight turns on, the backlight automatically turns off if the operation buttons are not pressed. On the system menu, you can adjust the time from when the backlight turns on until it turns off.

1. On the standard screen, press the (ESC) + (OK) buttons.



The system menu is displayed.

2. Select **Configurations** with the (up) and (down) buttons and press the (OK) button.

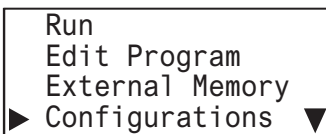

3. Select **Backlight** with the (up) and (down) buttons and press the (OK) button.

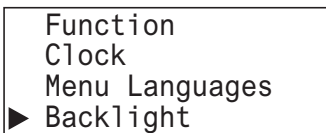

4. Move the cursor with the (left) and (right) buttons.

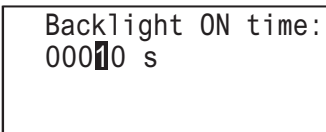

5. Select the value with the (up) and (down) buttons, and then press the (OK) button to set the backlight ON time.

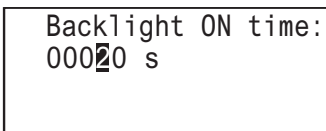

• Backlight ON time configuration range

The backlight ON time configuration range is as follows.



0 to 65,535 seconds

Notes:

- The default backlight ON time is 10 seconds. The default value can be modified in WindLDR Function Area Settings dialog box. For details, see "Backlight ON Time" on page 5-57.
- The backlight ON time can be changed by modifying the value of D8074.
- When the backlight ON time is set from the system menu, the value of D8074 is modified.
- The value of D8074 returns to the default value when the battery backup dies.
- If the backlight ON time is 0, the backlight is always on.

Configuring the Slave Number

When the SmartAXIS is stopped, you can configure the slave number used in maintenance communication or Modbus RTU communication. This cannot be configured while the SmartAXIS is running.

1. On the standard screen, press the  (ESC) +  (OK) buttons.

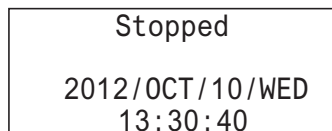



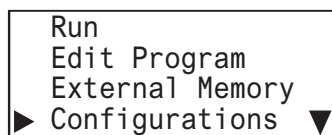

The system menu is displayed.

2. Select **Configurations** with the  (up) and  (down) buttons and press the  (OK) button.

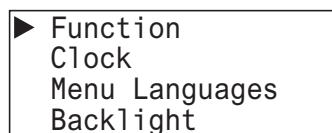

3. Select **Function** with the  (up) and  (down) buttons and press the  (OK) button.



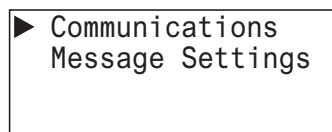

4. Select **Communications** with the  (up) and  (down) buttons and press the  (OK) button.

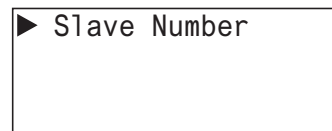

5. Select **Slave Number** with the  (up) and  (down) buttons and press the  (OK) button.





The port selection screen is displayed.

6. Select **Port 2** with the  (up) and  (down) buttons and press the  (OK) button.

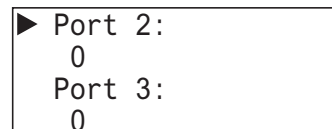
For example, change the slave number of the port 2 to **1**.



7. Specify **1** with the  (up) and  (down) buttons and press the  (OK) button.

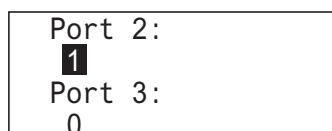



- **Selectable slave numbers**

The slave numbers that can be selected are as follows.

Port 2	Port 3
0 to 255	0 to 255

6: HMI FUNCTION

Notes:

- When the slave number is modified from the system menu, the value in the slave number type (constant/special data register) configured with WindLDR is modified. The slave number type cannot be changed from the system menu.
- If the slave number type configured with WindLDR is **Constant**, when the slave number is modified from the system menu and the  button is pressed, the modified slave number is reflected in the function area settings for the user program. If **Special Data Register**, the values of D8027 and D8028 are modified. (The modification is not reflected in the function area settings for the user program.)
- The values of D8027 and D8028 return to the default values when the battery backup dies.
- The slave number configuration range differs according to the communication mode (maintenance communication/Modbus RTU slave). If a value outside the configuration range is set, the following message is displayed. Press the  (ESC) button or the  button to return to the configuration screen, and then set the correct slave number again.

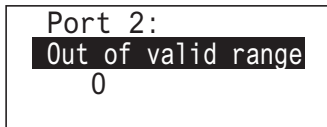



- For maintenance communication, see "Maintenance Communication via Expansion Communication Port" on page 9-3, and for Modbus RTU slaves, see "Modbus Communication via RS-232C/RS-485" on page 11-1.

Configuring the Network Settings

When the SmartAXIS (24/ 40/ 48-I/O type) is stopped, you can configure the network settings.

These cannot be configured while the SmartAXIS is running.

1. On the standard screen, press the  (ESC) +  (OK) buttons.

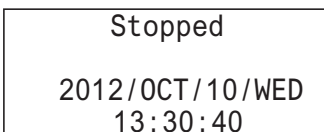



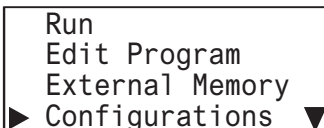

The system menu is displayed.

2. Select **Configurations** with the  (up) and  (down) buttons and press the  (OK) button.

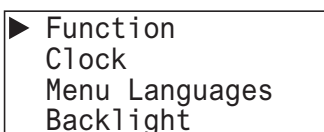

3. Select **Function** with the  (up) and  (down) buttons and press the  (OK) button.



4. Select **Communications** with the  (up) and  (down) buttons and press the  (OK) button.



5. Select **Network Settings** with the  (up) and  (down) buttons and press the  (OK) button.

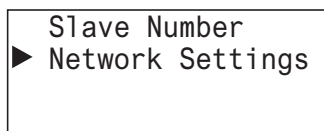

The network settings screen is displayed.



For example, change the IP address to 192. 168. 1. 6.

6. Select **IP Address** with the  (up) and  (down) buttons and press the  (OK) button.

```

Network Settings
DHCP: OFF
▶ IP Address:
  192.168. 1. 5



```

7. Specify **6** with the  (up) and  (down) buttons and press the  (OK) button.

```

IP Address:
192.168. 1. 6

```

8. Press  (ESC) button to set the network settings, and then select Yes with the  (down) button and press the  (OK) button.

```

Do you want to
configure network?
No
▶ Yes

```

The IP address is set to 192.168.1.6.

- **Network settings configuration range**

The network settings configuration range is as follows.

DHCP	IP Address	Subnet Mask	Default Gateway
ON/OFF	000.000.000.000 to 255.255.255.255	000.000.000.000 to 255.255.255.255	000.000.000.000 to 255.255.255.255

Notes:

- When DHCP is enabled, the network settings are automatically obtained and cannot be manually configured.
- You can monitor the current network settings from **Status Monitor**.

Modifying the Function Settings

Modifying the Scroll Speed

While the SmartAXIS is stopped, you can configure the scroll speed for messages displayed with the message (MSG) instruction/FB. This cannot be configured while the SmartAXIS is running.

1. In step 4 of **Configuring the Slave Number**, select **Message Settings** and press the  (OK) button.

```

Communications
▶ Message Settings

```

2. Select **Scroll Settings** with the  (up) and  (down) buttons and press the  (OK) button.

```

▶ Scroll Settings
  Blink Settings

```

3. Select **Scroll Speed** with the  (up) and  (down) buttons and press the  (OK) button.

```

▶ Scroll Speed:
  500 ms
  Scroll Unit:
  1-character

```

6: HMI FUNCTION

4. Modify the value with the  (up) and  (down) buttons and press the  (OK) button.

For example, change the value to 700 ms.

```
Scroll Speed:
 700 ms
Scroll Unit:
1-character
```

- **Selectable scroll speeds**

The scroll speeds that can be selected are as follows.

500/600/700/800/900/1000 ms

Configuring the Scroll Unit

When the SmartAXIS is stopped, you can configure the scroll unit for messages displayed with the message (MSG) instruction/FB. This cannot be configured while the SmartAXIS is running.

1. In step 3 of **Modifying the Scroll Speed**, select **Scroll Unit** and press the  (OK) button.

```
Scroll Speed:
 500 ms
▶ Scroll Unit:
1-character
```

2. Modify the scroll unit with the  (up) and  (down) buttons and press the  (OK) button.

```
Scroll Speed:
 500 ms
Scroll Unit:
1-dot
```

- **Selectable scroll units**

The scroll units that can be selected are as follows.

1 character/1 pixel

Configuring the Blinking Speed



When the SmartAXIS is stopped, you can configure the blinking speed for messages displayed with the message (MSG) instruction/FB. This cannot be configured while the SmartAXIS is running.

1. In step 2 of **Configuring the Scroll Speed**, select **Blink Settings** and press the  (OK) button.

```
Scroll Settings
▶ Blink Settings
```

2. Select **Blinking Speed** with the  (up) and  (down) buttons and press the  (OK) button.

```
▶ Blinking Speed:
 500 ms
```

3. Modify the value with the  (up) and  (down) buttons and press the  (OK) button. For example, change the value to 700 ms.

```
▶ Blinking Speed:
 700 ms
```

- **Selectable blinking speeds**

The blinking speeds that can be selected are as follows.

500/600/700/800/900/1000 ms

Monitoring the SmartAXIS

Monitoring Device Values

You can check device values on the SmartAXIS. When you switch the SmartAXIS to the device monitor mode from the standard screen, you can check device values, but you cannot modify them. To modify device values, run **Device Monitor** on the system menu. Device values can be monitored regardless of the SmartAXIS operating status (run/stop). This section describes the device monitor mode when the SmartAXIS is running.

1. If you press the ◀ (left) and ▶ (right) buttons on the standard screen, the SmartAXIS switches to the device monitor mode and the device values can be monitored. Continue to press the ◀ (left) and ▶ (right) buttons to change the device type.

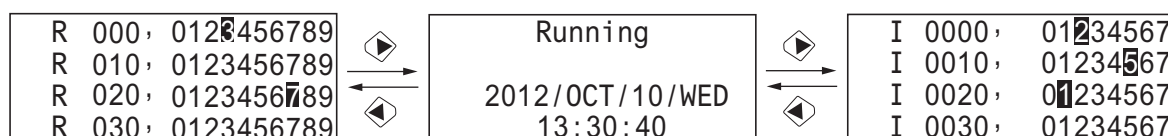

The device type changes in the order below.

I ↔ Q ↔ T ↔ TC ↔ TP ↔ C ↔ CC ↔ CP ↔ D (Data Register) ↔ D (Special Data Register) ↔ M (Internal Relay) ↔ M (Special Internal Relay) ↔ R

2. Press the ▲ (up) and ▼ (down) buttons.

The device numbers change.

I 0000, 01234567
I 0010, 01234567
I 0020, 01234567
I 0030, 012345

Shows the on/off state of the inputs (I).
Inverted inputs are on state.

▼

I 0010, 01234567
I 0020, 01234567
I 0030, 012345
I 0040, 01234567

Modifying Device Values

This section describes how to specify a device and modify that device value.

Modifying a Bit Device Value

This section describes an example of switching on M0012 while the SmartAXIS is running.

1. On the standard screen, press the **ESC** (ESC) + **OK** (OK) buttons.

Running
2012/OCT/10/WED
13:30:40

The system menu is displayed.



2. Select **Device Monitor** with the ▲ (up) and ▼ (down) buttons and press the **OK** (OK) button.
The SmartAXIS switches to the Device Monitor mode.

Stop
External Memory
▶ Device Monitor
Program Monitor ▼



3. Select device type: M (internal relay) with the ◀ (left) and ▶ (right) buttons and press and hold the **OK** (OK) button.
0 flashes to indicate the focus is on M0000.

▶ M 0000, 01234567
M 0010, 01234567
M 0020, 01234567
M 0030, 012345

6: HMI FUNCTION

- With the  (up) and  (down) buttons, select M0010.
0 flashes to indicate the focus is on M0010.

M 0000:	01234567
▶ M 0010:	01234567
M 0020:	01234567
M 0030:	012345



- Move the cursor to **2** with the  (right) button and press the  (OK) button.

M 0000:	01234567
▶ M 0010:	01234567
M 0020:	01234567
M 0030:	012345

M0012 turns on.

Modifying a Word Device Value

This section describes an example of changing D0002 to 500 while the SmartAXIS is running.



- On the standard screen, press the  (ESC) +  (OK) buttons.

Running
2012/OCT/10/WED
13:30:40



The system menu is displayed.

- Select **Device Monitor** with the  (up) and  (down) buttons and press the  (OK) button.
 The SmartAXIS switches to the Device Monitor mode.

Stop
External Memory
▶ Device Monitor
Program Monitor ▼

- Select device type: D (Data Register) with the  (left) and  (right) buttons and press and hold the  (OK) button.

▶ D 0000:	00100
D 0001:	00200
D 0002:	00300
D 0003:	00400

- Select D0002 with the  (up) and  (down) buttons and press the  (OK) button.

D 0000:	00100
D 0001:	00200
▶ D 0002:	00300
D 0003:	00400

- Move the digit with the  (right) button and modify the value with the  (up) and  (down) buttons.

Change Device Val.:
D 0000:00500
DEC (W)

- Press the  (OK) button to confirm.



D 0000:	00100
D 0001:	00200
▶ D 0002:	00500
D 0003:	00400

Writing/Clearing TP (Timer Preset Values) and CP (Counter Preset Values) in the User Program

Writing TP (Timer Preset Values) and CP (Counter Preset Values)

Even if you modify TP (Timer Preset Values) and CP (Counter Preset Values) with Device Monitor mode, those changes are not written to the user program in the ROM. To write the changed preset values to the ROM, you must stop the SmartAXIS and confirm the changes. When you modify TP (Timer Preset Values) and CP (Counter Preset Values) and attempt to leave Device Monitor mode, the message below is displayed.

Timer/counter preset values are changed.



1. Press the  (ESC) button or the  (OK) button to display the standard screen.

When the SmartAXIS is running When the SmartAXIS is stopped

Running T/C is changed 2012/OCT/10/WED 13:30:40	Stopped T/C is changed 2012/OCT/10/WED 13:30:40
--	--

When TP (timer preset values) and CP (counter preset values) differ from the device values in the ROM, **T/C is changed** is displayed on the standard screen.

When the SmartAXIS is running, put it to Stop mode. For the steps to stop the SmartAXIS, see "Switching run/stop" on page 6-7.

2. On the standard screen, press the  (ESC) +  (OK) buttons.

Stopped
 T/C is changed
 2012/OCT/10/WED
 13:30:40



The system menu is displayed.

3. Select **Edit Program** with the  (up) and  (down) buttons and press the  (OK) button.

Run
 ▶ Edit Program
 External Memory
 Configurations ▼

4. Select **T/C Preset Values** and press the  (OK) button.



▶ T/C Preset Values

5. Select **Confirm** with the  (up) and  (down) buttons and press the  (OK) button.

T/C Change Status:
 T/C is changed
 Clear
 ▶ Confirm

The changed preset values are written to the user program in the ROM.

Clearing TP (Timer Preset Values) and CP (Counter Preset Values)

1. In step 5 of Writing TP (Timer Preset Values) and CP (Counter Preset Values), select **Clear** with the  (up) and  (down) buttons, and press the  (OK) button.

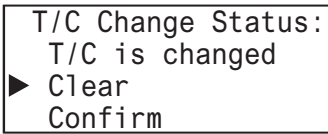



The changes made to the timer and counter preset values are deleted. The preset values of the user program in the ROM remain as they are before those values are modified. The device values return to the values before they are modified.

Note: Using WindLDR, you can also write the preset values to the user program in the ROM. Select **Online > Monitor > Start Monitor**. Select **Online > PLC > Status** to display the PLC Status dialog box, and click the **Confirm** button under **Timer/counter preset value modification** state. Once preset values are confirmed, they cannot be restored to their previous values, even if they are cleared.

Monitoring the User Program

You can monitor the ladder program while the SmartAXIS is running or stopped when ladder program is selected as the programming language.

The on/off state of bit devices can also be modified.

1. On the standard screen, press the  (ESC) +  (OK) buttons.

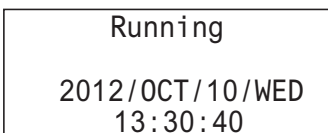

When the SmartAXIS is running

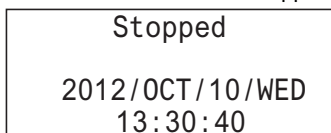

When the SmartAXIS is stopped



The system menu is displayed.

2. Select **Program Monitor** with the  (up) and  (down) buttons and press the  (OK) button.

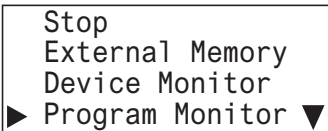

When the SmartAXIS is running



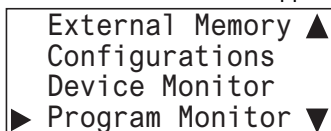



When the SmartAXIS is stopped

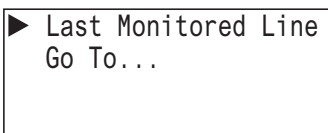

The SmartAXIS switches to the Program Monitor mode.

3. Select **Last Monitored Line** with the  (up) and  (down) buttons and press the  (OK) button.



4. The cursor can be moved with the  (up),  (down),  (left), and  (right) buttons.

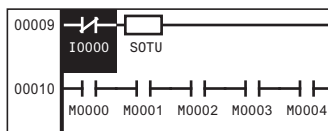



For details on the ladder program monitor, see Chapter 2 "Ladder Program Monitoring on the SmartAXIS" in the SmartAXIS Ladder Programming Manual.

Note: When FBD program is selected as the programming language, **Program Monitor** and the System Menu items under it are not displayed on the screen in step 2.

Monitoring the SmartAXIS Status

You can check the SmartAXIS system software version, operating status, scan time, and protection status.

1. On the standard screen, press the  (ESC) +  (OK) buttons.

When the SmartAXIS is running

```

Running
2012/OCT/10/WED
13:30:40
  
```

When the SmartAXIS is stopped

```

Stopped
2012/OCT/10/WED
13:30:40
  
```

The system menu is displayed.

2. Select **Status Monitor** with the  (up) and  (down) buttons and press the  (OK) button.

When the SmartAXIS is running

```

External Memory ▲
Device Monitor
Program Monitor
▶ Status Monitor ▼
  
```

When the SmartAXIS is stopped

```

Configurations ▲
Device Monitor
Program Monitor
▶ Status Monitor ▼
  
```

3. The system version is displayed. Press the  (down) button.

When the SmartAXIS is running

```

System Version:
1.00
Run/Stop Status:
Running ▼
  
```

When the SmartAXIS is stopped

```

System Version:
1.00
Run/Stop Status:
Stopped ▼
  
```

4. The scan time is displayed. Press the  (down) button.

```

Scan Time: ▲
Current:    2 ms
Maximum:   4 ms
Minimum:   2 ms ▼
  
```

5. The upload protection status is displayed. Press the  (down) button.

```

Protection Status: ▲
Read Program:
Prohibited ▼
  
```

6. The download protection status is displayed.

```

Protection Status: ▲
Write Program:
Password
  
```

Checking/Clearing Error Information

When an error occurs while the SmartAXIS is running, an error message is displayed on the LCD. This section describes the steps for checking the details and clearing the error.

1. When an error occurs, the following message is displayed.

When an error occurs while SmartAXIS is running and the SmartAXIS stops

```
Error!  
PLC is stopped.  
Press OK button for  
more details.
```

When an error occurs while SmartAXIS is running and the SmartAXIS continues running

```
Error!  
PLC is running.  
Press OK button for  
more details.
```



2. Press and hold the  (OK) button. The error code is displayed.

```
▶General Error: 3  
Execution Error:0  
Clear Error
```



Error details can also be checked from **Error Status** on the system menu.

3. Select the error type with the  (up) and  (down) buttons and press the  (OK) button. Only errors that have occurred are displayed.

```
General Error: 3  
Power failure  
Watchdog Timer
```

4. Press the  (ESC) button.
5. Select **Clear Error** with the  (down) button and press the  (OK) button.

```
General Error: 3  
Execution Error:0  
▶Clear Error
```

6. Select **Yes** with the  (down) button and press the  (OK) button.

```
Do you want to  
clear error code?  
No  
▶Yes
```

General errors and user program execution error are cleared.

Note: For details on error information, see "Troubleshooting" on page 14-1.

Checking Error Information from the System Menu

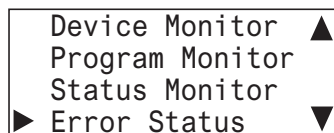

You can check error information from the system menu.

1. On the standard screen, press the  (ESC) +  (OK) buttons.
The system menu is displayed.
2. Select **Error Status** with the  (up) and  (down) buttons and press the  (OK) button.

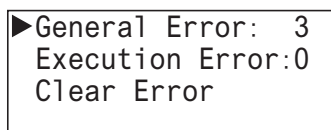

3. The error code is displayed.



4. Select the error type with the  (up) and  (down) buttons and press the  (OK) button.
Only errors that have occurred are displayed.

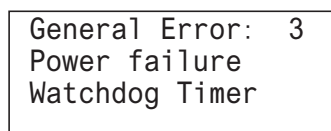

Uploading/Downloading the User Program

While the SmartAXIS is stopped, you can upload the user program in the SmartAXIS to the memory cartridge. You can also download the user program in the memory cartridge to the SmartAXIS.

Uploading the User Program (SmartAXIS to Memory Cartridge)

You can upload the user program in the SmartAXIS to the memory cartridge. This function cannot be used while the SmartAXIS is running.

1. On the standard screen, press the (ESC) + (OK) buttons.



The system menu is displayed.

2. Select **External Memory** with the (up) and (down) buttons and press the (OK) button.

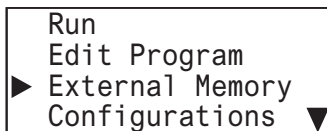

3. Select **Memory Cartridge** with the (up) and (down) buttons and press the (OK) button.

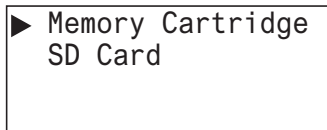

4. Select **PLC -> Cartridge** with the (up) and (down) buttons and press the (OK) button.

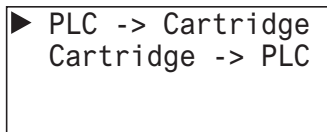

5. If the password is configured, you are prompted to enter the password.
Enter the password with the (up), (down), (left), and (right) buttons and press the (OK) button.

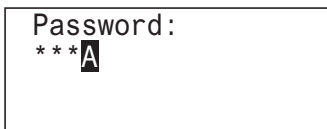

Entering the password is required for the following cases:

- The user program in the SmartAXIS is password-protected against the user program upload.
- The user program in the memory cartridge is password-protected against the user program download.

The confirmation screen is displayed.

6. Select **Yes** with the (down) button and press the (OK) button.

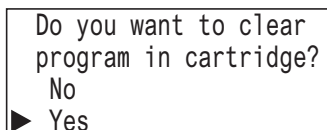

7. The screen below is displayed while the user program is uploaded. When the upload is finished, the screen in step 4 is displayed.



Notes:

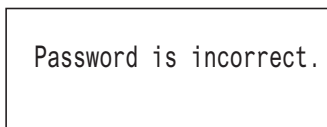

- In either of the situations below, the password must be entered.
- The user program on the SmartAXIS has been password protected for program uploads.
- The user program on the memory cartridge has been password protected for program downloads.
- If an invalid password is entered in step 5, the screen below is displayed.



Press the (ESC) button or the (OK) button to return to step 4, and then enter the correct password in step 5.

Downloading the User Program (Memory Cartridge to SmartAXIS)

You can download the user program in the memory cartridge to the SmartAXIS. This function cannot be used while the SmartAXIS is running.

1. On the standard screen, press the  (ESC) +  (OK) buttons.

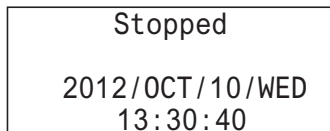

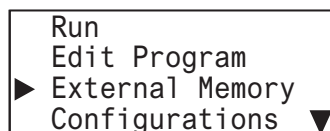

The system menu is displayed.

2. Select **External Memory** with the  (up) and  (down) buttons and press the  (OK) button.



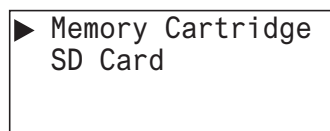



3. Select **Memory Cartridge** with the  (up) and  (down) buttons and press the  (OK) button.

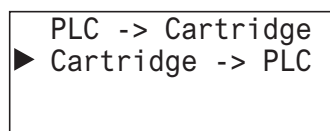

4. Select **Cartridge -> PLC** with the  (up) and  (down) buttons and press the  (OK) button.



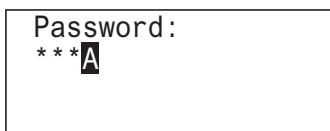

5. If the password is configured, you are prompted to enter the password.
Enter the password with the  (up),  (down),  (left), and  (right) buttons and press the  (OK) button.



Entering the password is required for the following cases:

- The user program in the SmartAXIS is password-protected against the user program download.
- The user program in the memory cartridge is password-protected against the user program upload.

The confirmation screen is displayed.

6. Select **Yes** with the  (down) button and press the  (OK) button.

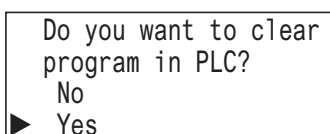

7. The screen below is displayed while the user program is downloaded. When the download is finished, the screen in step 4 is displayed.

**Notes:**

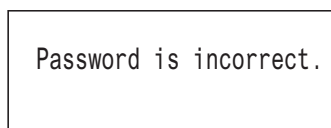

- In either of the situations below, the password must be entered.
 - The user program on the SmartAXIS has been password protected for program uploads.
 - The user program on the memory cartridge has been password protected for program downloads.
- If an invalid password is entered in step 5, the screen below is displayed.



Press the  (ESC) button or the  (OK) button to return to step 4, and then enter the correct password in step 5.

Displaying Arbitrary Messages

The SmartAXIS can display messages on the LCD by executing the MSG (message) instruction/FB.

When the display conditions for multiple MSG instructions/FB are satisfied, the messages are displayed according to the priorities set for the MSG instructions/FB. The message with the highest priority is displayed, out of all the MSG instructions/FB with the inputs on, by pressing the  (up) button on the standard screen. By further pressing the  (up) button, the message with the next highest priority is displayed.

Switching between Multiple Message Screens

1. On the standard screen, press the  (up) button.

Running

2012/OCT/10/WED

13:30:40

The message with the highest priority is displayed out of all the MSG instructions/FB with the inputs on.

Today's production count

Type A: 10000 pcs.

Type B: 30000 pcs.

2. Press the  (up) button.
The message with the next highest priority is displayed.

Insufficient parts

Manu. Line Process 1

2012/07/10

3. Press the  (down) button.

Today's production count

Type A: 10000 pcs.

Type B: 30000 pcs.

4. Press the  (ESC) button to return to the standard screen.

For details on the MSG instruction, see Chapter 13 "Display Instructions" in the "SmartAXIS Ladder Programming Manual".



For details on the MSG FB, see Chapter 14 "The interface FB" in the "SmartAXIS FBD Programming Manual".

Maintaining the SD Memory Card

Access to the memory card inserted into the SmartAXIS can be stopped while the SmartAXIS is running or stopped. The memory card inserted into the SmartAXIS can also be formatted while the SmartAXIS is stopped. The memory card cannot be formatted while the SmartAXIS is running.

Stopping Access to the SD Memory Card

This section describes how to stop the access to the SD memory card with the button operations on the SmartAXIS.

1. On the standard screen, press the  (ESC) +  (OK) buttons.

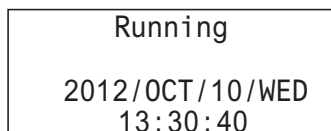

The system menu is displayed.

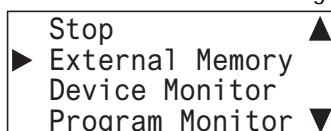

2. Select **External Memory** with the  (up) and  (down) buttons and press the  (OK) button.

When the SmartAXIS is running

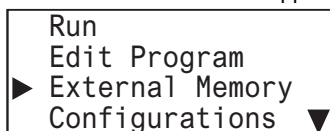

When the SmartAXIS is stopped



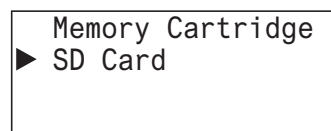

3. Select **SD Card** with the  (up) and  (down) buttons and press the  (OK) button.

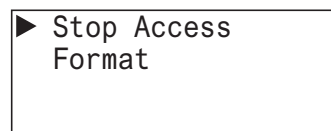

4. Select **Stop Access** with the  (up) and  (down) buttons and press the  (OK) button.



5. Select **Yes** with the  (down) button and press the  (OK) button.

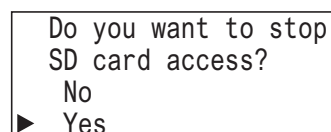

6. While the access to the SD memory card is being stopped, the screen below is displayed. When stopping the access is finished, the screen in step 4 is displayed.





Notes:

- Set the write-protect switch on the SD memory card to insert into the SmartAXIS module to the off position.
- Insert and remove the SD memory card in the direction indicated on the SmartAXIS.
- Do not remove the SD memory card while the access to it is being stopped. There is a risk of damage to the SD memory card and the data stored on it. Check that the SD memory card access LED is off before removing the SD memory card from the SmartAXIS.

6: HMI FUNCTION



Format SD memory card with the SmartAXIS

This section describes how to format the SD memory card in the SmartAXIS. In order to save the log data, format the SD memory card in the SmartAXIS.



1. On the standard screen, press the  (ESC) +  (OK) buttons.





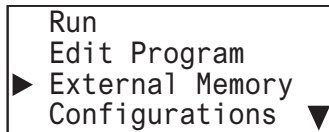

The system menu is displayed.

2. Select **External Memory** with the  (up) and  (down) buttons and press the  (OK) button.

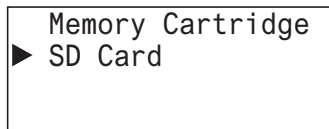



3. Select **SD Card** with the  (up) and  (down) buttons and press the  (OK) button.

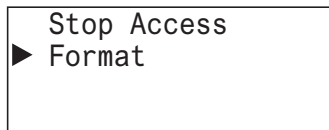

4. Select **Format** with the  (up) and  (down) buttons and press the  (OK) button.



5. Select **Yes** with the  (down) button and press the  (OK) button.

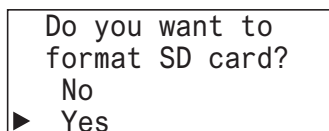

6. While the SD memory card is being formatted, the screen below is displayed. When the format is finished, the screen in step 4 is displayed.





Entering a Password

This section describes how to unlock the password protection configured in the user program for uploading and downloading by WindLDR and the memory cartridge.

1. When the password screen is displayed, the cursor is on the first character.



Password:
0

2. With the  (up) and  (down) buttons, select an alphanumeric character. Following 0 through 9, you can select A through Z and a through z.

Password:
1

3. Move the cursor to the second character with the  (right) button.

Password:
*0

4. With the  (up) and  (down) buttons, select an alphanumeric character.
5. Enter the password using the same steps and press the  (OK) button.

Password:
* * * A

When the correct password is entered, the menu for the next step is displayed.

Notes:

- The characters that can be entered on the password screen are as follows. However, the space cannot be used as a password.

0	1	2	3	4	5	6	7	8	9
A	B	C	D	E	F	G	H	I	J
K	L	M	N	O	P	Q	R	S	T
U	V	W	X	Y	Z	a	b	c	d
e	f	g	h	i	j	k	l	m	n
o	p	q	r	s	t	u	v	w	x
y	z								

- If you enter a wrong character, it can be deleted by selecting the space.

System Menu Hierarchy Diagram

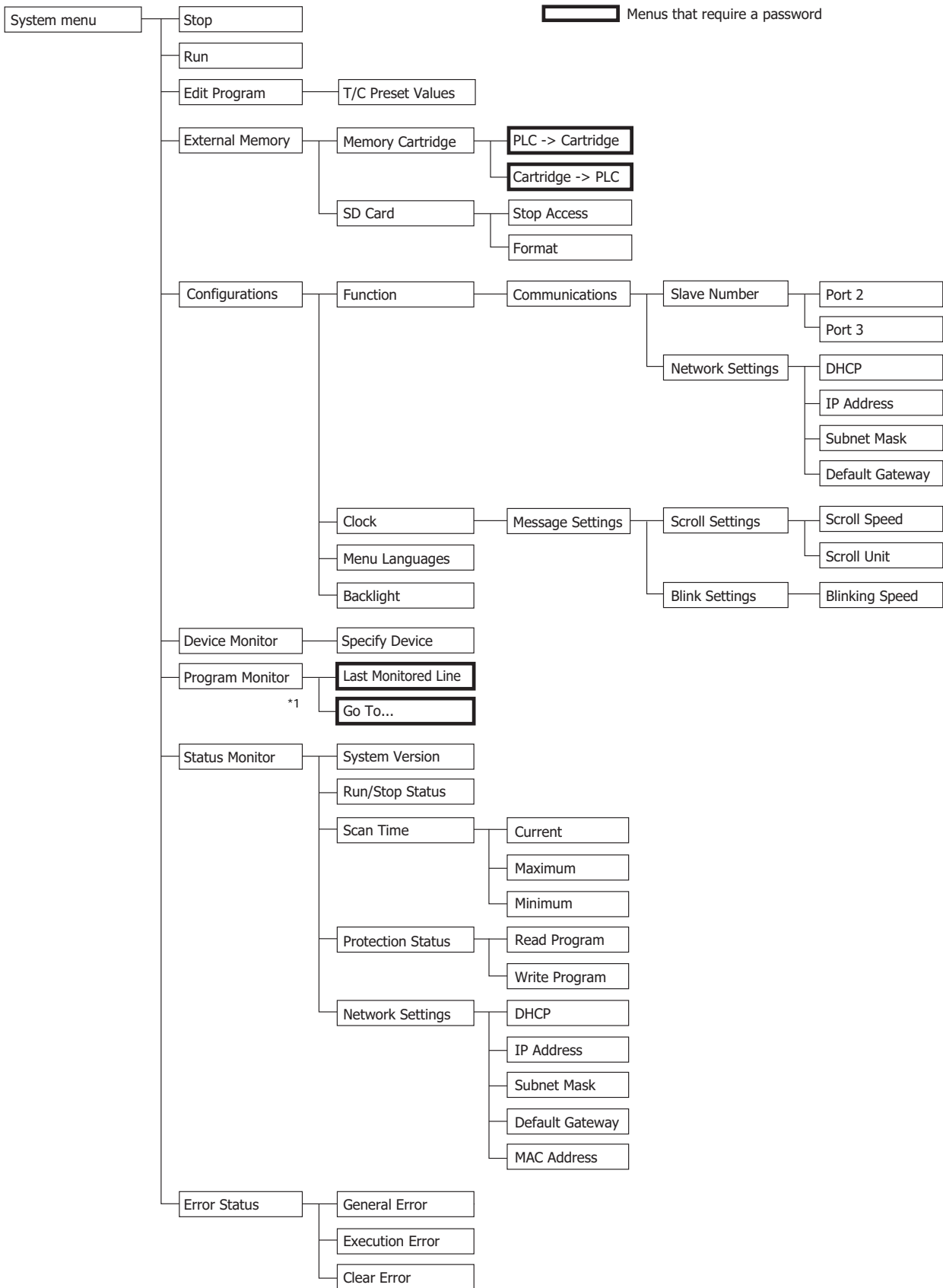

*1 When FBD program is selected as the programming language, **Program Monitor** and the System Menu items under it are not displayed.

7: DEVICE ADDRESSES

Introduction

This chapter describes device addresses available for the SmartAXIS. Special internal relays and special data registers are also described.

The SmartAXIS is programmed using devices such as inputs, outputs, remote inputs, remote outputs, internal relays, timers, counters, shift registers, and data registers.

Inputs (I) are relays to receive input signals through the input terminals.

Remote inputs (I) are relays to receive input signals from external devices connected to the remote I/O slaves.

Outputs (Q) are relays to send the processed results of the user program to the output terminals.

Remote outputs (O) are relays to send output signals to external devices connected to the remote I/O slaves.

Internal relays (M) are relays used in the CPU and cannot be outputted to the output terminals.

Special internal relays (M) are internal relays dedicated to specific functions.

Timers (T) are relays used in the user program, available in 1-sec, 100-ms, 10-ms, and 1-ms timers.

Counters (C) are relays used in the user program, available in adding counters and reversible counters.

Shift registers (R) are registers to shift the data bits according to pulse inputs.

Data registers (D) are registers used to store numerical data.

Special data registers (D) are dedicated to special functions.

Device Addresses

Available I/O numbers depend on the type of the SmartAXIS.

Device	FT1A-12		FT1A-24		FT1A-40		FT1A-48		FT1A Touch	
	Device Address	Points	Device Address	Points	Device Address	Points	Device Address	Points	Device Address	Points
Input (I)*	I0 - I7	8	I0 - I7 I10 - I17	16	I0 - I7 I10 - I17 I20 - I27	24	I0 - I7 I10 - I17 I20 - I27 I30 - I35	30	I0 - I7	8
Remote Input (I)*	—	—	I40 - I75 I80 - I115 I120 - I155	90	I40 - I75 I80 - I115 I120 - I155	90	I40 - I75 I80 - I115 I120 - I155	90	I40 - I75 I80 - I115 I120 - I155	90
Output (Q)*	Q0 - Q3	4	Q0 - Q7	8	Q0 - Q7 Q10 - Q17	16	Q0 - Q7 Q10 - Q17 Q20, Q21	18	Q0 - Q3	4
Remote Output (Q)*	—	—	Q40 - Q61 Q80 - Q101 Q120 - Q141	54	Q40 - Q61 Q80 - Q101 Q120 - Q141	54	Q40 - Q61 Q80 - Q101 Q120 - Q141	54	Q40 - Q61 Q80 - Q101 Q120 - Q141	54
Internal Relay (M)*	M0 - M317	256	M0 - M1277	1024	M0 - M1277	1024	M0 - M1277	1024	M0 - M1277	1024
Special Internal Relay (M)*	M8000 - M8177	144	M8000 - M8177	144	M8000 - M8177	144	M8000 - M8177	144	M8000 - M8177	144
Shift Register (R)	R0 - R127	128	R0 - R127	128	R0 - R127	128	R0 - R127	128	R0 - R127	128
Timer (T)	T0 - T99	100	T0 - T199	200	T0 - T199	200	T0 - T199	200	T0 - T199	200
Counter (C)	C0 - C99	100	C0 - C199	200	C0 - C199	200	C0 - C199	200	C0 - C199	200
Data Register (D)*³	D0 - D399	400	D0 - D1999* ²	2000	D0 - D1999* ²	2000	D0 - D1999* ²	2000	D0 - D1999	2000
Special Data Register (D)	D8000 - D8199	200	D8000 - D8199	200	D8000 - D8199	200	D8000 - D8199	200	D8000 - D8199	200

Notes:

*1 The least significant digit of input, output, internal relay, and special internal relay device address is an octal number (0 through 7). Upper digits are decimal numbers.

*2 Out of data registers D0 through D1999, D1000 through D1999 cannot be designated as "keep" types. Retained in STOP→RUN, but zeroed out when the power is turned on.

*3 When you use data register ROM backup, you can initialize the data registers with the values backed up in ROM. For details, see Chapter 5 "Special Functions" – "Data Register ROM Backup" on page 5-9.

7: DEVICE ADDRESSES

Special Internal Relays

Special internal relays M8000 through M8177 are used for controlling the CPU operation and communication, and for indicating the CPU statuses. All special internal relays cannot be used as destinations of advanced instructions.

Internal relays M300 through M335 are used to read input device statuses of the IOREF (I/O refresh) instruction.

Note: Do not change the status of reserved special internal relays, otherwise the SmartAXIS may not operate correctly.

Special Internal Relay Device Addresses

Device Address	Description	CPU Stopped	Power OFF	Read/Write	Ladder	FBD	
M8000	Start Control	Maintained	Maintained	Write	X	X	
M8001	1-sec Clock Reset	Cleared	Cleared	Write	X	X	
M8002	All Outputs OFF	Cleared	Cleared	Write	X	X	
M8003	Carry (Cy) or Borrow (Bw)	Cleared	Cleared	Read	X	—	
M8004	User Program Execution Error	Cleared	Cleared	Read	X	X	
M8005	Remote I/O Slave 1 Communication Error	Operating	Cleared	Read	X	X	
M8006	Remote I/O Slave 2 Communication Error	Operating	Cleared	Read	X	X	
M8007	Remote I/O Slave 3 Communication Error	Operating	Cleared	Read	X	X	
M8010	In daylight saving time period (system version 1.10 or later)	Operating	Cleared	Read	X	X	
M8011- M8012	— Reserved —	—	—	—	—	—	
M8013	Calendar/Clock Data Write/Adjust Error Flag	Operating	Cleared	Read	X	X	
M8014	Calendar/Clock Data Read Error Flag	Operating	Cleared	Read	X	X	
M8015	— Reserved —	—	—	—	—	—	
M8016	Calendar Data Write Flag	Operating	Cleared	Write	X	X	
M8017	Clock Data Write Flag	Operating	Cleared	Write	X	X	
M8020	Calendar/Clock Data Write Flag	Operating	Cleared	Write	X	X	
M8021	Clock Data Adjust Flag	Operating	Cleared	Write	X	X	
M8022	User Communication Receive Instruction Cancel Flag (Port 2)	Cleared	Cleared	Write	X	—	
M8023	User Communication Receive Instruction Cancel Flag (Port 3)	Cleared	Cleared	Write	X	—	
M8024	BMOV/WSFT Executing Flag	Maintained	Maintained	Read	X	—	
M8025	Maintain Outputs While CPU Stopped	Maintained	Cleared	Read/Write	X	X	
M8026	SD Memory Card Status	Maintained	Cleared	Read	X	X	
M8027	SD Memory Card Writing Flag	Maintained	Cleared	Read	X	X	
M8030	High-speed Counter (Group 1/10)	Comparison Output Reset	Cleared	Cleared	Read/Write	X	X*
M8031		Gate Input	Maintained	Cleared	Read/Write	X	X*
M8032		Reset Input	Maintained	Cleared	Read/Write	X	X*
M8033		Reset Status	Maintained	Cleared	Read	X	X
M8034		Comparison ON Status	Maintained	Cleared	Read	X	X
M8035		Overflow	Maintained	Cleared	Read	X	X
M8036		Underflow	Maintained	Cleared	Read	X	X
M8037		Count Direction	Maintained	Cleared	Read	X	X
M8040	High-speed Counter (Group 2/12)	Comparison Output Reset	Cleared	Cleared	Read/Write	X	X*
M8041		Gate Input	Maintained	Cleared	Read/Write	X	X*
M8042		Reset Input	Maintained	Cleared	Read/Write	X	X*
M8043		Comparison ON Status	Maintained	Cleared	Read	X	X
M8044		Overflow	Maintained	Cleared	Read	X	X
M8045	High-speed Counter (Group 3/13)	Comparison Output Reset	Cleared	Cleared	Read/Write	X	X*
M8046		Gate Input	Maintained	Cleared	Read/Write	X	X*
M8047		Reset Input	Maintained	Cleared	Read/Write	X	X*
M8050		Reset Status	Maintained	Cleared	Read	X	X
M8051		Comparison ON Status	Maintained	Cleared	Read	X	X
M8052		Overflow	Maintained	Cleared	Read	X	X
M8053		Underflow	Maintained	Cleared	Read	X	X
M8054		Count Direction	Maintained	Cleared	Read	X	X

Device Address	Description		CPU Stopped	Power OFF	Read/Write	Ladder	FBD
M8055	High-speed Counter (Group 4/15)	Comparison Output Reset	Cleared	Cleared	Read/Write	X	X [*]
M8056		Gate Input	Maintained	Cleared	Read/Write	X	X [*]
M8057		Reset Input	Maintained	Cleared	Read/Write	X	X [*]
M8060		Comparison ON Status	Maintained	Cleared	Read	X	X
M8061		Overflow	Maintained	Cleared	Read	X	X
M8062- M8067	— Reserved —		—	—	—	—	—
M8070	Interrupt Input I0 Status	(ON: Allowed, OFF: Prohibited)	Cleared	Cleared	Read	X	—
M8071	Interrupt Input I2 Status		Cleared	Cleared	Read	X	—
M8072	Interrupt Input I3 Status		Cleared	Cleared	Read	X	—
M8073	Interrupt Input I5 Status		Cleared	Cleared	Read	X	—
M8074	Interrupt Input I6 Status		Cleared	Cleared	Read	X	—
M8075	Interrupt Input I7 Status		Cleared	Cleared	Read	X	—
M8076	SD Memory Card Access Stop Flag		Operating	Cleared	Write	X	X
M8077	— Reserved —		—	—	—	—	—
M8080	Interrupt Input I0 Edge	(ON: Rising, OFF: Falling)	Cleared	Cleared	Read	X	—
M8081	Interrupt Input I2 Edge		Cleared	Cleared	Read	X	—
M8082	Interrupt Input I3 Edge		Cleared	Cleared	Read	X	—
M8083	Interrupt Input I5 Edge		Cleared	Cleared	Read	X	—
M8084	Interrupt Input I6 Edge		Cleared	Cleared	Read	X	—
M8085	Interrupt Input I7 Edge		Cleared	Cleared	Read	X	—
M8086 M8087	— Reserved —		—	—	—	—	—
M8090	Catch Input ON/OFF Status	Group 1/I0	Maintained	Cleared	Read	X	X
M8091		Group 2/I2	Maintained	Cleared	Read	X	X
M8092		Group 3/I3	Maintained	Cleared	Read	X	X
M8093		Group 4/I5	Maintained	Cleared	Read	X	X
M8094		Group 5/I6	Maintained	Cleared	Read	X	X
M8095		Group 6/I7	Maintained	Cleared	Read	X	X
M8096 M8097	— Reserved —		—	—	—	—	—
M8100	User Communication	Connection 1	Cleared	Cleared	Write	X	—
M8101	Receive Instruction Cancel Flag	Connection 2	Cleared	Cleared	Write	X	—
M8102		Connection 3	Cleared	Cleared	Write	X	—
M8103- M8107	— Reserved —		—	—	—	—	—
M8110	Connection Status	Connection 1 (ON: Connected, OFF: Not Connected)	Operating	Cleared	Read	X	X
M8111		Connection 2 (ON: Connected, OFF: Not Connected)	Operating	Cleared	Read	X	X
M8112		Connection 3 (ON: Connected, OFF: Not Connected)	Operating	Cleared	Read	X	X
M8113- M8117	— Reserved —		—	—	—	—	—
M8120	Initialize Pulse		Cleared	Cleared	Read	X	X
M8121	1-sec Clock		Operating	Cleared	Read	X	X
M8122	100-ms Clock		Operating	Cleared	Read	X	X
M8123	10-ms Clock		Operating	Cleared	Read	X	X
M8124	Timer/Counter Preset Value Changed		Maintained	Cleared	Read	X	X
M8125	In-operation Output		Cleared	Cleared	Read	X	X
M8126 M8127	— Reserved —		—	—	—	—	—

7: DEVICE ADDRESSES

Device Address	Description	CPU Stopped	Power OFF	Read/Write	Ladder	FBD	
M8130	Disconnect User Communication Connection	Connection 1	Maintained	Cleared	Read/Write	X	—
M8131		Connection 2	Maintained	Cleared	Read/Write	X	—
M8132		Connection 3	Maintained	Cleared	Read/Write	X	—
M8133- M8143	— Reserved —		—	—	—	—	—
M8144	Timer Interrupt Status (ON: Allowed, OFF: Prohibited)		Cleared	Cleared	Read	X	—
M8145- M8147	— Reserved —		—	—	—	—	—
M8150	Comparison Result 1		Maintained	Cleared	Read	X	—
M8151	Comparison Result 2		Maintained	Cleared	Read	X	—
M8152	Comparison Result 3		Maintained	Cleared	Read	X	—
M8153	— Reserved —		—	—	—	—	—
M8154	Data Register ROM Backup	Write	Operating	Cleared	Read/Write	X	X
M8155		Read	Operating	Cleared	Read/Write	X	X
M8156- M8157	— Reserved —		—	—	—	—	—
M8160	Key Input Status	ESC Key + Up Key	Cleared	Cleared	Read	X	X
M8161		ESC Key + Down Key	Cleared	Cleared	Read	X	X
M8162		ESC Key + Left Key	Cleared	Cleared	Read	X	X
M8163		ESC Key +Right Key	Cleared	Cleared	Read	X	X
M8164 M8165	— Reserved —		—	—	—	—	—
M8166	High-speed Counter (Group5/16)	Comparison Output Reset	Cleared	Cleared	Read/Write	X	X*
M8167		Gate Input	Maintained	Cleared	Read/Write	X	X*
M8170		Reset Input	Maintained	Cleared	Read/Write	X	X*
M8171		Comparison ON Status	Maintained	Cleared	Read	X	X
M8172		Overflow	Maintained	Cleared	Read	X	X
M8173	High-speed Counter (Group 6/17)	Comparison Output Reset	Cleared	Cleared	Read/Write	X	X*
M8174		Gate Input	Maintained	Cleared	Read/Write	X	X*
M8175		Reset Input	Maintained	Cleared	Read/Write	X	X*
M8176		Comparison ON Status	Maintained	Cleared	Read	X	X
M8177		Overflow	Maintained	Cleared	Read	X	X

*1 Read only when FBD program is selected as the programming method.

M8000 Start Control

M8000 is used to control the operation of the CPU. The CPU stops operation when M8000 is turned off while the CPU is running. M8000 can be turned on or off using the WindLDR Online menu. When a stop or reset input is designated, M8000 must remain on to control the CPU operation using the stop or reset input.

M8000 maintains its status when the CPU is powered down. When the data to be maintained during power failure is broken after the CPU has been off for a period longer than the battery backup duration, the CPU restarts operation or not as selected in

Configuration > Run/Stop Control > Run/Stop Selection at Memory Backup Error. For details on SmartAXIS Pro/Lite start control, see "Run/Stop Selection at Memory Backup Error" on page 5-5.

M8001 1-sec Clock Reset

While M8001 is on, M8121 (1-sec clock) is turned off.

M8002 All Outputs OFF

When M8002 is turned on, all outputs and remote outputs go off until M8002 is turned off. Self-maintained circuits using outputs also go off and are not restored when M8002 is turned off.

M8003 Carry (Cy) and Borrow (Bw) [Ladder program only]

When a carry or borrow results from executing an addition or subtraction instruction, M8003 turns on. M8003 is also used for the bit shift and rotate instructions. For the causes of carry (CY) and borrow (BW), when ladder program is selected as the programming language, see Chapter 4 "Instructions Reference" – "Carry and Borrow" in the "SmartAXIS Ladder Programming Manual".

M8004 User Program Execution Error

When an error occurs while executing a user program, M8004 turns on. The cause of the user program execution error can be checked using **Online > Monitor > Monitor**, then **Online > Status > Error Status > Details**.

For a list of Pro/Lite user program execution errors, see "User Program Execution Error" on page 14-6.

M8005 Remote I/O Slave 1 Communication Error

When an error occurs during communication with remote I/O slave 1, M8005 turns on. When the error is cleared, M8005 turns off.

M8006 Remote I/O Slave 2 Communication Error

When an error occurs during communication with remote I/O slave 2, M8006 turns on. When the error is cleared, M8006 turns off.

M8007 Remote I/O Slave 3 Communication Error

When an error occurs during communication with remote I/O slave 3, M8007 turns on. When the error is cleared, M8007 turns off.

M8010 In Daylight Saving Time Period

When the daylight saving time is enabled, M8010 is turned on while in the daylight saving time period. When the daylight saving time is disabled, M8010 is always off.

M8013 Calendar/Clock Data Write/Adjust Error Flag

When an error occurs while calendar/clock data is written or clock data is adjusted, M8013 turns on. If calendar/clock data is written or clock data is adjusted successfully, M8013 turns off.

M8014 Calendar/Clock Data Read Error Flag

When an error occurs while calendar/clock data is read from the internal clock to the special data registers (D8008 to D8014), M8014 turns on. If calendar/clock data is read successfully, M8014 turns off.

M8016 Calendar Data Write Flag

When M8016 is turned on, data in data registers D8015 through D8018 (calendar new data) are set to the internal clock.

M8017 Clock Data Write Flag

When M8017 is turned on, data in data registers D8019 through D8021 (clock new data) are set to the internal clock.

M8020 Calendar/Clock Data Write Flag

When M8020 is turned on, data in data registers D8015 through D8021 (calendar/clock new data) are set to the internal clock.

M8021 Clock Data Adjust Flag

When M8021 is turned on, the clock is adjusted with respect to seconds. If *seconds* are between 0 and 29 for current time, adjustment for *seconds* will be set to 0 and *minutes* remain the same. If *seconds* are between 30 and 59 for current time, adjustment for *seconds* will be set to 0 and *minutes* are incremented by one.

M8022 User Communication Receive Instruction Cancel Flag (Port 2) [Ladder program only]

When M8022 is turned on, all RXD2 instructions ready for receiving user communication through port 2 are disabled.

This function cannot be used when FBD program is selected as the programming language.

M8023 User Communication Receive Instruction Cancel Flag (Port 3) [Ladder program only]

When M8023 is turned on, all RXD3 instructions ready for receiving user communication through port 3 are disabled.

This function cannot be used when FBD program is selected as the programming language.

M8024 BMOV/WSFT Executing Flag [Ladder program only]

While the BMOV or WSFT is executed, M8024 turns on. When completed, M8024 turns off. If the CPU is powered down while executing BMOV or WSFT, M8024 remains on when the CPU is powered up again.

This function cannot be used when FBD program is selected as the programming language.

M8025 Maintain Outputs While CPU Stopped

Outputs are normally turned off when the CPU is stopped. M8025 is used to maintain the output statuses when the CPU is stopped. When the CPU is stopped with M8025 turned on, the output ON/OFF statuses are maintained. When the CPU restarts, M8025 is turned off automatically.

M8026 SD Memory Card Status

When an SD memory card is inserted into the SmartAXIS, M8026 turns on. When an SD memory card is not inserted, M8026 turns off.

M8027 SD Memory Card Writing Flag

While logging data is written to the SD memory card, M8027 turns on. When writing logging data is finished, M8027 turns off.

M8030-M8061 Special Internal Relays for High-speed Counter

Special internal relays used for the high-speed counter.
 For details on the Pro/Lite high-speed counter, see "High-Speed Counter" on page 5-13.

M8070-M8075 Interrupt Input Status [Ladder program only]

Turns on when the corresponding user interrupt is allowed. When interrupt inputs are disabled, these internal relays are turned off.
 M8070=Interrupt input I0 status, M8071=Interrupt input I2 status, M8072=Interrupt input I3 status
 M8073=Interrupt input I5 status, M8074=Interrupt input I6 status, M8075=Interrupt input I7 status
 This function cannot be used when FBD program is selected as the programming language.

M8076 SD Memory Card Access Stop Flag

Access to the SD memory card is stopped when M8076 is turned off to on.

M8080-M8085 Interrupt Input Edge (ON: Rising, OFF: Falling) [Ladder program only]

This flag indicates whether the interrupt input is triggered with a rising edge or falling edge.
 This function cannot be used when FBD program is selected as the programming language.

M8090-M8095 Catch Input ON/OFF Status

When a rising or falling input edge is detected during a scan, the input statuses of catch inputs Group 1/I0 through Group 6/I7 at the moment are set to M8090 through M8095, respectively, without regard to the scan status. Only one edge is detected in one scan. For the catch input function, see "Catch Input" on page 5-32.

M8100-M8102 User Communication Receive Instruction Cancel Flag [Ladder program only]

When M8100, M8101, or M8102 is turned on, all ERXD instructions ready for receiving user communication through connection 1, connection 2, or connection 3 are disabled, respectively.
 This function cannot be used when FBD program is selected as the programming language.

M8110-M8112 Connection Status

When SmartAXIS and a network device are connected via the maintenance communication server, user communication server/client, or Modbus TCP server/client, the connection status turns on. When no network devices are connected, the connection status turns off.

These relays are always off for the 12-I/O type (SmartAXIS without Ethernet port).

M8120 Initialize Pulse

When the CPU starts operation, M8120 turns on for a period of one scan.

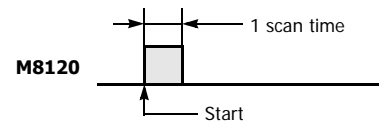

M8121 1-sec Clock

While M8001 (1-sec clock reset) is off, M8121 generates clock pulses in 1-sec increments, with a duty ratio of 1:1 (500ms on and 500ms off).

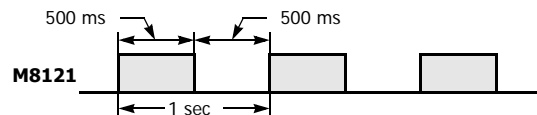

M8122 100-ms Clock

M8122 always generates clock pulses in 100ms increments, whether M8001 is on or off, with a duty ratio of 1:1 (50ms on and 50ms off).

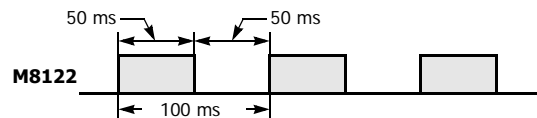

M8123 10-ms Clock

M8123 always generates clock pulses in 10ms increments, whether M8001 is on or off, with a duty ratio of 1:1 (5ms on and 5ms off).

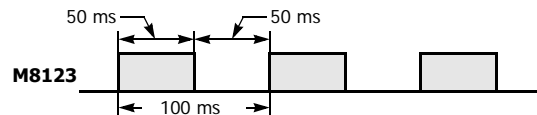

M8124 Timer/Counter Preset Value Changed

When timer or counter preset values are changed in the CPU module RAM, M8124 turns on. When a user program is downloaded to the CPU from WindLDR or when the changed timer/counter preset value is cleared, M8124 turns off.
 When a timer or counter is designated as a destination of an advanced instruction, the timer/counter preset value is also changed.

M8125 In-operation Output

M8125 remains on while the CPU is running.

M8130-M8132 Disconnect User Communication Connection [Ladder program only]

When SmartAXIS is connected to a remote host with the user communication client and a special internal relay corresponding to the connection is turned off to on, the connection is disconnected. This function cannot be used when FBD program is selected as the programming language. Special internal relays M8130 through M8132 are allocated to connections 1 through 3, respectively. These relays are enabled only when user communication client is used. These relays have no effect for the user communication server. Nothing happens for the 12-I/O type (SmartAXIS without Ethernet port) when these relays are turned on.

M8144 Timer Interrupt Status [Ladder program only]

When timer interrupt is enabled, M8144 is turned on. When disabled, M8144 is turned off. This function cannot be used when FBD program is selected as the programming language.

M8150 Comparison Result 1 [Ladder program only]

When the CMP= instruction is used, M8150 is turned on when the value of device designated by S1 is greater than that of device designated by S2 ($S1 > S2$). See Chapter 7 "Data Comparison Instructions" - "Special Internal Relays M8150, M8151, and M8152 in CMP=" in the "SmartAXIS Ladder Programming Manual".

When the ICMP>= instruction is used, M8150 is turned on when the value of device designated by S2 is greater than that of device designated by S1 ($S2 > S1$). See Chapter 7 "Data Comparison Instructions" - "Special Internal Relays M8150, M8151, and M8152 in ICMP>=" in the "SmartAXIS Ladder Programming Manual".

This function cannot be used when FBD program is selected as the programming language.

M8151 Comparison Result 2 [Ladder program only]

When the CMP= instruction is used, M8151 is turned on when the value of device designated by S1 is equal to that of device designated by S2 ($S1 = S2$). See Chapter 7 "Data Comparison Instructions" - "Special Internal Relays M8150, M8151, and M8152 in CMP=" in the "SmartAXIS Ladder Programming Manual".

When the ICMP>= instruction is used, M8151 is turned on when the value of device designated by S3 is greater than that of device designated by S2 ($S3 > S2$). See Chapter 7 "Data Comparison Instructions" - "Special Internal Relays M8150, M8151, and M8152 in ICMP>=" in the "SmartAXIS Ladder Programming Manual".

This function cannot be used when FBD program is selected as the programming language.

M8152 Comparison Result 3 [Ladder program only]

When the CMP= instruction is used, M8152 is turned on when the value of device designated by S1 is less than that of device designated by S2 ($S1 < S2$). See Chapter 7 "Data Comparison Instructions" - "Special Internal Relays M8150, M8151, and M8152 in CMP=" in the "SmartAXIS Ladder Programming Manual".

When the ICMP>= instruction is used, M8152 is turned on when the value of device designated by S2 is less than that of device designated by S1 and greater than that of device designated by S3 ($S1 > S2 > S3$). See Chapter 7 "Data Comparison Instructions" - "Special Internal Relays M8150, M8151, and M8152 in ICMP>=" in the "SmartAXIS Ladder Programming Manual".

This function cannot be used when FBD program is selected as the programming language.

M8154: Write Data Register values to ROM

This special internal relay is used for the data register ROM backup. When M8154 is on at the end of scan, the values of all data registers are written to ROM. After writing values, the execution status is stored in D8133 and M8154 turns off. For details, see Chapter 5 "Special Functions" – "Data Register ROM Backup" on page 5-9.

M8155: Read Data Register values from ROM

This special internal relay is used for the data register ROM backup. When M8155 turns on at the end of scan, the values in the corresponding ROM are read and stored in the data registers specified by D8184 (start address to read) and D8185 (number of registers to read). After reading values, the execution status is stored in D8133 and M8155 turns off. For details, see Chapter 5 "Special Functions" – "Data Register ROM Backup" on page 5-9.

M8160-M8163 Button Input Status

While the ESC button and direction buttons on the SmartAXIS Pro are simultaneously pressed, the corresponding special internal relays M8160 through M8163 turn on. When no buttons are pressed, M8160 through M8163 turn off.

M8166-M8177 Special Internal Relays for High-speed Counter

Special internal relays used for the high-speed counter.

For details on the Pro/Lite high-speed counter, see "High-Speed Counter" on page 5-13.

7: DEVICE ADDRESSES

Special Data Registers

Note: Do not change the data of reserved special data registers, otherwise the SmartAXIS may not operate correctly.

Special Data Register Device Addresses

Device Address	Description	Updated	Ladder	FBD	See Page	
D8000	Quantity of Inputs	When I/O initialized	X	X	7-11	
D8001	Quantity of Outputs	When I/O initialized	X	X	7-11	
D8002	SmartAXIS Type Information	Power-up	X	X	7-11	
D8003	Memory Cartridge Information	Power-up	X	X	7-11	
D8004	— Reserved —	—	—	—	—	
D8005	General Error Code	When error occurred	X	X	7-11	
D8006	User Program Execution Error Code	When error occurred	X	X	7-11	
D8007	— Reserved —	—	—	—	—	
D8008	Calendar/Clock Current Data (Read only)	Year	Every 500 ms	X	X	7-11
D8009		Month	Every 500 ms	X	X	7-11
D8010		Day	Every 500 ms	X	X	7-11
D8011		Day of Week	Every 500 ms	X	X	7-11
D8012		Hour	Every 500 ms	X	X	7-11
D8013		Minute	Every 500 ms	X	X	7-11
D8014		Second	Every 500 ms	X	X	7-11
D8015		Calendar/Clock New Data (Write only)	Year	—	X	X
D8016	Month		—	X	X	7-11
D8017	Day		—	X	X	7-11
D8018	Day of Week		—	X	X	7-11
D8019	Hour		—	X	X	7-11
D8020	Minute		—	X	X	7-11
D8021	Second		—	X	X	7-11
D8022	Scan Time Data		Constant Scan Time Preset Value (1 to 1,000 ms)	—	X	X
D8023		Scan Time Current Value (ms)	Every scan	X	X	7-11
D8024		Scan Time Maximum Value (ms)	At occurrence	X	X	7-11
D8025		Scan Time Minimum Value (ms)	At occurrence	X	X	7-11
D8026	Communication Mode Information (Port 2 and Port 3)	Every scan	X	X	7-12	
D8027	Port 2 Slave Number	Every scan	X	X	7-12	
D8028	Port 3 Slave Number	Every scan	X	X	7-12	
D8029	System Software Version	Power-up	X	X	7-12	
D8030	Communication Adapter Information	Power-up	X	X	7-12	
D8031	Optional Cartridge Information	Power-up	X	X	7-12	
D8032	Interrupt Input Jump Destination Label No. (I0)	—	X	—	7-12	
D8033	Interrupt Input Jump Destination Label No. (I2)	—	X	—	7-12	
D8034	Interrupt Input Jump Destination Label No. (I3)	—	X	—	7-12	
D8035	Interrupt Input Jump Destination Label No. (I5)	—	X	—	7-12	
D8036	Timer Interrupt Jump Destination Label No.	—	X	—	7-13	
D8037	Interrupt Input Jump Destination Label No. (I6)	—	X	—	7-12	
D8038	Interrupt Input Jump Destination Label No. (I7)	—	X	—	7-12	
D8039	SD Memory Card Capacity (Megabytes)	Every 1 sec	X	X	7-13	
D8040	Analog Input Value (A10)	Every scan	X	X	7-13	
D8041	Analog Input Value (A11)	Every scan	X	X	7-13	
D8042	Analog Input Value (A12)	Every scan	X	X	7-13	
D8043	Analog Input Value (A13)	Every scan	X	X	7-13	
D8044	Analog Input Value (A14)	Every scan	X	X	7-13	
D8045	Analog Input Value (A15)	Every scan	X	X	7-13	
D8046	Analog Input Value (A16)	Every scan	X	X	7-13	
D8047	Analog Input Value (A17)	Every scan	X	X	7-13	
D8048-D8049	— Reserved —	—	—	—	—	

Device Address	Description		Updated	Ladder	FBD	See Page	
D8050	High-speed Counter (Group 1/10)	High Word	Current Value / Frequency Measurement Value (10)	Every scan	X	X	7-13
D8051		Low Word			X	X	
D8052		High Word	Preset Value	—	X	X	7-13
D8053		Low Word			X	X	
D8054		High Word	Reset Value	—	X	X	7-13
D8055		Low Word			X	X	
D8056	High-speed Counter (Group 2/12)	High Word	Current Value / Frequency Measurement Value (12)	Every scan	X	X	7-13
D8057		Low Word			X	X	
D8058		High Word	Preset Value	—	X	X	7-13
D8059		Low Word			X	X	
D8060		High Word	Reset Value	—	X	X	7-13
D8061		Low Word			X	X	
D8062	High-speed Counter (Group 3/13)	High Word	Current Value / Frequency Measurement Value (13)	Every scan	X	X	7-13
D8063		Low Word			X	X	
D8064		High Word	Preset Value	—	X	X	7-13
D8065		Low Word			X	X	
D8066		High Word	Reset Value	—	X	X	7-13
D8067		Low Word			X	X	
D8068	High-speed Counter (Group 4/15)	High Word	Current Value / Frequency Measurement Value (15)	Every scan	X	X	7-13
D8069		Low Word			X	X	
D8070		High Word	Preset Value	—	X	X	7-13
D8071		Low Word			X	X	
D8072		High Word	Reset Value	—	X	X	7-13
D8073		Low Word			X	X	
D8074	Backlight ON Time		Every scan	X	X	7-13	
D8075-D8076	— Reserved —		—	—	—	—	
D8077	Out of Analog Input Range Status		—	X	X	7-13	
D8078	MAC Address (Read only)		Every 1 sec	X	X	7-13	
D8079				X	X		
D8080				X	X		
D8081				X	X		
D8082				X	X		
D8083				X	X		
D8084	IP Address (Current Data) Read only		Every 1 sec	X	X	7-13	
D8085				X	X		
D8086				X	X		
D8087				X	X		
D8088	Subnet Mask (Current Data) Read only		Every 1 sec	X	X	7-13	
D8089				X	X		
D8090				X	X		
D8091				X	X		
D8092	Default Gateway (Current Data) Read only		Every 1 sec	X	X	7-14	
D8093				X	X		
D8094				X	X		
D8095				X	X		
D8096-D8103	— Reserved —		—	—	—	—	
D8104	RS232C Control Signal Status (Ports 2 and 3)		Every scan	X	—	7-14	
D8105	RS232C DSR Input Control Signal Option (Ports 2 and 3)		When sending/ receiving data	X	—	7-14	
D8106	RS232C DTR Output Control Signal Option (Ports 2 and 3)		When sending/ receiving data	X	—	7-14	
D8107-D8109	— Reserved —		—	—	—	—	

7: DEVICE ADDRESSES

Device Address	Description		Updated	Ladder	FBD	See Page	
D8110	Connection 1 Connected IP Address		Every 1 sec	X	X	7-14	
D8111				X	X		
D8112				X	X		
D8113				X	X		
D8114	Connection 2 Connected IP Address		Every 1 sec	X	X	7-14	
D8115				X	X		
D8116				X	X		
D8117				X	X		
D8118	Connection 3 Connected IP Address		Every 1 sec	X	X	7-14	
D8119				X	X		
D8120				X	X		
D8121				X	X		
D8122-D8129	— Reserved —		—	—	—	—	
D8130	Connection 1 Connected Port Number		Every 1 sec	X	X	7-14	
D8131	Connection 2 Connected Port Number		Every 1 sec	X	X	7-14	
D8132	Connection 3 Connected Port Number		Every 1 sec	X	X	7-14	
D8133	Data Register ROM Backup	Execution Status	When executing data register ROM backup read and write	X	X	7-15	
D8134	High-speed Counter (Group 5/16)	High Word	Current Value / Frequency Measurement Value (16)	Every scan	X	X	7-13
D8135		Low Word			X	X	
D8136		High Word	Preset Value	—	X	X	7-13
D8137		Low Word					
D8138		High Word	Reset Value	—	X	X	7-13
D8139		Low Word					
D8140	High-speed Counter (Group 6/17)	High Word	Current Value / Frequency Measurement Value (17)	Every scan	X	X	7-13
D8141		Low Word			X	X	
D8142		High Word	Preset Value	—	X	X	7-13
D8143		Low Word					
D8144		High Word	Reset Value	—	X	X	7-13
D8145		Low Word					
D8146	— Reserved —		—	—	—	—	
D8147	— Reserved —		—	—	—	—	
D8148	Remote I/O Slave 1	Communication Error Status	When error occurred	X	X	7-15	
D8149		Analog Input (AI10)	Every scan	X	X	7-15	
D8150		Analog Input (AI11)	Every scan	X	X	7-15	
D8151		Analog Input (AI12)	Every scan	X	X	7-15	
D8152		Analog Input (AI13)	Every scan	X	X	7-15	
D8153		Analog Input (AI14)	Every scan	X	X	7-15	
D8154		Analog Input (AI15)	Every scan	X	X	7-15	
D8155		Analog Input (AI16)	Every scan	X	X	7-15	
D8156		Analog Input (AI17)	Every scan	X	X	7-15	
D8157		Remote I/O Slave 2	Communication Error Status	When error occurred	X	X	7-15
D8158	Analog Input (AI20)		Every scan	X	X	7-15	
D8159	Analog Input (AI21)		Every scan	X	X	7-15	
D8160	Analog Input (AI22)		Every scan	X	X	7-15	
D8161	Analog Input (AI23)		Every scan	X	X	7-15	
D8162	Analog Input (AI24)		Every scan	X	X	7-15	
D8163	Analog Input (AI25)		Every scan	X	X	7-15	
D8164	Analog Input (AI26)		Every scan	X	X	7-15	
D8165	Analog Input (AI27)		Every scan	X	X	7-15	

Device Address	Description		Updated	Ladder	FBD	See Page
D8166	Remote I/O Slave 3	Communication Error Status	When error occurred	X	X	7-15
D8167		Analog Input (AI30)	Every scan	X	X	7-15
D8168		Analog Input (AI31)	Every scan	X	X	7-15
D8169		Analog Input (AI32)	Every scan	X	X	7-15
D8170		Analog Input (AI33)	Every scan	X	X	7-15
D8171		Analog Input (AI34)	Every scan	X	X	7-15
D8172		Analog Input (AI35)	Every scan	X	X	7-15
D8173		Analog Input (AI36)	Every scan	X	X	7-15
D8174		Analog Input (AI37)	Every scan	X	X	7-15
D8175-D8183		— Reserved —		—	—	—
D8184	Data Register	Start Address to Read	—	X	X	7-15
D8185	ROM Backup	Number of Registers to Read	—	X	X	7-15
D8186-D8199	— Reserved —		—	—	—	—

D8000 Quantity of Inputs

The total of input points provided on the SmartAXIS is stored to D8000.

D8001 Quantity of Outputs

The total of output points provided on the SmartAXIS is stored to D8001.

D8002 SmartAXIS Type Information

Information about the SmartAXIS type is stored to D8002.

- 0:** SmartAXIS Pro/Lite 12-I/O type
- 1:** SmartAXIS Pro/Lite 24-I/O type
- 2:** SmartAXIS Pro/Lite 40-I/O type
- 3:** SmartAXIS Pro/Lite 48-I/O type
- 4:** SmartAXIS Touch

D8003 Memory Cartridge Information

When an optional memory cartridge is installed on the SmartAXIS cartridge connector, information about the user program stored on the memory cartridge is stored to D8003.

- 0:** SmartAXIS Pro/Lite 12-I/O type
- 1:** SmartAXIS Pro/Lite 24-I/O type
- 2:** SmartAXIS Pro/Lite 40-I/O type
- 3:** SmartAXIS Pro/Lite 48-I/O type
- 255:** The memory cartridge does not store any user program.

D8005 General Error Code

SmartAXIS general error information is stored to D8005. When a general error occurs, the bit corresponding to the error occurred turns on.

The general error and user program execution error can be cleared by writing "1" to the most significant bit of D8005.

For details on Touch general error codes, see "Troubleshooting" on page 14-1.

D8006 User Program Execution Error Code

SmartAXIS user program execution error information is stored to D8006. When a user program execution error occurs, the error code corresponding to the error occurred is stored to D8006.

For details on Pro/Lite user program execution error codes, see "User Program Execution Error" on page 14-6.

D8008-D8021 Calendar/Clock Data

D8008 through D8021 are used for reading calendar/clock data from the internal clock and for writing calendar/clock data to the internal clock.

D8022-D8025 Scan Time Data

D8022 through D8025 are special data registers for checking the scan time and configuring the constant scan time.

For details on the SmartAXIS Pro/Lite scan time, see "Constant Scan Time" on page 5-67.

7: DEVICE ADDRESSES

D8026 Communication Mode Information (Port 2 and Port 3)

Communication mode information of port 2 and port 3 is stored in D8026.

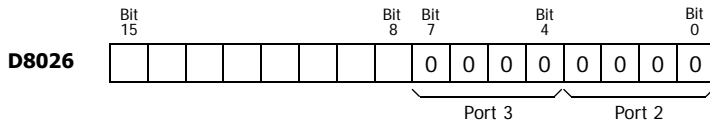

- 0: Maintenance Communication
- 1: User Communication
- 2: Modbus RTU Master
- 3: Modbus RTU Slave

D8027-D8028 Slave Number

The slave number is stored in D8027 and D8028 when the communication mode of port 2 and 3 is maintenance communication or Modbus RTU slave.

The slave number can be specified with either a constant or a data register in the function area settings. When data register is specified, the slave number can be changed by storing the slave number in D8027 and D8028.

D8027: Port 2 Slave Number

D8028: Port 3 Slave Number

For SmartAXIS Pro/Lite maintenance communication, see "Maintenance Communication via Expansion Communication Port" on page 9-3. For Modbus RTU slaves, see "Modbus Communication via RS-232C/RS-485" on page 11-1.

D8029 System Software Version

The PLC system software version number is stored to D8029. This value is indicated in the PLC status dialog box called from the WindLDR menu bar. Select **Online > Monitor > Monitor**, then select **Online > Status**. See "Troubleshooting" on page 14-1.

D8030 Communication Adapter Information

Information about the communication adapters installed on the port 2 and port 3 connectors is stored to D8030.

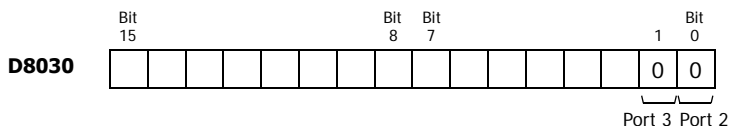

- 0: RS232C communication adapter is installed
- 1: RS485 communication adapter is installed or no communication adapter is installed

D8031 Optional Cartridge Information

Information about the optional cartridge installed on the SmartAXIS is stored to D8031.

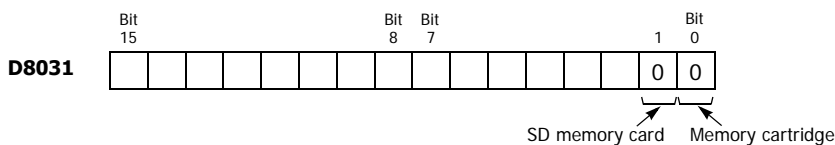

- 0: No optional cartridge is installed
- 1: Memory cartridge is installed
- 2: SD memory card is installed
- 3: Memory cartridge and SD memory card are installed

D8032-D8035, D8037, D8038 Interrupt Input Jump Destination Label No. [Ladder program only]

Jump destination label numbers for interrupt inputs are stored in these special data registers. To use interrupt inputs, store the label number that corresponds to the special data register allocated to the interrupt input.

D8032=I0, D8033=I2, D8034=I3, D8035=I5, D8037=I6, D8038=I7

This function cannot be used when FBD program is selected as the programming language.

For details on SmartAXIS Pro/Lite interrupt inputs, see "Interrupt Input" on page 5-34.

D8036 Timer Interrupt Jump Destination Label No. [Ladder program only]

The jump destination label number when the timer interrupt occurs is stored in D8036. To use the timer interrupt, store the corresponding label number.

This function cannot be used when FBD program is selected as the programming language.

For details on the SmartAXIS Pro/Lite timer interrupt, see "Timer Interrupt" on page 5-41.

D8039 SD Memory Card Capacity

The capacity of the inserted SD or SDHC (maximum size 32GB) memory card in megabytes is stored in D8039.

D8040-D8047 Analog Input Value

The analog input values (0 to 10V DC) to the analog input terminals are converted to digital values (0 to 1000) and stored in the corresponding special data registers.

When the programming language is FBD, the linear conversion can be configured for each analog input (AI). Even when the linear conversion is configured for the analog inputs, the special data registers store the analog values (0 to 1000) before the linear conversion is applied.

D8040=AI0, D8041=AI1, D8042=AI2, D8043=AI3, D8044=AI4, D8045=AI5, D8046=AI6, D8047=AI7

D8050-D8073, D8134-D8145 High-speed Counter

These special data registers are used with the high-speed counter function and the frequency measurement function.

For details on the SmartAXIS Pro/Lite high-speed counter, see "High-Speed Counter" on page 5-13.

D8074 Backlight ON Time

The backlight ON time is stored. The backlight ON time can be configured by changing the value in D8074 between 1 to 65535 seconds. When D8074 is 0, the backlight is always ON. The backlight ON time can also be changed with the HMI function. For details, see "Backlight ON Time" on page 5-57.

D8077 Analog Input Out of Range Status

When an analog input value is 11V or higher, the corresponding bit of D8077 turns on. When an analog input value is lower than 11V, the corresponding bit of D8077 turns off.

The assignment of each analog input is as follows.

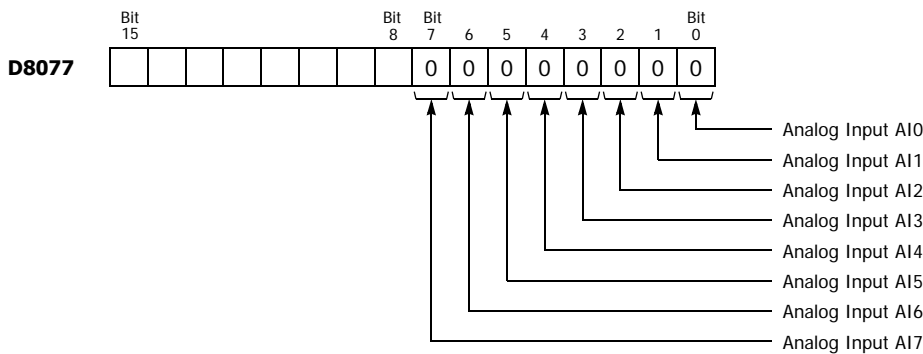

D8078-D8083 MAC Address (Read only)

MAC address of the SmartAXIS is stored in the special data registers in hexadecimal as shown below.

Example) MAC address: AA-BB-CC-DD-EE-FF

D8078=AAh, D8079=BBh, D8080=CCh, D8081=DDh, D8082=EEh, D8083=FFh

D8084-D8087 IP Address (Current Data) Read only

IP address of the SmartAXIS is stored in the special data registers as shown below.

Example) IP address: aaa.bbb.ccc.ddd

D8084=aaa, D8085=bbb, D8086=ccc, D8087=ddd

D8088-D8091 Subnet Mask (Current Data) Read only

Subnet mask of the SmartAXIS is stored in the special data registers as shown below.

Example) Subnet mask: aaa.bbb.ccc.ddd

D8088=aaa, D8089=bbb, D8090=ccc, D8091=ddd

D8133 Data Register ROM Backup Execution Status

This special data register is used for the data register ROM backup. Stores the execution status for writing and reading.

- 1: Processing
- 2: Normal termination
- 3: Cannot access ROM
- 4: Invalid values are stored in D8184 (starting address to read) and D8185 (number of registers to read)
- 5: Valid data could not be read from ROM

For details, see Chapter 5 "Special Functions" – "Data Register ROM Backup" on page 5-9.

D8148, D8157, D8166 Remote I/O Communication Error Status

When a communication error occurs between the remote I/O communication slave and master, the details of the communication error are stored in these special data registers.

D8148 : Remote I/O Slave 1 Communication Error Status

D8157 : Remote I/O Slave 2 Communication Error Status

D8166 : Remote I/O Slave 3 Communication Error Status

D8149-D8156, D8158-D8165, D8167-D8174 Remote I/O Analog Input Values

The analog input values (0 to 10 VDC) to the remote I/O analog inputs are converted to digital values (0 to 1000) and stored in the special data registers allocated to each remote I/O slave.

When the programming language is FBD, the linear conversion can be configured for each analog input (AI). Even when the linear conversion is configured for the analog inputs, the special data registers store the analog values (0 to 1000) before the linear conversion is applied.

- D8149=AI10, D8150=AI11, D8151=AI12, D8152=AI13, D8153=AI14, D8154=AI15, D8155=AI16, D8156=AI17
- D8158=AI20, D8159=AI21, D8160=AI22, D8161=AI23, D8162=AI24, D8163=AI25, D8164=AI26, D8165=AI27
- D8167=AI30, D8168=AI31, D8169=AI32, D8170=AI33, D8171=AI34, D8172=AI35, D8173=AI36, D8174=AI37

D8184 Data Register ROM Backup Start Address to Read

This special data register is used for the data register ROM backup and stores the start address of the data registers to read.

For details, see Chapter 5 "Special Functions" – "Data Register ROM Backup" on page 5-9.

D8185 Data Register ROM Backup Number of Registers to Read

This special data register is used for the data register ROM backup and stores the number of data registers to read.

For details, see Chapter 5 "Special Functions" – "Data Register ROM Backup" on page 5-9.

8: INSTRUCTIONS/FUNCTION BLOCKS REFERENCE

Introduction

The SmartAXIS provides dedicated instruction set for each programming language.

The instructions for ladder programs are divided into basic instructions, which perform sequencing, and advanced instructions, which perform moves, comparisons, Boolean computations, binary arithmetic operations, bit shifts, and other operations. For details, see the SmartAXIS Ladder Programming Manual.

A series of function blocks are provided for FBD programming such as logical operation function blocks that perform logical operations, timer/counter function blocks to perform processing using timers and counter devices, and pulse output function blocks that perform pulse output.

Ladder Program Instructions List

This section lists the ladder program instructions and describes their functions divided into basic instructions and advanced instructions.

Basic Instruction List

Symbol	Name	Function
AND	And	Series connection of NO contact
AND LOD	And Load	Series connection of circuit blocks
ANDN	And Not	Series connection of NC contact
BPP	Bit Pop	Restores the result of bit logical operation which was saved temporarily
BPS	Bit Push	Saves the result of bit logical operation temporarily
BRD	Bit Read	Reads the result of bit logical operation which was saved temporarily
CC=	Counter Comparison (=)	Equal to comparison of counter current value
CC>=	Counter Comparison (>=)	Greater than or equal to comparison of counter current value
CDP	Dual Pulse Reversible Counter	Dual pulse reversible counter (0 to 65,535)
CDPD	Double-word Dual Pulse Reversible Counter	Double-word dual pulse reversible counter (0 to 4,294,967,295)
CNT	Adding Counter	Adding counter (0 to 65,535)
CNTD	Double-word Adding Counter	Double-word adding counter (0 to 4,294,967,295)
CUD	Up/Down Selection Reversible Counter	Up/down selection reversible counter (0 to 65,535)
CUDD	Double-word Up/Down Selection Reversible Counter	Double-word up/down selection reversible counter (0 to 4,294,967,295)
DC=	Data Register Comparison (=)	Equal to comparison of data register value
DC>=	Data Register Comparison (>=)	Greater than or equal to comparison of data register value
END	End	Ends a program
JEND	Jump End	Ends a jump instruction
JMP	Jump	Jumps a designated program area
LOD	Load	Stores intermediate results and reads contact status
LODN	Load Not	Stores intermediate results and reads inverted contact status
MCR	Master Control Reset	Ends a master control
MCS	Master Control Set	Starts a master control
OR	Or	Parallel connection of NO contact
OR LOD	Or Load	Parallel connection of circuit blocks
ORN	Or Not	Parallel connection of NC contact
OUT	Output	Outputs the result of bit logical operation
OUTN	Output Not	Outputs the inverted result of bit logical operation
RST	Reset	Resets output, internal relay, or shift register bit
SET	Set	Sets output, internal relay, or shift register bit
SFR	Shift Register	Forward shift register

8: INSTRUCTIONS/FUNCTION BLOCKS REFERENCE

Symbol	Name	Function
SFRN	Shift Register Not	Reverse shift register
SOTD	Single Output Down	Falling-edge differentiation output
SOTU	Single Output Up	Rising-edge differentiation output
TIM	100-ms Timer	Subtracting 100-ms timer (0 to 6553.5 sec)
TIMO	100-ms Off-delay Timer	Subtracting 100-ms off-delay timer (0 to 6553.5 sec)
TMH	10-ms Timer	Subtracting 10-ms timer (0 to 655.35 sec)
TMHO	10-ms Off-delay Timer	Subtracting 10-ms off-delay timer (0 to 655.35 sec)
TML	1-sec Timer	Subtracting 1-sec timer (0 to 65535 sec)
TMLO	1-sec Off-delay Timer	Subtracting 1-sec off-delay timer (0 to 65535 sec)
TMS	1-ms Timer	Subtracting 1-ms timer (0 to 65.535 sec)
TMSO	1-ms Off-delay Timer	Subtracting 1-ms off-delay timer (0 to 65.535 sec)

Advanced Instruction List

Group	Symbol	Name	Valid Data Type				
			W	I	D	L	F
NOP	NOP	No Operation					
Move	MOV	Move	X	X	X	X	X
	MOVN	Move Not	X	X	X	X	
	IMOV	Indirect Move	X		X		X
	IMOVN	Indirect Move Not	X		X		
	BMOV	Block Move	X				
	IBMV	Indirect Bit Move	X				
	IBMVN	Indirect Bit Move Not	X				
	NSET	N Data Set	X	X	X	X	X
	NRS	N Data Repeat Set	X	X	X	X	X
	XCHG	Exchange	X		X		
TCCST	Timer/Counter Current Value Store	X		X			
Data Comparison	CMP=	Compare Equal To	X	X	X	X	X
	CMP<>	Compare Unequal To	X	X	X	X	X
	CMP<	Compare Less Than	X	X	X	X	X
	CMP>	Compare Greater Than	X	X	X	X	X
	CMP<=	Compare Less Than or Equal To	X	X	X	X	X
	CMP>=	Compare Greater Than or Equal To	X	X	X	X	X
	ICMP>=	Interval Compare Greater Than or Equal To	X	X	X	X	X
	LC=	Load Compare Equal To	X	X	X	X	X
	LC<>	Load Compare Unequal To	X	X	X	X	X
	LC<	Load Compare Less Than	X	X	X	X	X
	LC>	Load Compare Greater Than	X	X	X	X	X
	LC<=	Load Compare Less Than or Equal To	X	X	X	X	X
LC>=	Load Compare Greater Than or Equal To	X	X	X	X	X	
Binary Arithmetic	ADD	Addition	X	X	X	X	X
	SUB	Subtraction	X	X	X	X	X
	MUL	Multiplication	X	X	X	X	X
	DIV	Division	X	X	X	X	X
	INC	Increment	X	X	X	X	
	DEC	Decrement	X	X	X	X	
	ROOT	Root	X		X		X
	SUM	Sum (ADD) Sum (XOR)	X X	X	X	X	X
Boolean Computation	ANDW	AND Word	X		X		
	ORW	OR Word	X		X		
	XORW	Exclusive OR Word	X		X		
Shift and Rotate	SFTL	Shift Left					
	SFTR	Shift Right					
	BCDLS	BCD Left Shift			X		
	WSFT	Word Shift	X				
	ROTL	Rotate Left	X		X		
	ROTR	Rotate Right	X		X		

*X" indicates that the instruction is supported.

8: INSTRUCTIONS/FUNCTION BLOCKS REFERENCE

Group	Symbol	Name	Valid Data Type				
			W	I	D	L	F
Data Conversion	HTOB	Hex to BCD	X		X		
	BTOH	BCD to Hex	X		X		
	HTOA	Hex to ASCII	X				
	ATOH	ASCII to Hex	X				
	BTOA	BCD to ASCII	X		X		
	ATOB	ASCII to BCD	X		X		
	ENCO	Encode					
	DECO	Decode					
	BCNT	Bit Count					
	ALT	Alternate Output					
	CVDT	Convert Data Type	X	X	X	X	X
	DTDV	Data Divide	X				
	DTCB	Data Combine	X				
SWAP	Data Swap	X		X			
Week Programmer	WEEK	Weekly Timer					
	YEAR	Yearly Timer					
Interface	MSG	Message					
User Communication	TXD2	Transmit 2					
	TXD3	Transmit 3					
	RXD2	Receive 2					
	RXD3	Receive 3					
Program Branching	LABEL	Label					
	LJMP	Label Jump					
	LCAL	Label Call					
	LRET	Label Return					
	DJNZ	Decrement Jump Non-zero					
	DI	Disable Interrupt					
	EI	Enable Interrupt					
	IREF	I/O Refresh					
HSCRF	High-speed Counter Refresh						
Coordinate Conversion	XYFS	XY Format Set	X	X			
	CVXTY	Convert X to Y	X	X			
	CVYTX	Convert Y to X	X	X			
	AVRG	Average	X	X	X	X	X
Pulse	PULS1	Pulse Output 1					
	PULS2	Pulse Output 2					
	PULS3	Pulse Output 3					
	PULS4	Pulse Output 4					
	PWM1	Pulse Width Modulation 1					
	PWM2	Pulse Width Modulation 2					
	PWM3	Pulse Width Modulation 3					
	PWM4	Pulse Width Modulation 4					
	RAMP1	Ramp Pulse Output 1					
	RAMP2	Ramp Pulse Output 2					
	ZRN1	Zero Return 1					
	ZRN2	Zero Return 2					
	ARAMP1	Advanced Ramp 1					
	ARAMP2	Advanced Ramp 2					
Dual / Teaching Timer	DTML	1-sec Dual Timer					
	DTIM	100-ms Dual Timer					
	DTMH	10-ms Dual Timer					
	DTMS	1-ms Dual Timer					
	TTIM	Teaching Timer					

"X" indicates that the instruction is supported.

8: INSTRUCTIONS/FUNCTION BLOCKS REFERENCE

Group	Symbol	Name	Valid Data Type				
			W	I	D	L	F
Trigonometric Function	RAD	Degree to Radian					X
	DEG	Radian to Degree					X
	SIN	Sine					X
	COS	Cosine					X
	TAN	Tangent					X
	ASIN	Arc Sine					X
	ACOS	Arc Cosine					X
	ATAN	Arc Tangent					X
Logarithm / Power	LOGE	Natural Logarithm					X
	LOG10	Common Logarithm					X
	EXP	Exponent					X
	POW	Power					X
File Data Processing	FIFO	FIFO Format	X				
	FIEX	First-In Execute	X				
	FOEX	First-Out Execute	X				
	NDSRC	N Data Search	X	X	X	X	X
Clock	TADD	Time Addition					
	TSUB	Time Subtraction					
	HTOS	HMS to Sec					
	STOH	Sec to HMS					
	HOUR	Hour Meter					
Ethernet Instructions	ETXD	Transmit over Ethernet					
	ERXD	Receive over Ethernet					
Data Logging	DLOG	Data Log					
	TRACE	Data Trace					
Script Instructions	SCRPT	Script					

"X" indicates that the instruction is supported.

Advanced Instruction Applicable SmartAXIS

Applicable advanced instructions depend on the type of SmartAXIS as listed in the table below.

Group	Symbol	FT1A-12		FT1A-24		FT1A-40		FT1A-48	
		AC	DC	AC	DC	AC	DC	AC	DC
NOP	NOP	X	X	X	X	X	X	X	X
Move	MOV	X	X	X	X	X	X	X	X
	MOVN	X	X	X	X	X	X	X	X
	IMOV	X	X	X	X	X	X	X	X
	IMOVN	X	X	X	X	X	X	X	X
	BMOV	X	X	X	X	X	X	X	X
	IBMV	X	X	X	X	X	X	X	X
	IBMVN	X	X	X	X	X	X	X	X
	NSET	X	X	X	X	X	X	X	X
	NRS	X	X	X	X	X	X	X	X
	XCHG	X	X	X	X	X	X	X	X
TCCST	X	X	X	X	X	X	X	X	
Data Comparison	CMP=	X	X	X	X	X	X	X	X
	CMP<>	X	X	X	X	X	X	X	X
	CMP<	X	X	X	X	X	X	X	X
	CMP>	X	X	X	X	X	X	X	X
	CMP<=	X	X	X	X	X	X	X	X
	CMP>=	X	X	X	X	X	X	X	X
	ICMP>=	X	X	X	X	X	X	X	X
	LC=	X	X	X	X	X	X	X	X
	LC<>	X	X	X	X	X	X	X	X
	LC<	X	X	X	X	X	X	X	X
	LC>	X	X	X	X	X	X	X	X
	LC<=	X	X	X	X	X	X	X	X
LC>=	X	X	X	X	X	X	X	X	
Binary Arithmetic	ADD	X	X	X	X	X	X	X	X
	SUB	X	X	X	X	X	X	X	X
	MUL	X	X	X	X	X	X	X	X
	DIV	X	X	X	X	X	X	X	X
	INC	X	X	X	X	X	X	X	X
	DEC	X	X	X	X	X	X	X	X
	ROOT	X	X	X	X	X	X	X	X
SUM	X	X	X	X	X	X	X	X	
Boolean Computation	ANDW	X	X	X	X	X	X	X	X
	ORW	X	X	X	X	X	X	X	X
	XORW	X	X	X	X	X	X	X	X
Shift and Rotate	SFTL	X	X	X	X	X	X	X	X
	SFTR	X	X	X	X	X	X	X	X
	BCDLS	X	X	X	X	X	X	X	X
	WSFT	X	X	X	X	X	X	X	X
	ROTL	X	X	X	X	X	X	X	X
	ROTR	X	X	X	X	X	X	X	X

"X" indicates that the instruction is supported.

8: INSTRUCTIONS/FUNCTION BLOCKS REFERENCE

Group	Symbol	FT1A-12		FT1A-24		FT1A-40		FT1A-48		FT1A-Touch
		AC	DC	AC	DC	AC	DC	AC	DC	
Data Conversion	HTOB	X	X	X	X	X	X	X	X	X
	BTOH	X	X	X	X	X	X	X	X	X
	HTOA	X	X	X	X	X	X	X	X	X
	ATOH	X	X	X	X	X	X	X	X	X
	BTOA	X	X	X	X	X	X	X	X	X
	ATOB	X	X	X	X	X	X	X	X	X
	ENCO	X	X	X	X	X	X	X	X	X
	DECO	X	X	X	X	X	X	X	X	X
	BCNT	X	X	X	X	X	X	X	X	X
	ALT	X	X	X	X	X	X	X	X	X
	CVDT	X	X	X	X	X	X	X	X	X
	DTDV	X	X	X	X	X	X	X	X	X
	DTCB	X	X	X	X	X	X	X	X	X
	SWAP	X	X	X	X	X	X	X	X	X
Week Programmer	WEEK	X	X	X	X	X	X	X	X	X
	YEAR	X	X	X	X	X	X	X	X	X
Interface	MSG	X (Note)	X (Note)	X (Note)	X (Note)	X (Note)	X (Note)	X (Note)	X (Note)	
User Communication	TXD2			X	X	X	X	X	X	
	TXD3					X	X	X	X	
	RXD2			X	X	X	X	X	X	
	RXD3					X	X	X	X	
Program Branching	LABEL	X	X	X	X	X	X	X	X	X
	LJMP	X	X	X	X	X	X	X	X	X
	LCAL	X	X	X	X	X	X	X	X	X
	LRET	X	X	X	X	X	X	X	X	X
	DJNZ	X	X	X	X	X	X	X	X	X
	DI	X	X	X	X	X	X	X	X	X
	EI	X	X	X	X	X	X	X	X	X
	IOREF	X	X	X	X	X	X	X	X	X
HSCRF		X		X		X		X	X	
Coordinate Conversion	XYFS	X	X	X	X	X	X	X	X	X
	CVXTY	X	X	X	X	X	X	X	X	X
	CVYTX	X	X	X	X	X	X	X	X	X
	AVRG	X	X	X	X	X	X	X	X	X

Note: MSG instructions can be used with Pro series only.

"X" indicates that the instruction is supported.

8: INSTRUCTIONS/FUNCTION BLOCKS REFERENCE

Group	Symbol	FT1A-12		FT1A-24		FT1A-40		FT1A-48		FT1A-Touch
		AC	DC	AC	DC	AC	DC	AC	DC	
Pulse	PULS1						X	X	X	
	PULS2						X	X	X	
	PULS3						X (Note1)	X	X	
	PULS4						X (Note1)	X	X	
	PWM1						X	X	X	
	PWM2						X	X	X	
	PWM3						X (Note1)	X	X	
	PWM4						X (Note1)	X	X	
	RAMP1						X	X	X	
	RAMP2						X (Note2)	X (Note2)	X (Note2)	
	ZRN1						X	X	X	
	ZRN2						X	X	X	
	ARAMP1						X	X	X	
ARAMP2						X (Note2)	X (Note2)	X (Note2)		
Dual / Teaching Timer	DTML	X	X	X	X	X	X	X	X	X
	DTIM	X	X	X	X	X	X	X	X	X
	DTMH	X	X	X	X	X	X	X	X	X
	DTMS	X	X	X	X	X	X	X	X	X
	TTIM	X	X	X	X	X	X	X	X	X
Trigonometric Function	RAD	X	X	X	X	X	X	X	X	X
	DEG	X	X	X	X	X	X	X	X	X
	SIN	X	X	X	X	X	X	X	X	X
	COS	X	X	X	X	X	X	X	X	X
	TAN	X	X	X	X	X	X	X	X	X
	ASIN	X	X	X	X	X	X	X	X	X
	ACOS	X	X	X	X	X	X	X	X	X
	ATAN	X	X	X	X	X	X	X	X	X
Logarithm / Power	LOGE	X	X	X	X	X	X	X	X	X
	LOG10	X	X	X	X	X	X	X	X	X
	EXP	X	X	X	X	X	X	X	X	X
	POW	X	X	X	X	X	X	X	X	X
File Data Processing	FIFO	X	X	X	X	X	X	X	X	X
	FIEX	X	X	X	X	X	X	X	X	X
	FOEX	X	X	X	X	X	X	X	X	X
	NDSRC	X	X	X	X	X	X	X	X	X
Clock	TADD	X	X	X	X	X	X	X	X	X
	TSUB	X	X	X	X	X	X	X	X	X
	HTOS	X	X	X	X	X	X	X	X	X
	STOH	X	X	X	X	X	X	X	X	X
	HOUR	X	X	X	X	X	X	X	X	X
Ethernet Instructions	ETXD			X	X	X	X	X	X	
	ERXD			X	X	X	X	X	X	
Data Logging	DLOG					X	X	X	X	
	TRACE					X	X	X	X	
Script Instructions	SCRPT	X	X	X	X	X	X	X	X	X

Note 1: When using RAMP1 in single-pulse output mode, PULS3 and PWM3 cannot be used. When using RAMP2 in single-pulse output mode, PULS4 and PWM4 cannot be used.

Note 2: When using RAMP1 or ARAMP1 in dual-pulse output mode, RAMP2 or ARAMP2 cannot be used.

"X" indicates that the instruction is supported.

FB List

This section lists the SmartAXIS FBs and describes their functions. For details, see the "SmartAXIS FBD Programming Manual".

Input FB

This section describes the input FB of the SmartAXIS and its functions.

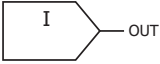
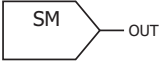
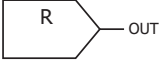
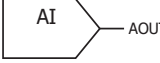
Symbol	Name and Diagram	Function	Output inversion	FBD manual page
I	Digital Input 	Inputs ON/OFF information from an external device to the SmartAXIS.	–	5-1
M	Special Internal Relay 	Special internal relays can be used as bit inputs for function blocks. Special function is allocated to each special internal relay. For details on the individual special internal relays, see Chapter 7 "Device Addresses" - "Special Internal Relays" on page 7-2.	–	5-2
R	Shift Register 	Outputs ON/OFF state of a shift register device.	–	5-3
AI	Analog Input 	The analog input values (0 to 10V DC) for the analog input terminals are converted to digital values (0 to 1,000) and output. With the analog input linear transformation function, the analog input value can be linearly transformed within a range of -32,768 to 32,767.	–	5-4

Output FB

This section describes the output FB of the SmartAXIS and its functions.

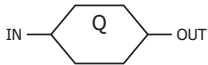
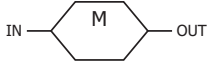
Symbol	Name and Diagram	Function	Output inversion	FBD manual page
Q	Digital Output 	Outputs ON/OFF information from the SmartAXIS to an external device.	–	6-1
M	Internal Relay 	A bit unit function block used internally by the SmartAXIS.	–	6-2

8: INSTRUCTIONS/FUNCTION BLOCKS REFERENCE

Logical Operation FB

This section describes the logical operation FB of the SmartAXIS and its functions. The logical operation FB performs logical operations on input signals and output the result.

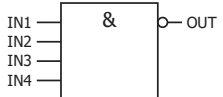
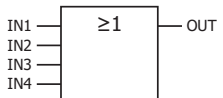
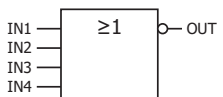
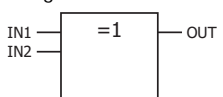
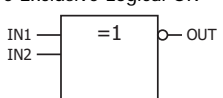
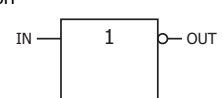
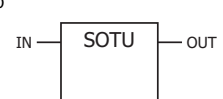
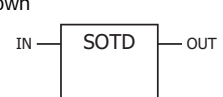
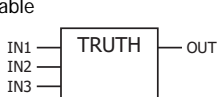
Symbol	Name and Diagram	Function	Output inversion	FBD manual page
AND	Logical AND 	Finds logical AND for a maximum of four input signals (ON/OFF) and outputs the result.	–	7-1
NAND	Negative Logical AND 	Finds negative logical AND for a maximum of four input signals (ON/OFF) and outputs the result.	–	7-2
OR	Logical OR 	Finds logical OR for a maximum of four input signals (ON/OFF) and outputs the result.	–	7-3
NOR	Negative Logical OR 	Finds negative logical OR for a maximum of four input signals (ON/OFF) and outputs the result.	–	7-4
XOR	Exclusive Logical OR 	Finds negative logical OR for a maximum of four input signals (ON/OFF) and outputs the result.	–	7-5
XNOR	Negative Exclusive Logical OR 	Finds negative exclusive logical OR for a maximum of two input signals (ON/OFF) and outputs the result.	–	7-6
NOT	Negation 	Outputs the result of negating the input signal (ON/OFF).	–	7-7
SOTU	Shot up 	Turns on the output for one scan when the input signal changes from off to on.	–	7-8
SOTD	Shot down 	Turns on the output for one scan when the input signal changes from on to off.	–	7-9
TRUTH	Truth Table 	The output against 16 bit patterns of the four input signals can be configured as a truth table, and the output turns on or off according to those settings.	X	7-10

Timer FB

This section describes the timer FB of the SmartAXIS and its functions. The timer FB uses the timer to compare the current value and the preset value and output the result.

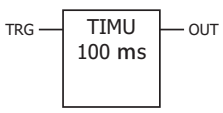
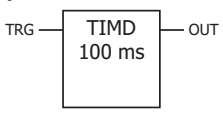
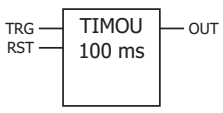
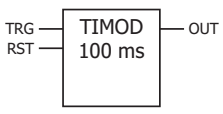
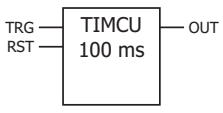
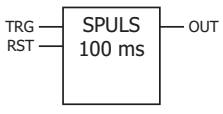
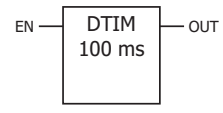
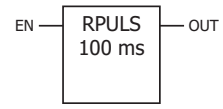
Symbol	Name and Diagram	Function	Output inversion	FBD manual page
TIMU	On-delay Count Up Timer 	After the execution input turns on, the output turns on when the on-delay time elapses. The current value is incremented from zero to the preset value.	–	8-1
TIMD	On-delay Count Down Timer 	After the execution input turns on, the output turns on when the on-delay time elapses. The current value is decremented from the preset value to zero.	–	8-5
TIMOU	Off-delay Count Up Timer 	When the execution input is on, the output turns on. After the execution input turns off, the output turns off when the off-delay time elapses. The current value is incremented from zero to the preset value.	–	8-7
TIMOD	Off-delay Count Down Timer 	When the execution input is on, the output turns on. After the execution input turns off, the output turns off when the off-delay time elapses. The current value is decremented from the preset values to zero.	–	8-9
TIMCU	On/off-delay Timer 	After the execution input turns on, the output turns on when the on-delay time elapses. When the execution input turns on, the output turns off when the off-delay time elapses.	–	8-11
SPULS	Single Shot Pulse 	After the execution input turns on, the output turns on for the configured time.	–	8-14
DTIM	Dual Timer 	The output is turned on and off according to the configured ON and OFF time.	–	8-16
RPULS	Random Pulse Output 	The output is randomly turned on for the configured range of time.	–	8-19

8: INSTRUCTIONS/FUNCTION BLOCKS REFERENCE

Counter FB

This section describes the counter FB of the SmartAXIS and its functions. The counter FB uses the counter to compare the count value and the preset value and output the result.

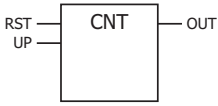
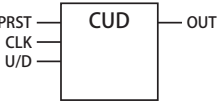
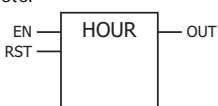
Symbol	Name and Diagram	Function	Output inversion	FBD manual page
CNT	Adding Counter 	When the clock input is turned on, the current value is incremented by one. The output turns on when the current value reaches the preset value.	-	9-1
CUD	Up/Down Selection Reversible Counter 	When the clock input is turned on, the current value is incremented or decremented by one according to the up/down selection input. The current value is compared with ON/OFF thresholds. The output turns on or off according to the comparison result.	-	9-3
HOUR	Hour Meter 	Accumulates the ON duration of the input in hours, minutes, and seconds. The output turns on when the accumulated time reaches the configured time.	-	9-7

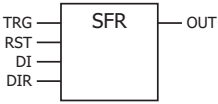

Shift Register FB

This section describes the shift register FB of the SmartAXIS and its functions.

Symbol	Name and Diagram	Function	Output inversion	FBD manual page
SFR	Shift Register 	With the rise of the execution input, the shift registers are shifted to the specified shift direction.	X	10-1

Data Comparison FB

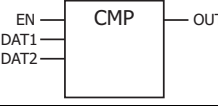
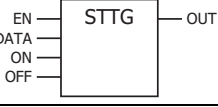
This section describes the data comparison FB of the SmartAXIS and its functions. The data comparison FB compares device values, analog values, or constants and output the result.

Symbol	Name and Diagram	Function	Output inversion	FBD manual page
CMP	Data Comparison 	Two values are compared and the output turns on or off according to the comparison result.	X	11-1
STTG	Schmitt Trigger 	The comparison value and the ON/OFF thresholds are compared and the output turns on or off according to the comparison result.	X	11-3
RCMP	Range Comparison 	The comparison value and the upper/lower limits are compared and the output turns on or off according to the comparison result.	X	11-5



Data Conversion FB

This section describes the data conversion FB of the SmartAXIS and its functions.

Symbol	Name and Diagram	Function	Output inversion	FBD manual page
ALT	Alternate Output 	Sets/resets the output.	X	12-1

Week Programmer FB

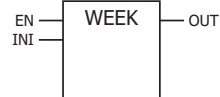
This section describes the week programmer FB of the SmartAXIS and its functions. The week programmer FB uses the internal clock of the SmartAXIS to control the output according to the specified date and time.

Symbol	Name and Diagram	Function	Output inversion	FBD manual page
WEEK	Weekly Timer 	Compares the specified day of the week, ON time, and OFF time with the current time and outputs the result.	-	13-1
YEAR	Yearly Timer 	Compares the specified date and the current date and outputs the result.	-	13-13

Interface FB

This section describes the interface FB of the SmartAXIS and its functions.

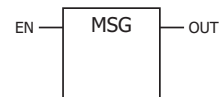
Symbol	Name and Diagram	Function	Output inversion	FBD manual page
MSG	Message 	Displays data such as text and device values on the LCD on the SmartAXIS Pro.	X	14-1

8: INSTRUCTIONS/FUNCTION BLOCKS REFERENCE

Pulse Output FB

This section describes the pulse output FB of the SmartAXIS and its functions. The pulse output FB outputs pulses from the pulse output port according to the specified settings.

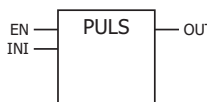
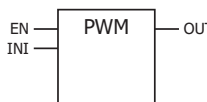
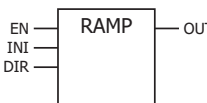
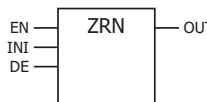
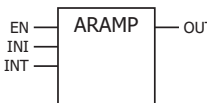
Symbol	Name and Diagram	Function	Output inversion	FBD manual page
PULS	Pulse Output 	Outputs pulses at the specified frequency.	X	15-1
PWM	Pulse Width Modulation 	Outputs pulses at the specified frequency and duty cycle.	X	15-6
RAMP	Ramp Pulse Output 	Outputs pulses with the frequency change function.	X	15-11
ZRN	Zero Return 	Outputs pulses while the proximity signal is off.	X	15-21
ARMP	Advanced Ramp 	Output pulses with the frequency change function according to the settings configured in the frequency table.	X	15-26

Data Logging FB

This section describes the data Logging FB of the SmartAXIS and its functions. The data Logging FB saves log data for devices to the SD memory card.

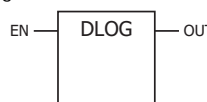
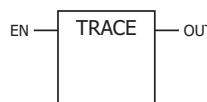
Symbol	Name and Diagram	Function	Output inversion	FBD manual page
DLOG	Data Log 	Saves the values of the specified devices in the specified data format as a CSV file on the SD memory card.	-	16-1
TRACE	Data Trace 	Saves the values of the previous number of scans for the specified device in the specified data format as a CSV file on the SD memory card.	-	16-8

Script FB

This section describes the script FB of the SmartAXIS and its functions.

Symbol	Name and Diagram	Function	Output inversion	FBD manual page
SCRPT	Script 	Enables you to program complicated processing with the script language that supports conditional branching, logical operations, arithmetic operations, and functions.	-	17-1

Special FB

This section describes the special FB of the SmartAXIS and its functions.

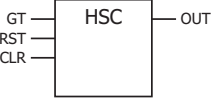
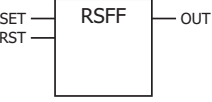
Symbol	Name and Diagram	Function	Output inversion	FBD manual page
HSC	High-speed Counter 	Operates the high-speed counter configured in the function area settings. Turns on/off the high-speed counter gate input/reset input.	X	18-1
RSFF	RS Flip-flop 	With the rise of the set input, the output turns on and is maintained. When the reset input turns on, the output is reset.	X	18-3

8: INSTRUCTIONS/FUNCTION BLOCKS REFERENCE

Advanced Instruction Applicable SmartAXIS

Function blocks			Applicable SmartAXIS							
			FT1A-12		FT1A-24		FT1A-40		FT1A-48	
Group	Name	Symbol	AC	DC	AC	DC	AC	DC	AC	DC
Input	Digital Input	I	X	X	X	X	X	X	X	X
	Special Internal Relay	M	X	X	X	X	X	X	X	X
	Shift Register	R	X	X	X	X	X	X	X	X
	Analog Input	AI	X	X	X	X	X	X	X	X
Output	Digital Output	Q	X	X	X	X	X	X	X	X
	Internal Relay	M	X	X	X	X	X	X	X	X
Logical Operation	Logical AND	AND	X	X	X	X	X	X	X	X
	Negative Logical AND	NAND	X	X	X	X	X	X	X	X
	Logical OR	OR	X	X	X	X	X	X	X	X
	Negative Logical OR	NOR	X	X	X	X	X	X	X	X
	Exclusive Logical OR	XOR	X	X	X	X	X	X	X	X
	Negative Exclusive Logical OR	XNOR	X	X	X	X	X	X	X	X
	Negation	NOT	X	X	X	X	X	X	X	X
	Shot up	SOTU	X	X	X	X	X	X	X	X
	Shot down	SOTD	X	X	X	X	X	X	X	X
	Truth Table	TRUTH	X	X	X	X	X	X	X	X
Timer	On-delay Count Up Timer	TIMU	X	X	X	X	X	X	X	X
	On-delay Count Down Timer	TIMD	X	X	X	X	X	X	X	X
	Off-delay Count Up Timer	TIMOU	X	X	X	X	X	X	X	X
	Off-delay Count Down Timer	TIMOD	X	X	X	X	X	X	X	X
	On/off-delay Timer	TIMCU	X	X	X	X	X	X	X	X
	Single Shot Pulse	SPULS	X	X	X	X	X	X	X	X
	Dual Timer	DTIM	X	X	X	X	X	X	X	X
	Random Pulse Output	RPULS	X	X	X	X	X	X	X	X
Counter	Adding Counter	CNT	X	X	X	X	X	X	X	X
	Up/Down Selection Reversible Counter	CUD	X	X	X	X	X	X	X	X
	Hour Meter	HOUR	X	X	X	X	X	X	X	X
Shift Register	Shift Register	SFR	X	X	X	X	X	X	X	
Data Comparison	Data Comparison	CMP	X	X	X	X	X	X	X	X
	Schmitt Trigger	STTG	X	X	X	X	X	X	X	X
	Range Comparison	RCMP	X	X	X	X	X	X	X	X
Data Conversion	Alternate Output	ALT	X	X	X	X	X	X	X	
Week Programmer	Weekly Timer	WEEK	X	X	X	X	X	X	X	X
	Yearly Timer	YEAR	X	X	X	X	X	X	X	X
Interface	Message	MSG	X (Note 1)	X (Note 1)	X (Note 1)	X (Note 1)	X (Note 1)	X (Note 1)	X (Note 1)	X (Note 1)
Pulse	Pulse Output	PULS	—	—	—	—	—	X (Note 2)	X	X
	Pulse Width Modulation	PWM	—	—	—	—	—	X (Note 2)	X	X
	Ramp Pulse Output	RAMP	—	—	—	—	—	X (Note 3)	X (Note 3)	X (Note 3)
	Zero Return	ZRN	—	—	—	—	—	X	X	X
	Advanced Ramp	ARMP	—	—	—	—	—	X (Note 3)	X (Note 3)	X (Note 3)
Data Logging	Data Log	DLOG	—	—	—	—	X	X	X	X
	Data Trace	TRACE	—	—	—	—	X	X	X	X
Script	Script	SCRPT	X	X	X	X	X	X	X	
Special	High-speed Counter	HSC	—	X	—	X	—	X	—	X
	RS Flip-flop	RSFF	X	X	X	X	X	X	X	X

Note 1: The MSG FB can be used only with SmartAXIS Pro.

Note 2: When using RAMP1 in single-pulse output mode, PULS3 and PWM3 cannot be used. When using RAMP2 in single-pulse output mode, PULS4 and PWM4 cannot be used.

Note 3: When using RAMP1 or ARAMP1 in dual-pulse output mode, RAMP2 or ARAMP2 cannot be used.

Applicable Data Types

Function blocks			Data type				
Group	Name	Symbol	W Word	I Integer	D Double word	L Long	F Float
Input	Digital Input	I	—	—	—	—	—
	Special Internal Relay	M	—	—	—	—	—
	Shift Register	R	—	—	—	—	—
	Analog Input	AI	—	X	—	—	—
Output	Digital Output	Q	—	—	—	—	—
	Internal Relay	M	—	—	—	—	—
Logical Operation	Logical AND	AND	—	—	—	—	—
	Negative Logical AND	NAND	—	—	—	—	—
	Logical OR	OR	—	—	—	—	—
	Negative Logical OR	NOR	—	—	—	—	—
	Exclusive Logical OR	XOR	—	—	—	—	—
	Negative Exclusive Logical OR	XNOR	—	—	—	—	—
	Negation	NOT	—	—	—	—	—
	Shot up	SOTU	—	—	—	—	—
	Shot down	SOTD	—	—	—	—	—
	Truth Table	TRUTH	—	—	—	—	—
Timer	On-delay Count Up Timer	TIMU	X	—	—	—	—
	On-delay Count Down Timer	TIMD	X	—	—	—	—
	Off-delay Count Up Timer	TIMOU	X	—	—	—	—
	Off-delay Count Down Timer	TIMOD	X	—	—	—	—
	On/off-delay Timer	TIMCU	X	—	—	—	—
	Single Shot Pulse	SPULS	X	—	—	—	—
	Dual Timer	DTIM	X	—	—	—	—
	Random Pulse Output	RPULS	X	—	—	—	—
Counter	Adding Counter	CNT	X	—	X	—	—
	Up/Down Selection Reversible Counter	CUD	X	—	X	—	—
	Hour Meter	HOURL	X	—	—	—	—
Shift Register	Shift Register	SFR	—	—	—	—	
Data Comparison	Data Comparison	CMP	X	X	X	X	—
	Schmitt Trigger	STTG	X	X	X	X	—
	Range Comparison	RCMP	X	X	X	X	—
Data Conversion	Alternate Output	ALT	—	—	—	—	
Week Programmer	Weekly Timer	WEEK	—	—	—	—	—
	Yearly Timer	YEAR	—	—	—	—	—
Interface	Message	MSG	X	X	X	X	X
Pulse	Pulse Output	PULS	—	—	—	—	—
	Pulse Width Modulation	PWM	—	—	—	—	—
	Ramp Pulse Output	RAMP	—	—	—	—	—
	Zero Return	ZRN	—	—	—	—	—
	Advanced Ramp	ARMP	—	—	—	—	—
Data Logging	Data Log	DLOG	X	X	X	X	X
	Data Trace	TRACE	X	X	X	X	X
Script	Script	SCRPT	X	X	X	X	X
Special	High-speed Counter	HSC	X	—	X	—	—
	RS Flip-flop	RSFF	—	—	—	—	—

9: MAINTENANCE COMMUNICATION

Introduction

This chapter describes the SmartAXIS maintenance communication function.

Maintenance communication is a communication protocol dedicated for IDEC programmable controllers. It is used when WindLDR or an IDEC operator interface communicates with the SmartAXIS.

Maintenance communication of SmartAXIS is available on USB port (WindLDR only), expansion communication ports, and Ethernet port, allowing the optimum communication method to be selected for a variety of system configurations.

Maintenance Communication Functions

When performing maintenance communication with the SmartAXIS, the following functions can be used:

Function	Description
Download user programs	User programs created in WindLDR can be downloaded to the SmartAXIS. See "Download Program" on page 4-14.
Upload user programs	User programs stored in the SmartAXIS can be uploaded to WindLDR.
Monitor/change device values	The user program and the device values of the SmartAXIS can be monitored and the device values can be changed using WindLDR. See "Monitor Operation" on page 4-15.
Download system software	System software can be downloaded to the SmartAXIS. See "Upgrade SmartAXIS System Software" on page A-2.

Note: To use maintenance communication, see "Start WindLDR" on page 4-1 and perform setup.

Communication Ports Used For Maintenance Communication

SmartAXIS supports the following communication ports:

Type	USB Port (Port 1)	Expansion Communication Ports (Note)		Ethernet Port
		Port 2	Port 3	
12-I/O type	Yes	No	No	No
24-I/O type	Yes	Yes	No	Yes
40-I/O type	Yes	Yes	Yes	Yes
48-I/O type	Yes	Yes	Yes	Yes

Note: Communication cartridges are required in order to use expansion communication ports.

Maintenance communication supports the following functions on each communication port:

Communication Port	Standard/Option	No. of Ports	Communication Settings
USB port	Standard	1	None
Expansion communication ports	Options FT1A-PC1: EIA RS232C (Mini DIN) FT1A-PC2: EIA RS485 (Mini DIN) FT1A-PC3: EIA RS485 (Terminal block)	12-I/O type: 0 24-I/O type: 1 40-I/O type: 2 48-I/O type: 2	Function area settings See "Maintenance Communication via Expansion Communication Port" on page 9-3.
Ethernet Port	12-I/O type: - 24-I/O type: Standard 40-I/O type: Standard 48-I/O type: Standard	1	Function area settings See "Maintenance Communication via Ethernet Port" on page 9-5.

Communication Port	Maintenance Communication Functions		
	Monitor/Change Device Values	Download/Upload User Programs	Download System Software
USB port	Yes	Yes	Yes
Expansion communication ports	Yes	No	No
Ethernet port	Yes	Yes	No

Maintenance Communication via USB Port

Applicable SmartAXIS

FT1A-12	FT1A-24	FT1A-40	FT1A-48
X	X	X	X

Using the USB port, it is possible to connect SmartAXIS to a computer on which WindLDR is installed, and monitor and change device values, download and upload user programs, and download system software. Connect the computer and the SmartAXIS using a USB cable (recommended cable: HG9Z-XCM42).

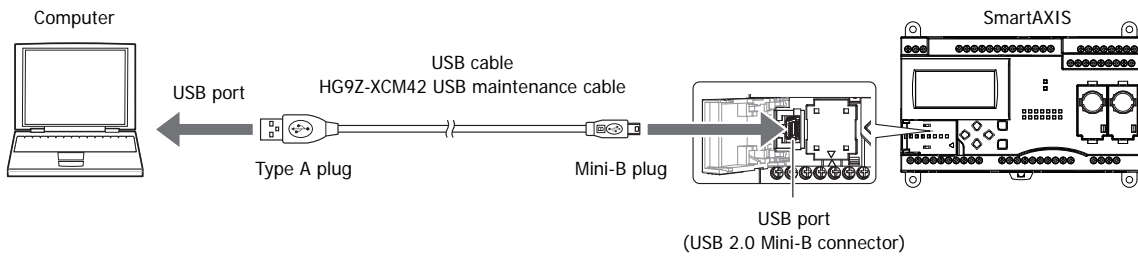

Maintenance Communication Specifications for the USB Port

Item	Specifications/Functions
Cable	Recommended cable: HG9Z-XCM42
Maintenance communication functions	Monitor/change device values Download/upload user programs Download system software

See the following pages for details on each maintenance communication function:

- Monitor/change device values: "Monitor Operation" on page 4-15
- Download/upload user programs: "Download Program" on page 4-14
- Download system software: "Upgrade SmartAXIS System Software" on page A-2

Maintenance Communication via Expansion Communication Port

Applicable SmartAXIS

FT1A-12	FT1A-24	FT1A-40	FT1A-48
—	X (Port 2)	X (Port 2 and 3)	X (Port 2 and 3)

By installing an RS232C or RS485 communication cartridge to a expansion communication port on the SmartAXIS, it is possible to connect SmartAXIS to a computer or an operator interface with an RS232C or RS485 port, and monitor and change device values of SmartAXIS.

For details on communication cables, see "Cables" on page A-8.

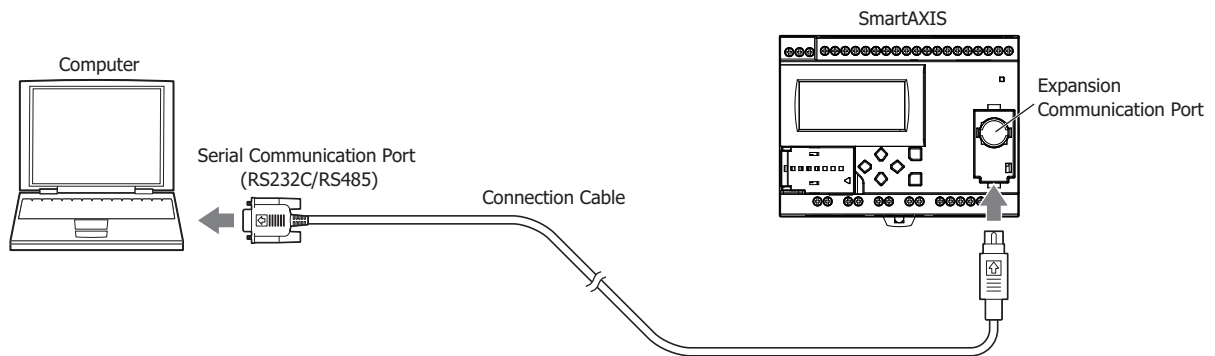

Maintenance Communication Specifications for Expansion Communication Ports

Item	Specifications/ Functions
Communication cartridge	FT1A-PC1: RS232C communication cartridge (Mini DIN type) FT1A-PC2: RS485 communication cartridge (Mini DIN type) FT1A-PC3: RS485 communication cartridge (Terminal block type) (Note)
Cable	FC2A-KC4C: RS232C communication cable (Mini DIN type) FC2A-KP1C: RS485 communication cable (Mini DIN type)
Maintenance communication functions	Monitoring/changing device values

Note: Use shielded twisted-pair cables.

See the following pages for details on the maintenance communication function:

- Monitor/change device values: "Monitor Operation" on page 4-15

Programming WindLDR

Configure the settings for maintenance communication.

Setting Procedure

1. From the WindLDR menu bar, select **Configuration > Comm. Ports**.
The Function Area Settings dialog box appears.

9: MAINTENANCE COMMUNICATION

- In the **Communication Mode** pull-down list for Port 2, select **Maintenance Protocol**.
The Maintenance Communication (Port 2) dialog box appears.

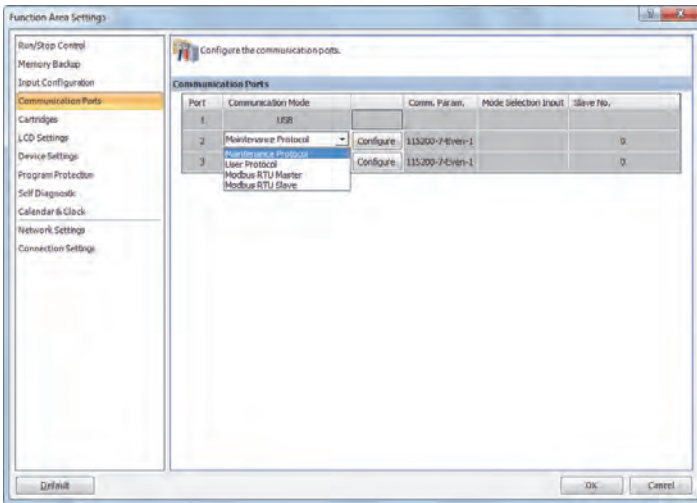

- Configure the parameters to match the communication settings of the computer or operator interface.

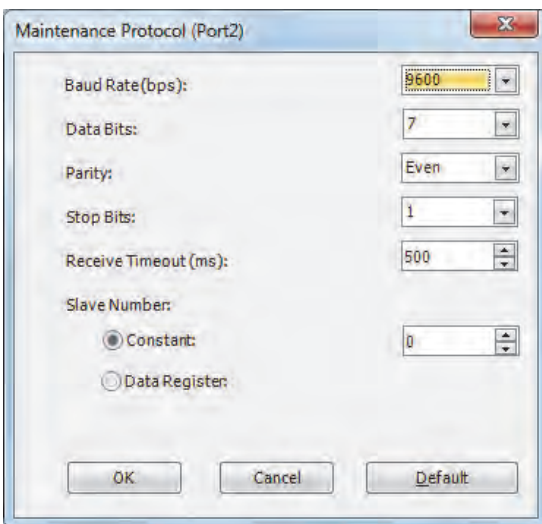

Baud Rate (bps):	115200bps (1200, 2400, 4800, 9600, 19200, 38400, 57600, 115200)
Data Bits:	7 (7 or 8)
Parity:	Even (None, Even, Odd)
Stop Bits:	1 (1 or 2)
Receive Timeout (ms):	500 (10 to 2550)
Slave Number	0 (0 to 31)

Slave number can be specified by either a constant or a data register.

Type	Details
Constant	Set within the range of 0 to 31
Data register	Store the slave numbers 0 to 31 in the following special data registers Port 2: D8027 Port 3: D8028

Notes:

- Values not in parentheses are the default settings.
- The following configuration cannot be selected: Data Bits: 7, Parity: None

- Click **OK**.
Configuring the maintenance communication for the expansion communication port is now complete.

Maintenance Communication via Ethernet Port

Applicable SmartAXIS

FT1A-12	FT1A-24	FT1A-40	FT1A-48
—	X	X	X

Network devices such as computers or IDEC operator interfaces can communicate with SmartAXIS via Ethernet. External devices on the network can monitor or change the device values and download or upload user programs.

It is possible to use the maintenance communication server and other communications simultaneously by assigning a separate communication function such as a maintenance communication server or Modbus TCP communication to each of the three connections on the SmartAXIS.

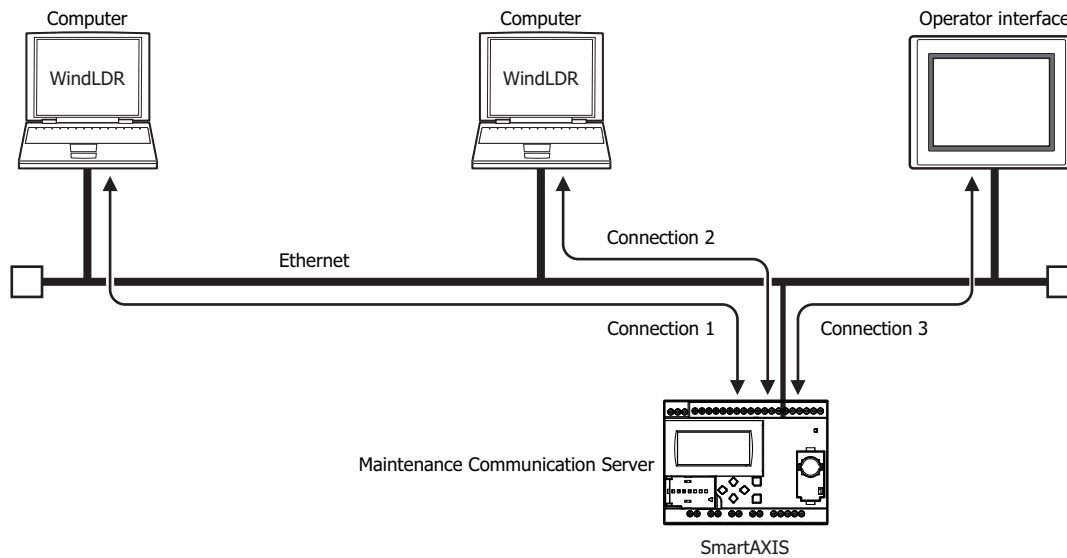

Maintenance Communication Specifications for the Ethernet Port

Item	Specifications/Functions
Cable	LAN cable
Maintenance communication functions	Monitor/change device values Download/upload user programs

See the following pages for details on each maintenance communication function:

- Monitor/change device values: "Monitor Operation" on page 4-15
- Download/upload user programs: "Download Program" on page 4-14

Programming WindLDR

This section describes the procedures to configure the maintenance communication server for the Ethernet port and communicate with the SmartAXIS via Ethernet.

Configure Maintenance Communication Server

1. From the WindLDR menu bar, select **Configuration > Network Settings**.
The Function Area Settings dialog box appears.
2. Enter the IP address, subnet mask, and default gateway.

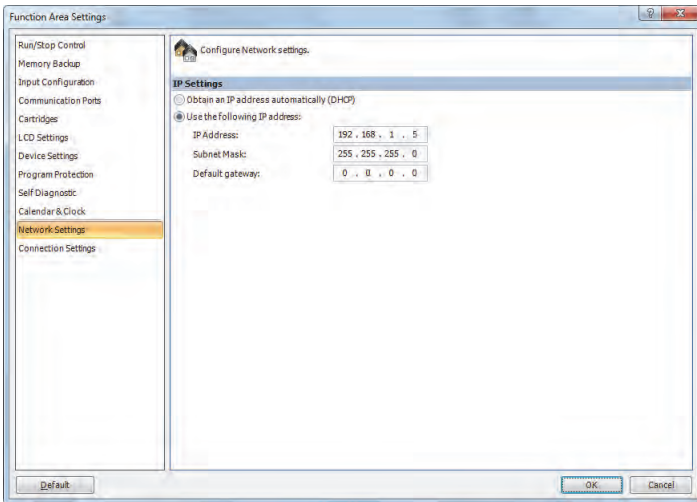

3. Click **Connection Settings**.
4. In the **Communication Mode** pull-down list for the connection to configure, select **Maintenance Communication Server**.
The Maintenance Communication Server dialog box appears.

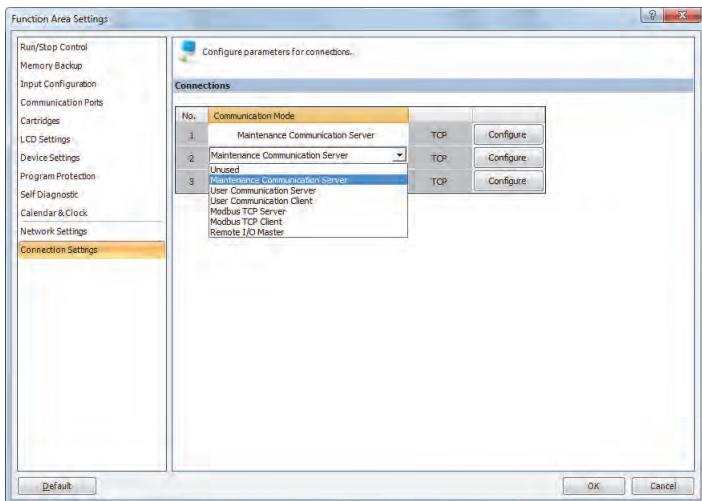

5. Set the parameters to match the communication settings of the PC or operator interface.

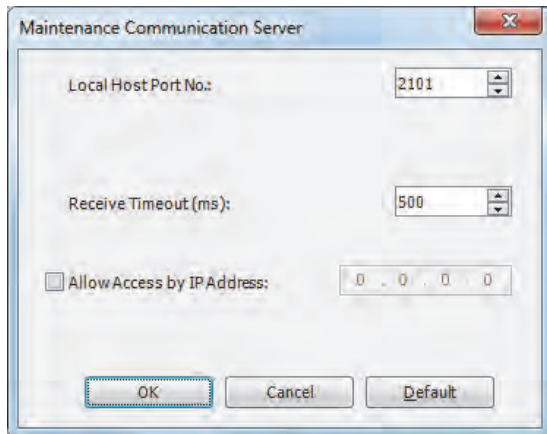

Local Host Port No.:	2101 (The port number that the SmartAXIS uses for the maintenance communication server)
Receive Timeout (ms):	2000 (100 to 25500ms)
Allow Access by IP Address:	Disabled (Enabling this option makes it possible to prevent access from devices having any IP addresses other than the one entered.)

Notes:

- Settings not in parentheses are the default values.
- The number of clients that can be connected to the SmartAXIS simultaneously is one client per connection. If connections 1 to 3 are all set to the maintenance communication server, three clients can connect to the SmartAXIS at the same time.

6. Click **OK**.
This completes maintenance communications settings.

Download User Program and Confirm IP Addresses via USB Port

Before starting Ethernet communication, configure the function area settings and download the user program to the SmartAXIS via USB.

7. Connect the PC and the SmartAXIS using a USB cable.
8. From the WindLDR menu bar, select **Online > Transfer > Download**.
The Download dialog box appears.

9: MAINTENANCE COMMUNICATION

9. Click **OK**.

The user program is downloaded to the SmartAXIS.

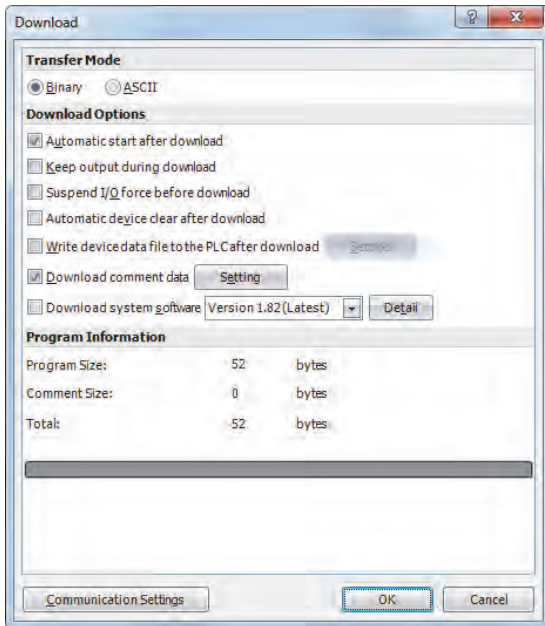

10. After the user program has been successfully downloaded, go to Monitor Mode to check the status of the SmartAXIS. Select **Online > Monitor > Monitor** from the WindLDR menu bar.

11. From the WindLDR menu bar, select **Online > Monitor > Batch**.

The Batch Monitor dialog box appears.

12. Confirm that the IP address entered in step 2 is correctly shown in D8084 to D8087.

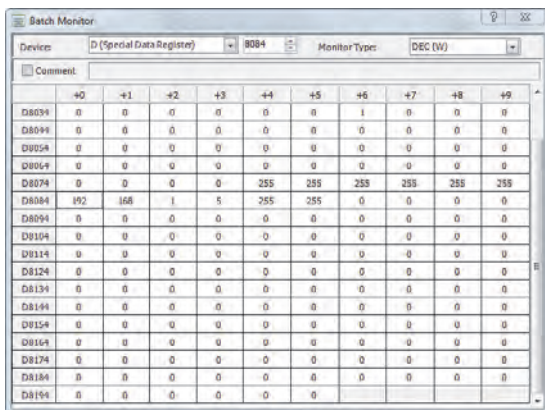

Monitor SmartAXIS via the Ethernet

Monitor the SmartAXIS via Ethernet using WindLDR.

13. From the WindLDR menu bar, select **Online > Communication > Set Up**.

The Communication Settings dialog box appears.

14. Select the **Ethernet** tab and click **Browse**.
The IP Address Settings dialog box appears.

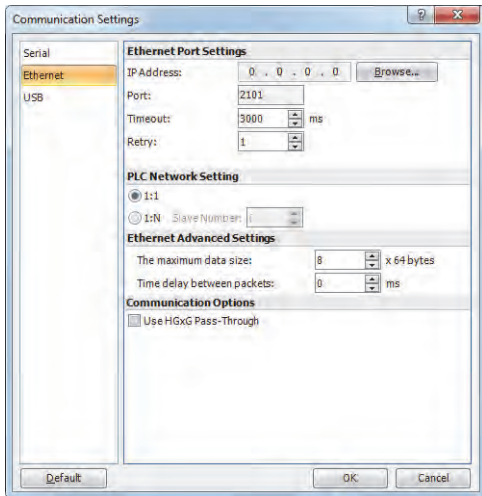

15. Click **New**.
The Input IP Address dialog box appears.

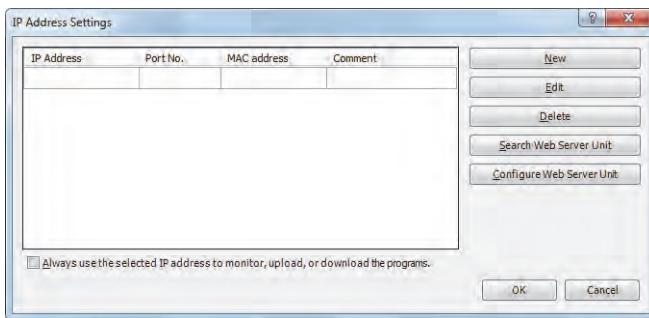

16. Enter the IP address entered in step 2 and click **OK**.

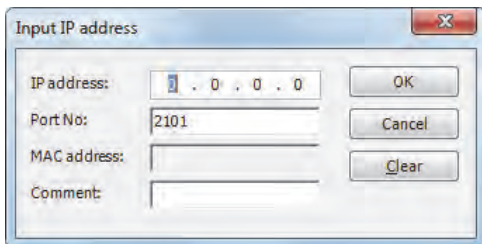

17. From the WindLDR menu bar, select **Online > Monitor > Monitor**.
The IP Address Settings dialog box appears.

18. Select the IP address you entered and click **OK**.

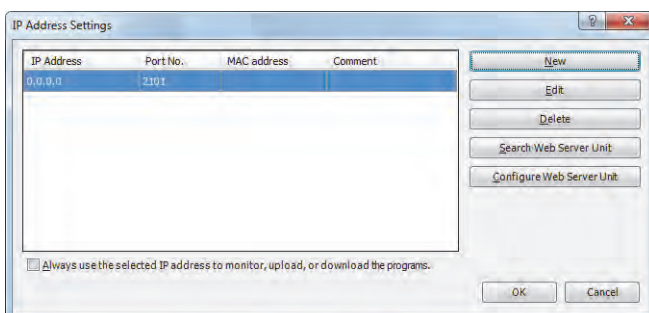

9: MAINTENANCE COMMUNICATION

19. From the WindLDR menu bar, select **Online > PLC > Status**.

The PLC Status dialog box appears.

20. Check that the SmartAXIS module type and system software version are displayed correctly.

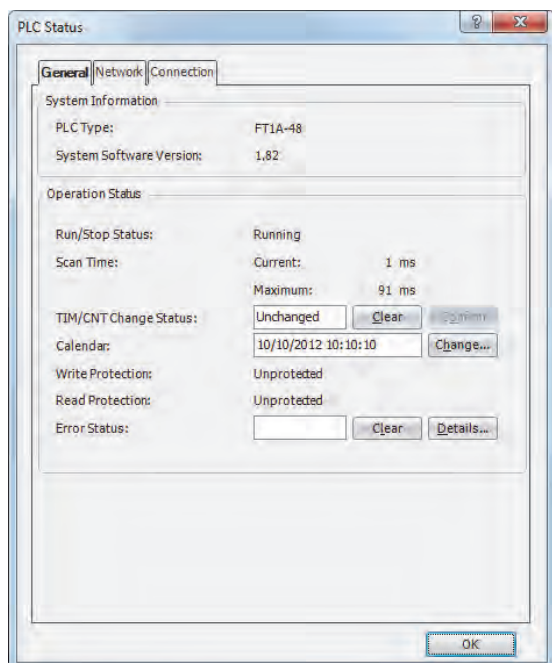

Configuring the initial Ethernet setup for the maintenance communication server is now complete. You can download and upload user programs and monitor and change device values via Ethernet.

10: USER COMMUNICATION INSTRUCTIONS

Introduction

This chapter describes user communication that converts the specified data to the data type for the external devices connected to the SmartAXIS and sends and receives that data.

User communication allows the following two types of communication methods:

- Serial communication with an external device connected to the RS232C port or the RS485 port
- Ethernet communication with an external device connected by the Ethernet port

User Communication via Serial Communication

This section describes the user communication function for communication between the SmartAXIS and external devices with an RS232C or RS485 port, such as a computer, modem, printer, or barcode reader. The SmartAXIS uses user communication instructions for transmitting and receiving communication to and from external devices.

User Communication Overview

By installing a communication cartridge on the SmartAXIS expansion communication port, the SmartAXIS can communicate with two external devices simultaneously.

When using an RS485 communication cartridge, SmartAXIS modules can communicate with a maximum of 31 RS485 devices using the user communication.

User communication transmit and receive instructions can be programmed to match the communication protocol of the equipment to communicate with. Possibility of communication using the user communication mode can be determined referring to the user communication mode specifications described below.

User Communication Mode Specifications

Type	RS232C User Communication	RS485 User Communication
Communication Port	Port 2 and Port 3	Port 2 and Port 3
Maximum Nodes	1 per port	31 maximum
Standards	EIA RS232C	EIA RS485
Baud Rate	1200, 2400, 4800, 9600, 19200, 38400, 57600, 115200 bps (Default: 115200)	
Data Bits	7 or 8 bits (Default: 7) (Note)	
Parity	Odd, Even, None (Default: Even) (Note)	
Stop Bits	1 or 2 bits (Default: 1)	
Receive Timeout	10 to 2540ms (10ms increments) or none (Receive timeout is disabled when 2550 ms is selected.) The receive timeout has an effect when using RXD instructions.	
Communication Method	Start-stop synchronization system	
Maximum Cable Length	3m	200m
Maximum Transmit Data	200 bytes	
Maximum Receive Data	200 bytes	
BCC Calculation	XOR, ADD, ADD-2comp *, Modbus ASCII *, Modbus RTU * (* For calculation examples, see "BCC Calculation Examples" on page 10-28.)	

Note: The following configuration cannot be selected: Data Bits: 7, Parity: None

10: USER COMMUNICATION INSTRUCTIONS

RS232C User Communication System Setup

To connect an RS232C communication device to port 2 or 3 on the SmartAXIS, use the user communication cable FC2A-KP1C. One end of the user communication cable is not provided with a connector, and can be terminated with a proper connector to plug in to communicate with the RS232C port.

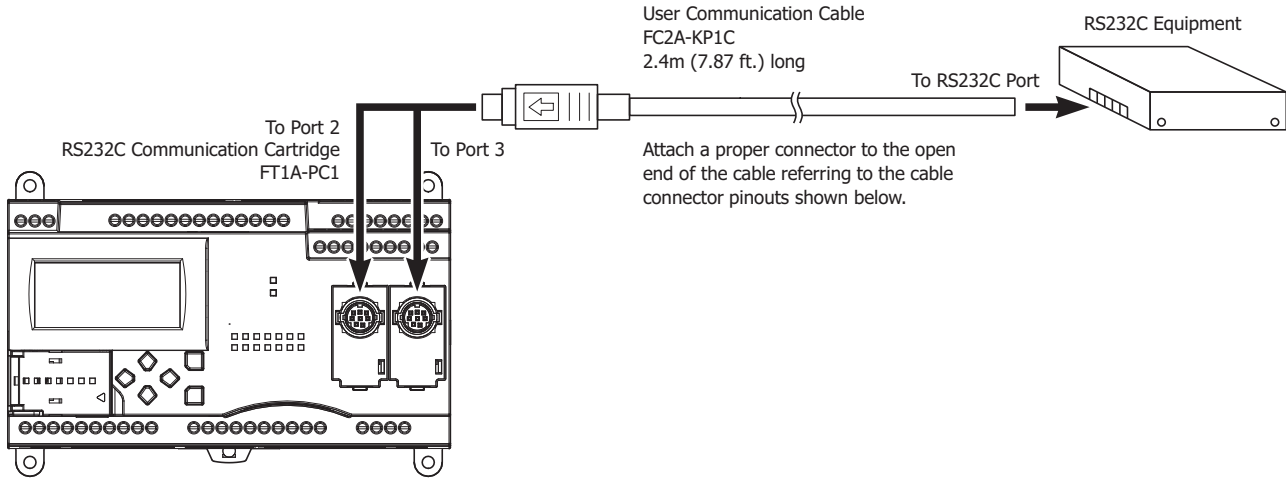

Cable Connector Pinouts

Pin	Port 2, Port 3	AWG#	Color	Signal Direction
1	RTS (request to send)	28	Black	
2	DTR (data terminal ready)	28	Yellow	
3	TXD (transmit data)	28	Blue	
4	RXD (receive data)	28	Green	
5	DSR (data set ready)	28	Brown	
6	SG (signal ground)	28	Gray	
7	SG (signal ground)	26	Red	
8	NC (no connection)	26	White	
Cover	—	—	Shield	

RS485 User Communication System Setup

Using the RS485 user communication, a maximum of 31 RS485 devices can be connected to the SmartAXIS.

When using port 2 or 3 for RS485 communication on the SmartAXIS, install the RS485 communication cartridge (FT1A-PC2 or FT1A-PC3) to the expansion communication port.

Connect RS485 device to the RS485 terminals A, B, and SG of port 2 or 3 on the SmartAXIS using a shielded twisted pair cable as shown below. When using the RS485 communication cartridge (FT1A-PC2) to the expansion communication port, use the user communication cable FC2A-KP1C. One end of the user communication cable is not provided with a connector, and can be terminated with a proper connector to plug in to communicate with the RS232C port.

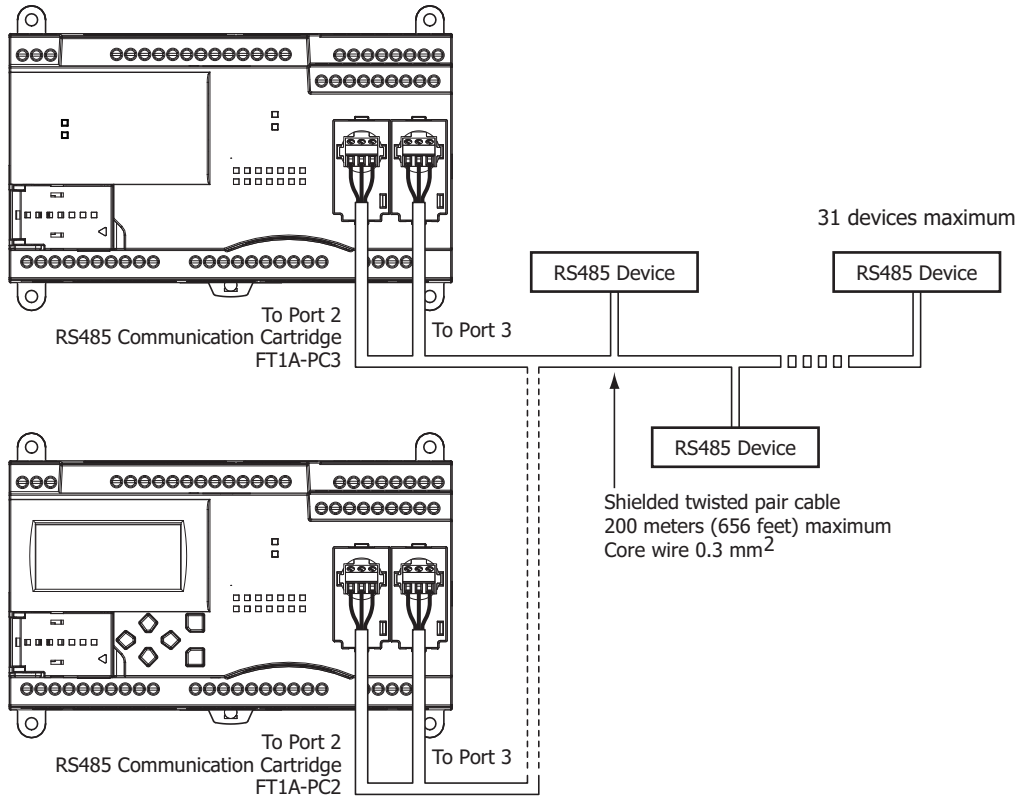

Cable Connector Pinouts

Pin	Port 2, Port 3	AWG#	Color	Signal Direction
1	B	28	Black	→
2	A	28	Yellow	→
3	NC (no connection)	28	Blue	→
4	NC (no connection)	28	Green	←
5	NC (no connection)	28	Brown	←
6	NC (no connection)	28	Gray	←
7	SG (signal ground)	26	Red	←
8	NC (no connection)	26	White	←
Cover	—	—	Shield	↕

Programming WindLDR

When using the user communication function to communicate with an external RS232C or RS485 device, set the communication parameters for the SmartAXIS to match those of the external device.

Note: Since communication parameters in the Function Area Settings relate to the user program, the user program must be downloaded to the SmartAXIS after changing any of these settings.

1. From the WindLDR menu bar, select **Configuration > Communication Ports**.

The Function Area Settings dialog box for Communication Ports appears.

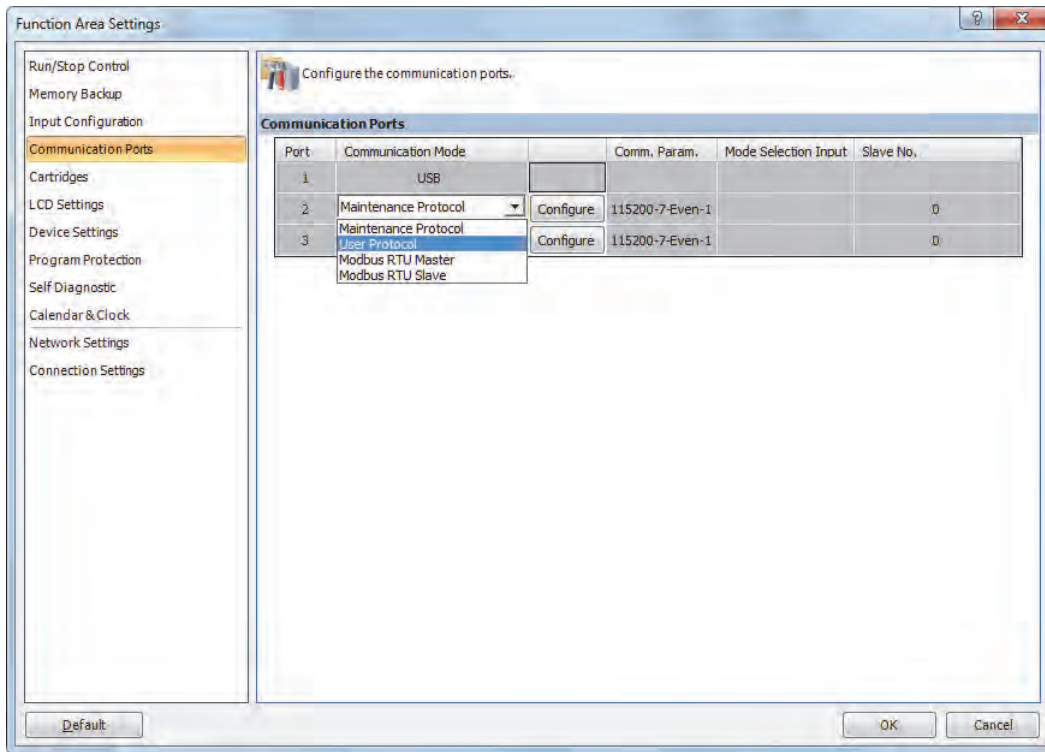

2. In the Communication Mode pull-down list for Port 2 and Port 3, select **User Protocol**. (Click the **Configure** button when changing previous settings.)

The User Protocol dialog box appears.

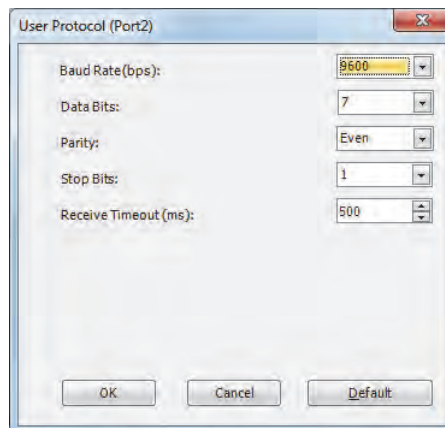

When **2550ms** is selected in the Receive Timeout box, the receive timeout function is disabled.

3. Select communication parameters to the same values for the device to communicate with.
4. Click the **OK** button.

Programming TXD Instruction Using WindLDR

The following example demonstrates how to program a TXD instruction including a start delimiter, BCC, and end delimiter using WindLDR.

TXD sample program:

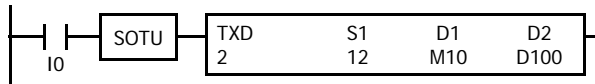

Communication port: Port 2
 Transmit completion output: M10
 Transmit status register: D100
 Transmit data byte count: D101

Data register contents:

D10 04D2h = 1234
 D11 162Eh = 5678

Transmit data example:

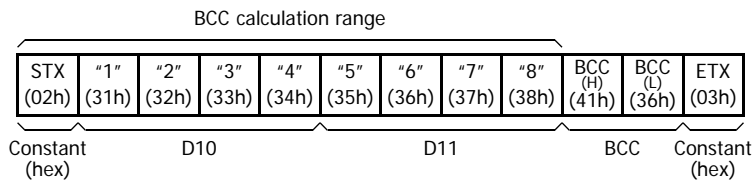

1. Start to program a TXD instruction. Move the cursor where you want to insert the TXD instruction, and type **TXD**. You can also insert the TXD instruction by clicking the User Communication icon in the menu bar and clicking where you want to insert the TXD instruction in the program edit area. The Transmit instruction dialog box appears.

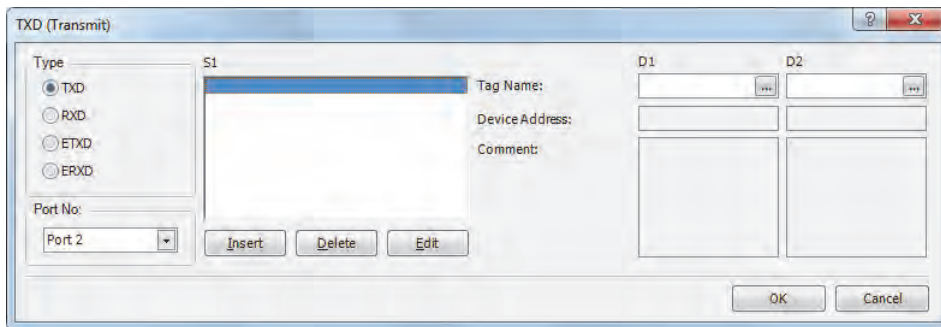

10: USER COMMUNICATION INSTRUCTIONS

2. Check that **TXD** is selected in the Type box and select **Port 2** in the Port box. Then, click **Insert**. The Data Type Selection dialog box appears. You will program source device S1 using this dialog box.
3. Click **Constant (Hexadecimal)** in the Type box and click **OK**. Next, in the Constant (Hexadecimal) dialog box, type **02** to program the start delimiter STX (02h). When finished, click **OK**.

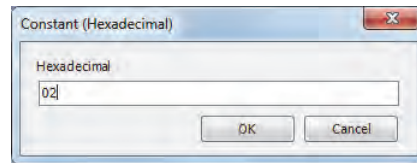
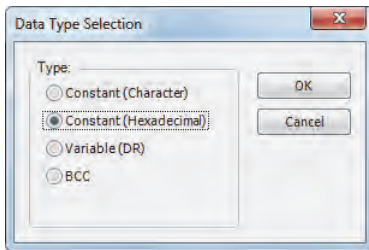

4. Since the Transmit instruction dialog box reappears, repeat the above procedure. In the Data Type Selection dialog box, click **Variable (DR)** and click **OK**. Next, in the Variable (Data Register) dialog box, type **D10** in the DR No. box and click **BCD to ASCII** to select the BCD to ASCII conversion. Enter **4** in the Digits box (4 digits) and **2** in the REP box (2 repeat cycles). When finished, click **OK**.

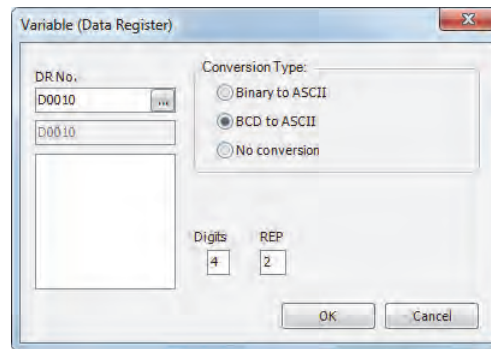
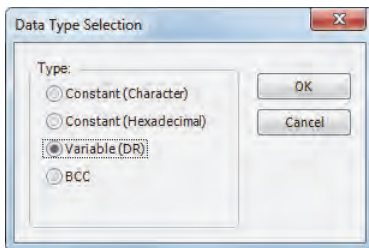

5. Again in the Data Type Selection dialog box, click **BCC** and click **OK**. Next, in the BCC dialog box, enter **1** in the Calculation Start Position box, select **ADD** for the Calculate Type, click **Binary to ASCII** for the Conversion Type, and click **2** for the Digits. When finished, click **OK**.

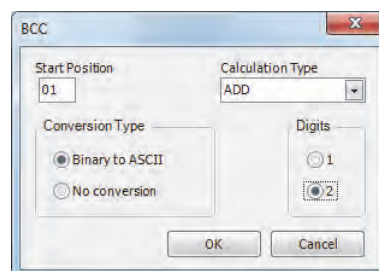
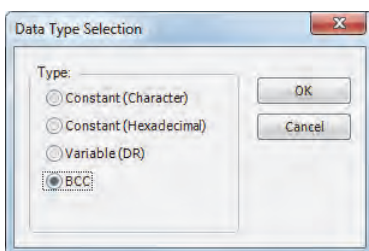

6. Once again in the Data Type Selection dialog box, click **Constant (Hexadecimal)** and click **OK**. Next, in the Constant (Hexadecimal) dialog box, type **03** to program the end delimiter ETX (03h). When finished, click **OK**.

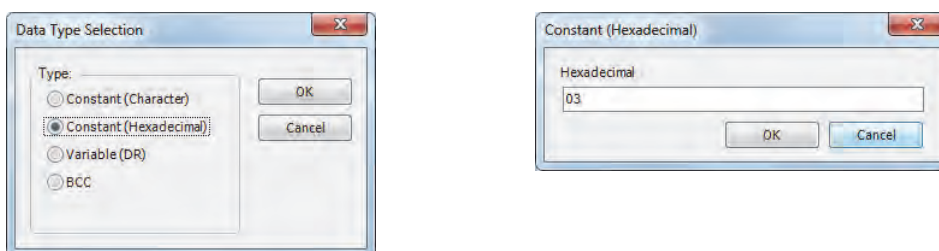

7. In the Transmit instruction dialog box, type **M10** in the destination D1 box and type **D100** in the destination D2 box. When finished, click **OK**.

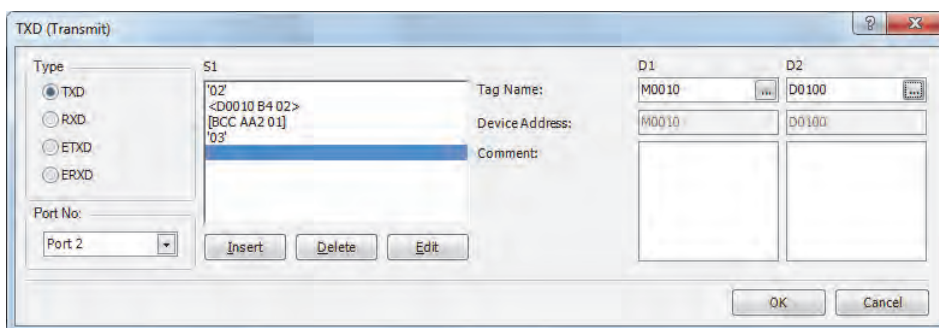

Programming of the TXD2 instruction is complete and the transmit data is specified as follows:

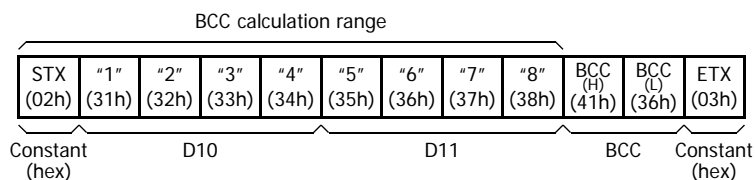

10: USER COMMUNICATION INSTRUCTIONS

Programming RXD Instruction Using WindLDR

The following example demonstrates how to program an RXD instruction including a start delimiter, skip, constant for verification, BCC, and end delimiter using WindLDR. Converted data is stored to data registers D10 and D11. Internal relay M100 is used as destination D1 for the receive completion output. Data register D1000 is used as destination D2 for the receive status, and data register D1001 is used to store the receive data byte count.

Receive data example:

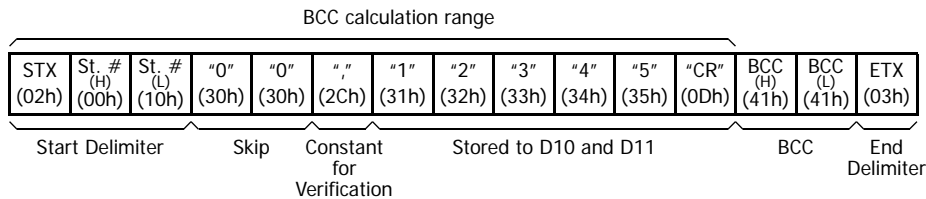

RXD sample program:

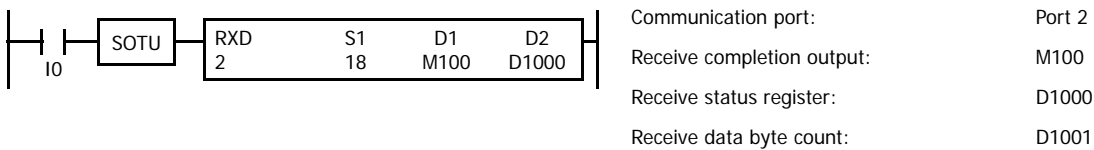

1. Start to program an RXD instruction. Move the cursor where you want to insert the RXD instruction, and type **RXD**. You can also insert the RXD instruction by clicking the User Communication icon in the menu bar and clicking where you want to insert the RXD instruction in the program edit area, then the Transmit dialog box appears. Click **RXD** to change the dialog box to the Receive dialog box.

The Receive instruction dialog box appears.

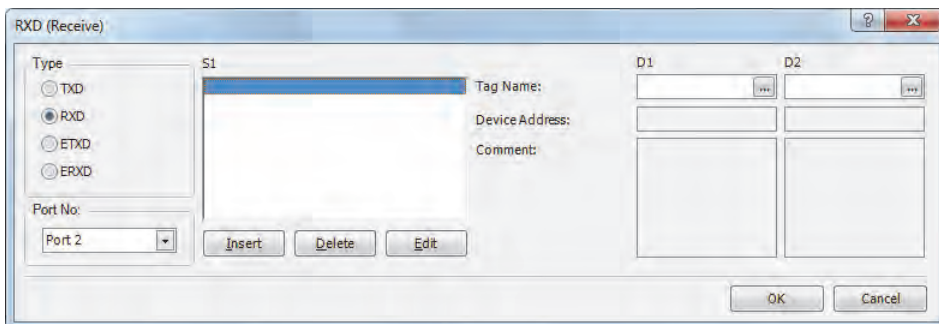

2. Check that **RXD** is selected in the Type box and select **Port 2** in the Port box. Then, click **Insert**. The Data Type Selection dialog box appears. You will program source device S1 using this dialog box.
3. Click **Constant (Hexadecimal)** in the Type box and click **OK**. Next, in the Constant (Hexadecimal) dialog box, type **020010** to program the start delimiter STX (02h), Station No. H (00h), and Station No. L (10h). When finished, click **OK**.

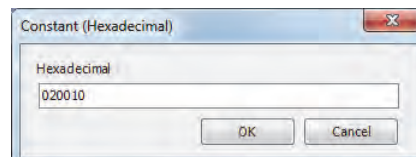
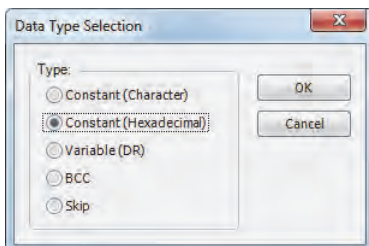

- Since the Receive instruction dialog box reappears, repeat the above procedure. In the Data Type Selection dialog box, click **Skip** and click **OK**. Next, in the Skip dialog box, type **02** in the Digits box and click **OK**.

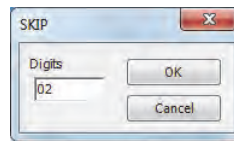
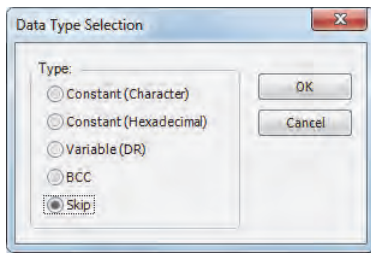

- Again in the Data Type Selection dialog box, click **Constant (Character)** and click **OK**. Next, in the Constant (Character) dialog box, type **,** (**2Ch**) in the Character box to program a comma as a constant to verify. When finished, click **OK**.

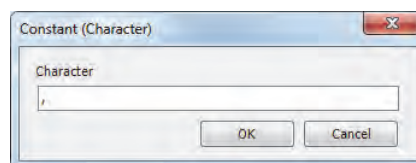
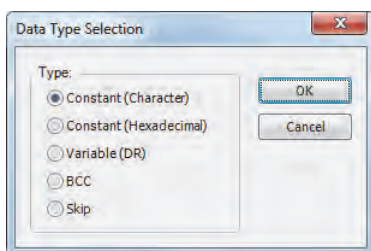

- Again in the Data Type Selection dialog box, click **Variable (DR)** and click **OK**. Next, in the Variable (Data Register) dialog box, type **D10** in the DR No. box and click **ASCII to Binary** to select ASCII to binary conversion. Enter **4** in the Digits box (4 digits) and **2** in the REP box (2 repeat cycles). Click **Variable**, select **HEX**, and type **0D** to designate a delimiter. When finished, click **OK**.

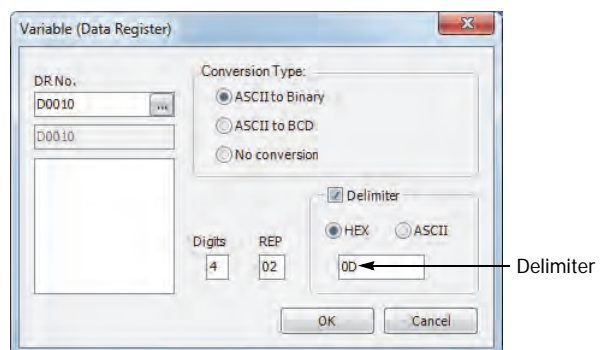
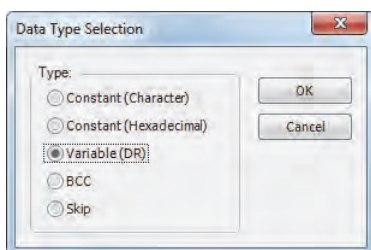

- Again in the Data Type Selection dialog box, click **BCC** and click **OK**. Next, in the BCC dialog box, enter **1** in the Calculation Start Position box, select **ADD** for the Calculation Type, click **Binary to ASCII** for the Conversion Type, and click **2** for the Digits. When finished, click **OK**.

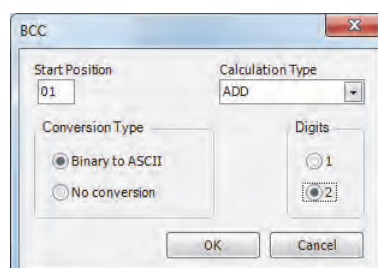
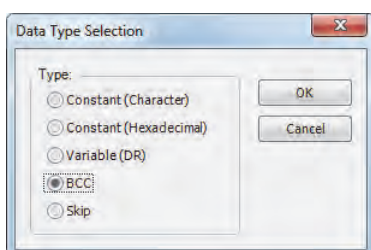

10: USER COMMUNICATION INSTRUCTIONS

8. Once again in the Data Type Selection dialog box, click **Constant (Hexadecimal)** and click **OK**. Next, in the Constant (Hexadecimal) dialog box, type **03** to program the end delimiter ETX (03h). When finished, click **OK**.

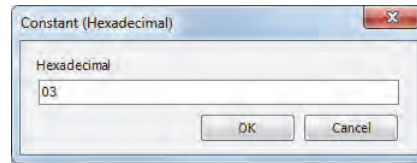
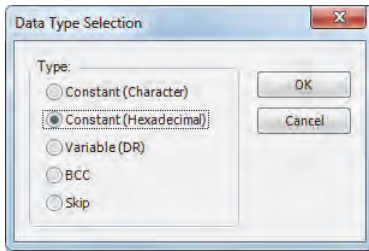

9. In the Receive instruction dialog box, type **M100** in the destination D1 box and type **D1000** in the destination D2 box. When finished, click **OK**.

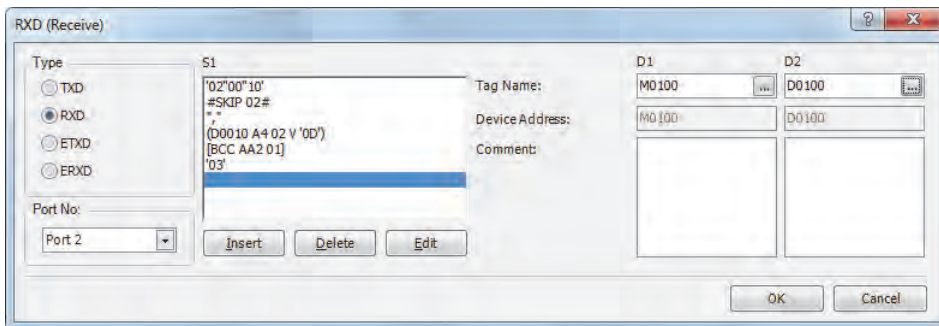

Programming of the RXD instruction is complete and the receive data will be stored as follows:

D10

1234h

 = 4660
D11

0005h

 = 5

RS232C Line Control Signals

While the SmartAXIS is in user communication mode, special data registers can be used to enable or disable DSR and DTR control signal options for port 2 through port 3. The DSR and DTR control signal options cannot be used for port 1.

The RTS signal line of port 2 through port 3 remains on.

In the maintenance communication mode, DSR has no effect and DTR remains on.

Special Data Registers for Port 2 to Port 3 RS232C Line Control Signals

Special data registers D8104 through D8106 are allocated for RS232C line control signals.

Communication Port	DR No.	Data Register Function	Data Register Value Updated	R/W
Port 2 to Port 3	D8104	Control signal status	Every scan	R
	D8105	DSR input control signal option	When sending/receiving data	R/W
	D8106	DTR output control signal option	When sending/receiving data	R/W

Control Signal Status D8104

Special data register D8104 stores a value to show that DSR and DTR are on or off at port 2 through port 3.

The data of D8104 is updated at every END processing.

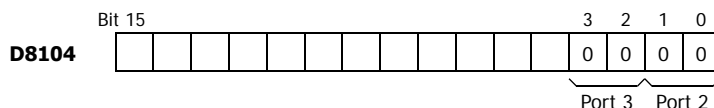

D8104 2-bit Binary Value	DTR	DSR	Description
00	OFF	OFF	Both DSR and DTR are off
01	OFF	ON	DSR is on
10	ON	OFF	DTR is on
11	ON	ON	Both DSR and DTR are on

DSR Control Signal Status in RUN and STOP Modes

Communication Mode	D8105 3-bit Binary Value	DSR (Input) Status	
		RUN Mode	STOP Mode
User Communication Mode	000 (default)	No effect	No effect (TXD/RXD disabled)
	001	ON: Enable TXD/RXD OFF: Disable TXD/RXD	No effect (TXD/RXD disabled)
	010	ON: Disable TXD/RXD OFF: Enable TXD/RXD	No effect (TXD/RXD disabled)
	011	ON: Enable TXD OFF: Disable TXD	No effect (TXD/RXD disabled)
	100	ON: Disable TXD OFF: Enable TXD	No effect (TXD/RXD disabled)
	≥ 101	No effect	No effect (TXD/RXD disabled)
Maintenance Mode	—	No effect	No effect

DTR Control Signal Status in RUN and STOP Modes

Communication Mode	D8106 2-bit Binary Value	DTR (Output) Status	
		RUN Mode	STOP Mode
User Communication Mode	00 (default)	ON	OFF
	01	OFF	OFF
	10	RXD enabled: ON RXD disabled: OFF	OFF
	11	ON	OFF
Maintenance Mode	—	ON	ON

10: USER COMMUNICATION INSTRUCTIONS

DSR Input Control Signal Option D8105

Special data register D8105 is used to control data flow between the SmartAXIS RS232C port 2 through port 3 and the remote terminal depending on the DSR (data set ready) signal sent from the remote terminal. The DSR signal is an input to the SmartAXIS to determine the status of the remote terminal. The remote terminal informs the SmartAXIS using DSR whether the remote terminal is ready for receiving data or is sending valid data.

The DSR control signal option can be used only for the user communication through the RS232C port 2 to port 3.

The control status of each port is allocated as shown below:

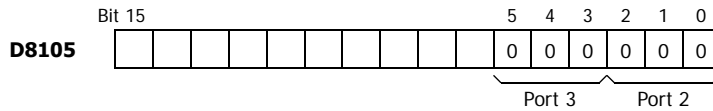

D8105 3-bit Binary Value	Description
000	DSR is not used for data flow control. When DSR control is not needed, set 0 to D8105.
001	When DSR is on, the SmartAXIS can transmit and receive data.
010	When DSR is off, the SmartAXIS can transmit and receive data.
011	When DSR is on, the SmartAXIS can transmit data. This function is usually called "Busy Control" and is used for controlling transmission to a remote terminal with a slow processing speed, such as a printer. When the remote terminal is busy, data input to the remote terminal is restricted.
100	When DSR is off, the SmartAXIS can transmit data.
≥ 101	Same as D8105 = 000. DSR is not used for data flow control.

DTR Output Control Signal Option D8106

Special data register D8106 is used to control the DTR (data terminal ready) signal to indicate the SmartAXIS operating status or transmitting/receiving status.

The DTR control signal option can be used only for the user communication through the RS232C port 2 to port 3.

The control status of each port is allocated as shown below:

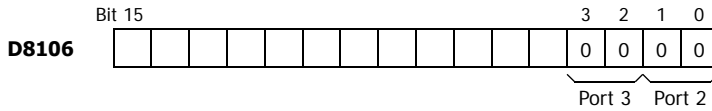

D8106 2-bit Binary Value	Description								
00	<p>While the SmartAXIS is running, DTR is on whether the SmartAXIS is transmitting or receiving data. While the SmartAXIS is stopped, DTR remains off. Use this option to indicate the SmartAXIS operating status.</p> <table border="1" data-bbox="528 763 1382 875"> <tr> <td>SmartAXIS</td> <td>Stopped</td> <td>Running</td> <td>Stopped</td> </tr> <tr> <td>DTR signal</td> <td>OFF</td> <td>ON</td> <td>OFF</td> </tr> </table>	SmartAXIS	Stopped	Running	Stopped	DTR signal	OFF	ON	OFF
SmartAXIS	Stopped	Running	Stopped						
DTR signal	OFF	ON	OFF						
01	<p>Whether the SmartAXIS is running or stopped, DTR remains off.</p> <table border="1" data-bbox="528 965 1382 1077"> <tr> <td>SmartAXIS</td> <td>Stopped</td> <td>Running</td> <td>Stopped</td> </tr> <tr> <td>DTR signal</td> <td>OFF</td> <td>OFF</td> <td>OFF</td> </tr> </table>	SmartAXIS	Stopped	Running	Stopped	DTR signal	OFF	OFF	OFF
SmartAXIS	Stopped	Running	Stopped						
DTR signal	OFF	OFF	OFF						
10	<p>While the SmartAXIS can receive data, DTR is turned on. While the SmartAXIS can not receive data, DTR remains off. Use this option when flow control of receive data is required.</p> <table border="1" data-bbox="528 1189 1382 1301"> <tr> <td>Receive</td> <td>Impossible</td> <td>Possible</td> <td>Impossible</td> </tr> <tr> <td>DTR signal</td> <td>OFF</td> <td>ON</td> <td>OFF</td> </tr> </table>	Receive	Impossible	Possible	Impossible	DTR signal	OFF	ON	OFF
Receive	Impossible	Possible	Impossible						
DTR signal	OFF	ON	OFF						
11	Same as D8106 = 00.								

User Communication via Ethernet Communication

This section describes the Ethernet user communication. Ethernet user communication works on TCP/IP protocol. The SmartAXIS can be used as a user communication client/server. With Ethernet user communication instructions (ETXD and ERXD instructions), the SmartAXIS can exchange the data with devices on the network.

Except for the port number and the allocation of the user communication receive instruction cancel flags, Ethernet user communication instructions (ETXD and ERXD instructions) are identical to TXD and RXD instructions. For details about TXD and RXD instructions, see Chapter 25 "User Communication Instructions" in the SmartAXIS Ladder Programming Manual.

Ethernet User Communication Overview

The SmartAXIS can be used as an Ethernet user communication client/server. It can be used simultaneously with the maintenance communication server, Modbus TCP server, and Modbus TCP client.

When using the SmartAXIS user communication client, the SmartAXIS can access and communicate with the server devices using the protocol of the server device. A maximum of three client connections of the SmartAXIS can be allocated to user communication.

User communication client functions and configuration are described in "To use the SmartAXIS as a user communication client" on page 10-15. User communication server functions and configuration are described in "User Communication Server" on page 10-19. The SmartAXIS supports the TCP/IP protocol.

The SmartAXIS can send data to and receive data from devices on a network by using the ETXD (Ethernet user communication transmit) instruction and the ERXD (Ethernet user communication receive) instruction.

The SmartAXIS can be used as both an Ethernet user communication client and server.

Each of the three connections possessed by the SmartAXIS can be allocated to different types of communication. Ethernet user communication can simultaneously use the maintenance communication server, Modbus TCP server, and Modbus TCP client.

[Ethernet communication example using three connections]

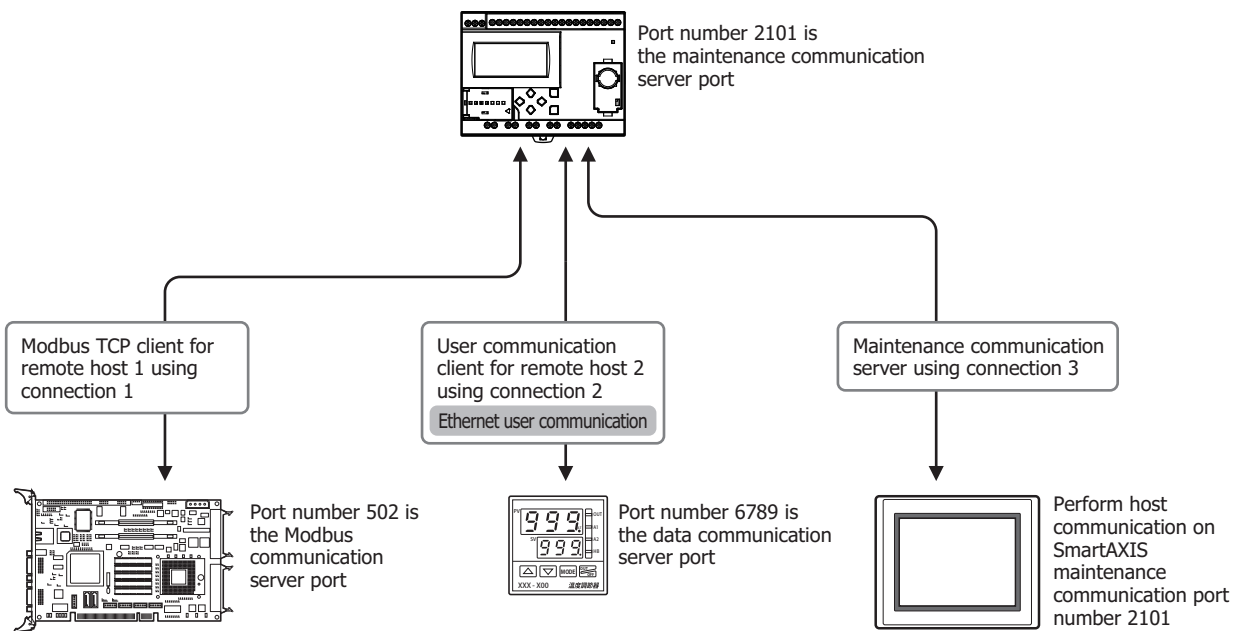

SmartAXIS function area settings connection settings

Connection	Communication protocol	Other settings
1	Modbus TCP client	Destination: Remote host 1
2	User communication client	Destination: Remote host 2
3	Maintenance communication server	Port number: 2101

Remote host table

Remote host number	IP address	Port number
1	192.168.0.12	502
2	192.168.0.13	6789

To use the SmartAXIS as a user communication client

Connect the SmartAXIS to the server device via the network and communicate with the server device using the Ethernet user communication instructions.

A maximum of three connections can be allocated to user communication clients. The SmartAXIS can simultaneously connect to and communicate with three different server devices.

[When three connections are allocated to user communication client]

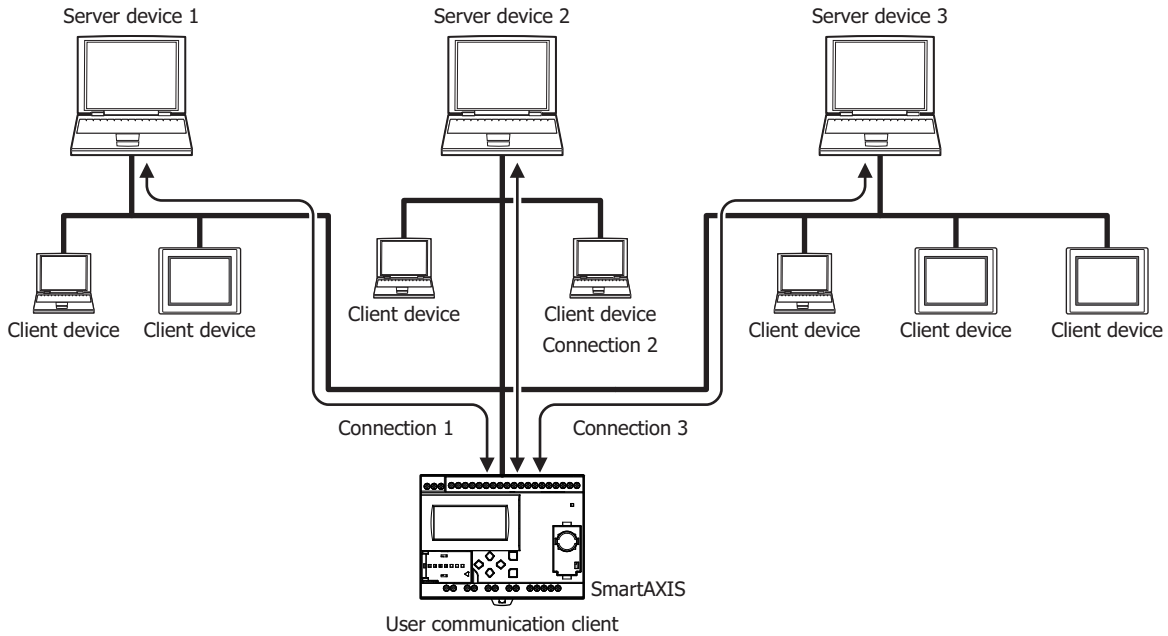

To use the SmartAXIS as a user communication server

The client devices connect to the SmartAXIS and the SmartAXIS communicates with the client devices using Ethernet user communication instructions.

A maximum of three connections can be allocated to user communication servers. A maximum of three client devices can simultaneously connect to and communicate with the SmartAXIS.

[When three connections are allocated to user communication server]

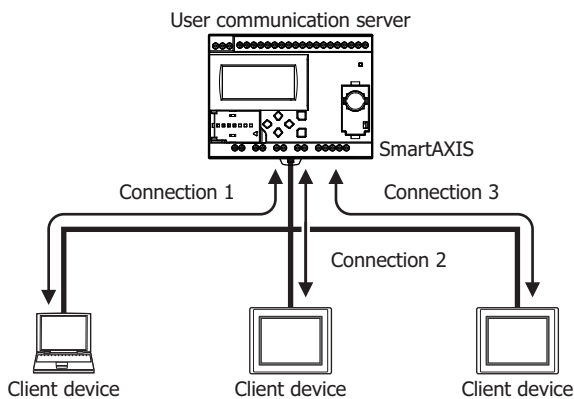

10: USER COMMUNICATION INSTRUCTIONS

User Communication Client

When a client connection is configured as the user communication client, the SmartAXIS communicates with the specified server device according to the settings configured in the ETXD and ERXD instructions that are programmed for the client connection. The remote host number and other communication settings can be configured in the Connection Settings tab in the Function Area Settings dialog box.

Specifications (User Communication Client)

Item	User Communication Client
Remote host number	1 to 255
Establish connection	<ul style="list-style-type: none"> When ETXD/ERXD Instructions are executed When the SmartAXIS starts to run (Note 1)
Disconnect connection	<ul style="list-style-type: none"> When the SmartAXIS is stopped When special internal relays (M8130 to M8132) are turned on
Number of remote hosts that the SmartAXIS can communicate simultaneously	One remote host per a user communication client (Note 2)
Receive timeout	100 to 25400 ms (100 ms increments); Default: 1000 ms (Note 3)

Note 1: Can be enabled or disabled in Function Area Settings, Connection Settings.

Note 2: The settings can be configured in the Connection Settings tab in the Function Area Settings dialog box.

Note 3: The receive timeout is enabled when using the ERXD instruction. To disable the receive timeout, set it to 25500 ms.

Establishing/Disconnecting User Communication Client Connections

When user communication clients are configured, connections are established on TCP/IP protocol. The connections are established when ETXD/ERXD instructions are executed or when the SmartAXIS has started to run (See Note 1 above). After a connection has been established, the connection will be kept open until either the SmartAXIS is stopped or a special internal relay allocated to the connection is turned on.

Device Address	Description	Operation
M8130	Connection 1 Disconnect	When the reply is turned on, the corresponding connection is disconnected.
M8131	Connection 2 Disconnect	
M8132	Connection 3 Disconnect	

User Communication Client Receive Instruction (ERXD) Cancel Flag

The allocation of the user communication receive instruction cancel flags for each client connection is shown in the table below. For details about the user communication receive instruction cancel flag, see Chapter 25 "User Communication Instructions" in the SmartAXIS Ladder Programming Manual.

Device Address	Description
M8100	User Communication Receive Instruction Cancel Flag (Connection 1)
M8101	User Communication Receive Instruction Cancel Flag (Connection 2)
M8102	User Communication Receive Instruction Cancel Flag (Connection 3)

Programming WindLDR (User Communication Client)

To use the user communication client, configure the user client communication settings in the Function Area Settings dialog box and then download the user program to the SmartAXIS.

1. Select **Configuration** from the WindLDR menu bar, and then click **Connection Settings**.
The Function Area settings dialog box appears.
2. Select the **User Communication Client** as the communication mode for the client connection 1.

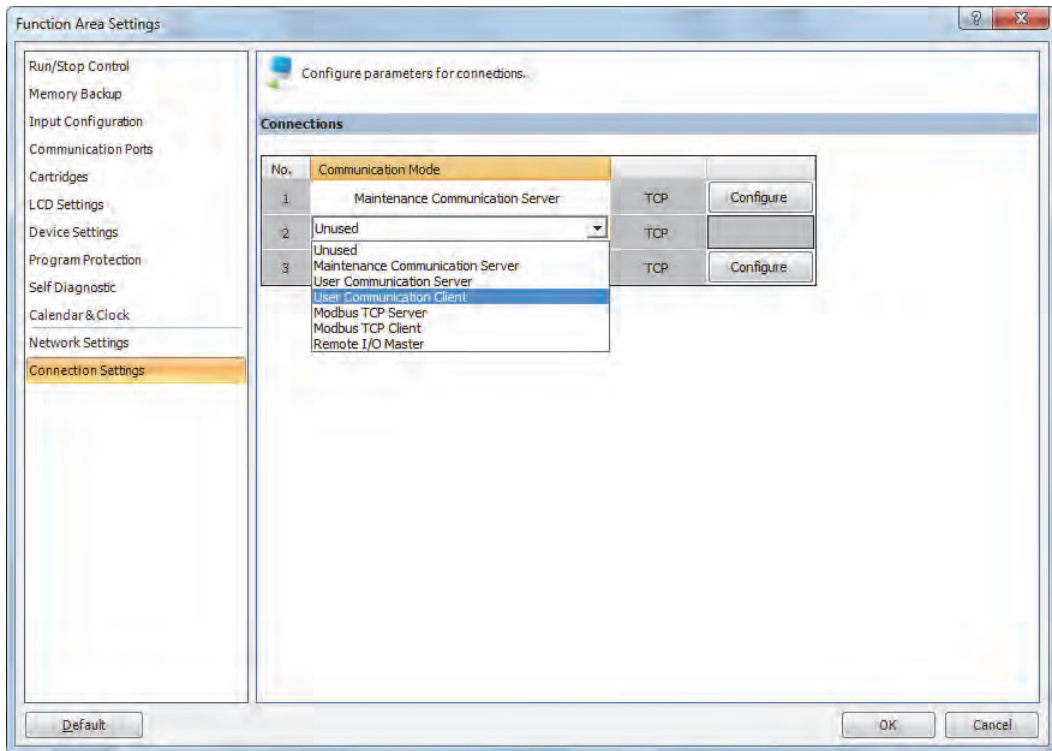

The User Communication Client dialog box appears.

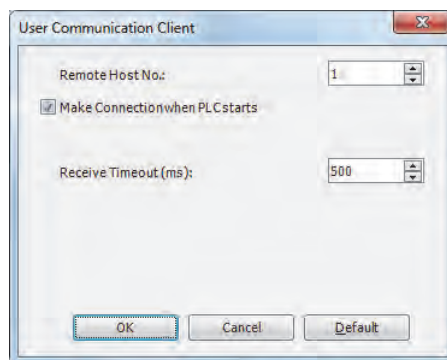

Configure the remote host number and receive timeout. If you want the SmartAXIS to establish the connection when it starts to run, select "Make Connection when PLC starts." Click **OK** button to close the dialog box.

10: USER COMMUNICATION INSTRUCTIONS

3. Edit the user program.

To insert Ethernet user communication instructions to the ladder editor, select the Ethernet user communication instructions (ETXD or ERXD instructions) in the Coil Selection dialog box.

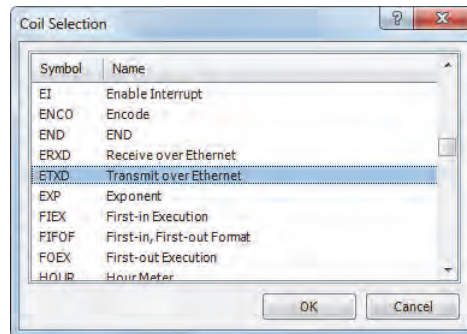

The Ethernet User Communication Instruction dialog box appears.

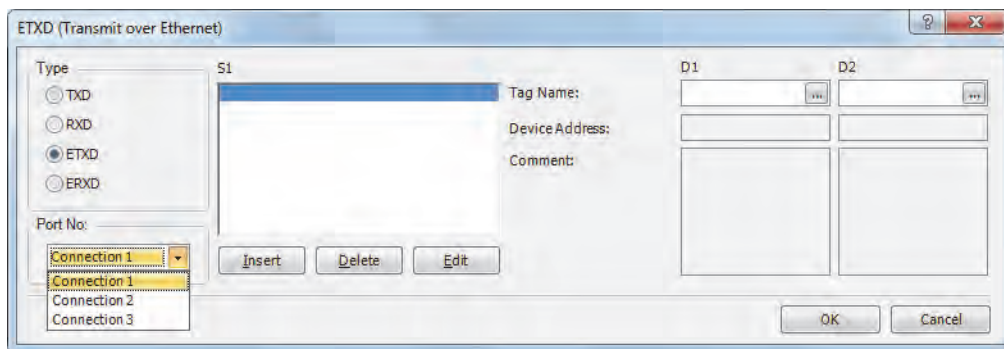

Select ETXD (Transmit over Ethernet) to transmit data or ERXD (Receive over Ethernet) to receive data as the instruction type. Select the client connection from 1 through 3 and designate S1, D1, and D2. Click **OK** button to close the dialog box.

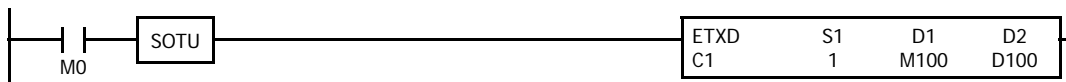

4. Download the user program.

The settings for the user communication client have been finished.

The specifications of Ethernet user communication instructions (ETXD and ERXD instructions) are identical to TXD and RXD instructions. For details about TXD and RXD instructions, see Chapter 25 "User Communication Instructions" in the SmartAXIS Ladder Programming Manual.

User Communication Server

When a server connection is configured as the user communication server, a client device can access and communicate with the SmartAXIS. The SmartAXIS communicates with the client device according to the settings configured in the ETXD and ERXD instructions that are programmed for the server connection. The local host number and other communication settings can be configured in the **Connection Settings** tab in the Function Area Settings dialog box.

Specifications (User Communication Server)

Item	User Communication Server
Local host port number	2102 to 2104 (Can be changed between 0 and 65535)
Number of clients that can simultaneously communicate with the SmartAXIS	One client per a user communication server (Note 1)
Receive timeout	100 to 25400 ms (100 ms increments) (Note 2)

Note 1: A maximum of three connections can be allocated to user communication servers, and a maximum of three client devices can simultaneously connect to and communicate with the SmartAXIS.

Note 2: The receive timeout is enabled when using the ERXD instruction. To disable the receive timeout, set it to 25500 ms.

User Communication Server Receive Instruction (ERXD) Cancel Flag

The allocation of the user communication receive instruction cancel flags for each server connection is shown in the table below. For details about the user communication receive instruction cancel flag, see Chapter 25 "User Communication Instructions" in the SmartAXIS Ladder Programming Manual.

Device Address	Description
M8100	User Communication Receive Instruction Cancel Flag (Connection 1)
M8101	User Communication Receive Instruction Cancel Flag (Connection 2)
M8102	User Communication Receive Instruction Cancel Flag (Connection 3)

Programming WindLDR (User Communication Server)

To use the user communication server, configure the user communication server settings in the Function Area Settings dialog box and then download the user program to the SmartAXIS.

1. Select **Configuration** from the WindLDR menu bar, and then click **Connection Settings**.
The Function Area settings dialog box appears.
2. Select the **User Communication Server** as the communication mode for the server connection 1.

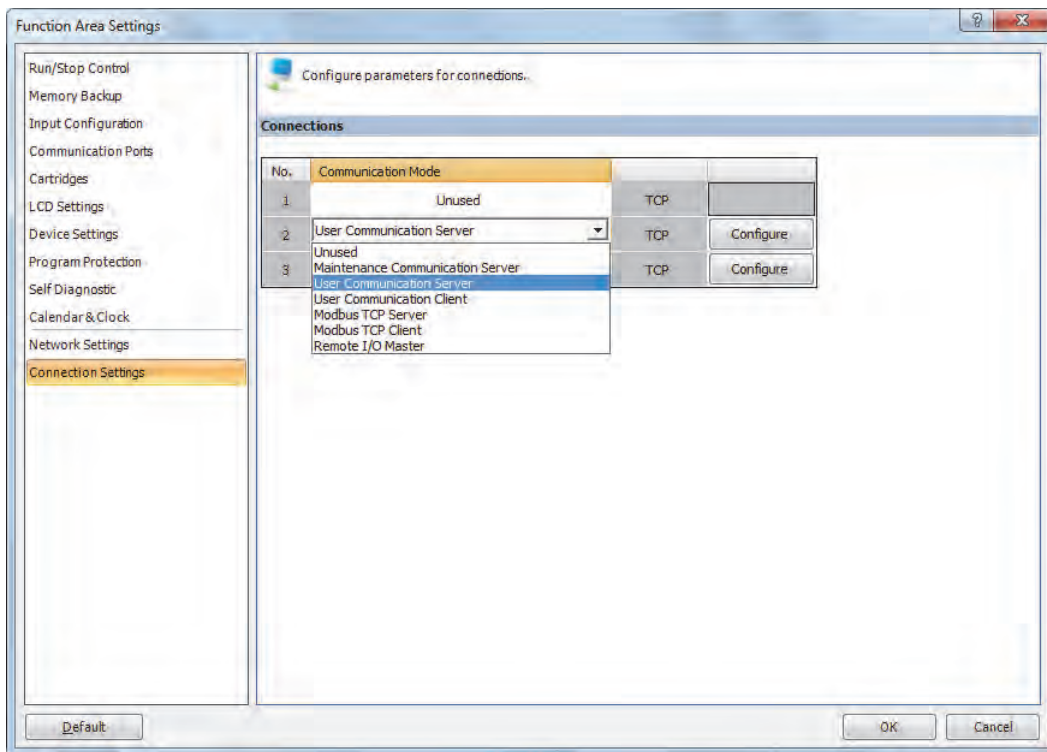

The User Communication Server dialog box appears.

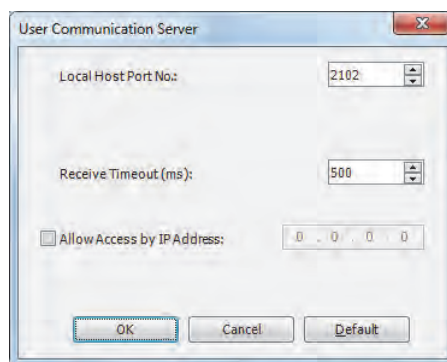

Configure the local host port number and receive timeout. If you want to restrict the access using IP address, configure the allowed IP address.

3. Edit the user program.

To insert Ethernet user communication instructions to the ladder editor, select the Ethernet user communication instructions (ETXD or ERXD instructions) in the Coil Selection dialog box.

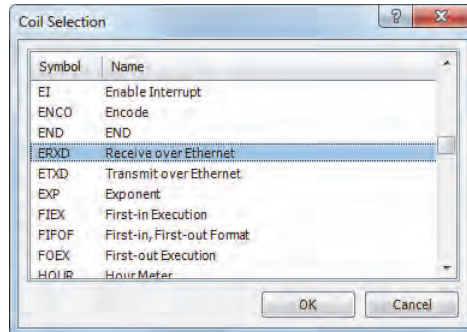

The Ethernet User Communication Instruction dialog box appears.

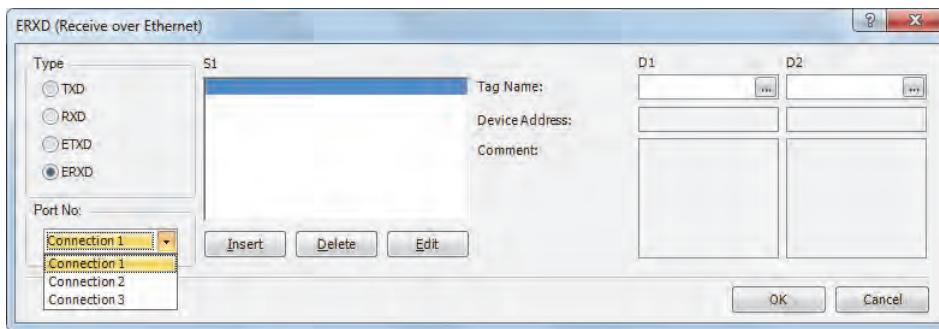

Select **ETXD** (Transmit over Ethernet) to transmit data and **ERXD** (Receive over Ethernet) to receive data as the instruction type. Select the server connection from 1 through 8 and designate S1, D1, and D2. Click **OK** button to close the dialog box.

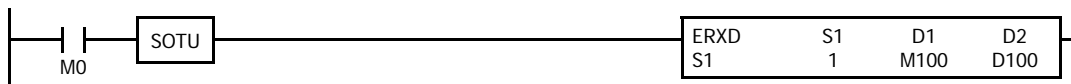

4. Download the user program.

The settings for the user communication server have been finished.

The specifications of Ethernet user communication instructions (ETXD and ERXD instructions) are identical to TXD and RXD instructions. For details about TXD and RXD instructions, see Chapter 25 "User Communication Instructions" in the SmartAXIS Ladder Programming Manual.

10: USER COMMUNICATION INSTRUCTIONS

User Communication Error

When a user communication error occurs, an error code is stored in the data register designated as a transmit status in the TXD instruction or as a receive status in the RXD instruction. When multiple errors occur, the final error code overwrites all preceding errors and is stored in the status data register.

The status data register also contains transmit/receive status code. To extract a user communication error code from the status data register, divide the value by 16. The remainder is the user communication error code. See Chapter 25 "User Communication Instructions" in the SmartAXIS Ladder Programming Manual.

To correct the error, correct the user program by referring to the error causes described below:

User Communication Error Code

User Communication Error Code	Error Cause	Transmit/Receive Completion Output
1	Start inputs to more than 5 TXD instructions are on simultaneously.	Transmit completion outputs of the first 5 TXD instructions from the top of the ladder diagram are turned on.
2	Transmission destination busy timeout	The transmit completion output goes on.
3	Start inputs to more than 5 RXD instructions with a start delimiter are on simultaneously.	Among the first 5 RXD instructions from the top of the ladder diagram, receive completion outputs of RXD instructions go on if the start delimiter matches the first byte of the received data.
4	While a RXD instruction without a start delimiter is executed, another RXD instruction with or without a start delimiter is executed.	The receive completion output of the RXD instruction at a smaller address goes on.
5	While a RXD instruction with a start delimiter is executed, another RXD instruction with the same start delimiter is executed.	No effect on the receive completion output.
7	The first bytes of received data do not match the specified start delimiter.	No effect on the receive completion output. If incoming data with a matching start delimiter is received subsequently, the receive completion output goes on.
8	When ASCII to binary or ASCII to BCD conversion is specified in the receive format, any code other than 0 to 9 and A to F is received. (These codes are regarded as 0 during conversion.)	The receive completion output goes on.
9	BCC calculated from the RXD instruction does not match the BCC appended to the received data.	The receive completion output goes on.
10	Constants including the end delimiter code specified in the RXD instruction do not match the received constants.	The receive completion output goes on.
11	Receive timeout between characters (After receiving one byte of data, the next byte is not received in the period specified for the receive timeout value.)	The receive completion output goes on.
12	Overrun error (Before the receive processing is completed, the next data is received.)	The receive completion output goes off.
13	Framing error (Detection error of start bit or stop bit)	No effect on the completion output.
14	Parity check error (Error is found in the parity check.)	No effect on the completion output.
15	A user communication instruction was used even though the port settings or the connection settings were not set to user communication mode.	No effect on the completion output.

ASCII Character Code Table

Upper Bit Lower Bit	0	1	2	3	4	5	6	7	8	9	A	B	C	D	E	F
0	NUL	DLE	SP	0	@	P	`	p								
Decimal	0	16	32	48	64	80	96	112	128	144	160	176	192	208	224	240
1	SOH	DC1	!	1	A	Q	a	q								
Decimal	1	17	33	49	65	81	97	113	129	145	161	177	193	209	225	241
2	STX	DC2	"	2	B	R	b	r								
Decimal	2	18	34	50	66	82	98	114	130	146	162	178	194	210	226	242
3	ETX	DC3	#	3	C	S	c	s								
Decimal	3	19	35	51	67	83	99	115	131	147	163	179	195	211	227	243
4	EOT	DC4	\$	4	D	T	d	t								
Decimal	4	20	36	52	68	84	100	116	132	148	164	180	196	212	228	244
5	ENQ	NAK	%	5	E	U	e	u								
Decimal	5	21	37	53	69	85	101	117	133	149	165	181	197	213	229	245
6	ACK	SYN	&	6	F	V	f	v								
Decimal	6	22	38	54	70	86	102	118	134	150	166	182	198	214	230	246
7	BEL	ETB	'	7	G	W	g	w								
Decimal	7	23	39	55	71	87	103	119	135	151	167	183	199	215	231	247
8	BS	CAN	(8	H	X	h	x								
Decimal	8	24	40	56	72	88	104	120	136	152	168	184	200	216	232	248
9	HT	EM)	9	I	Y	i	y								
Decimal	9	25	41	57	73	89	105	121	137	153	169	185	201	217	233	249
A	LF	SUB	*	:	J	Z	j	z								
Decimal	10	26	42	58	74	90	106	122	138	154	170	186	202	218	234	250
B	VT	ESC	+	;	K	[k	{								
Decimal	11	27	43	59	75	91	107	123	139	155	171	187	203	219	235	251
C	FF	FS	,	<	L	?	l									
Decimal	12	28	44	60	76	92	108	124	140	156	172	188	204	220	236	252
D	CR	GS	-	=	M]	m	}								
Decimal	13	29	45	61	77	93	109	125	141	157	173	189	205	221	237	253
E	SO	RS	.	>	N	^	n	~								
Decimal	14	30	46	62	78	94	110	126	142	158	174	190	206	222	238	254
F	SI	US	/	?	O	_	o									
Decimal	15	31	47	63	79	95	111	127	143	159	175	191	207	223	239	255

Sample Program – User Communication TXD

This example demonstrates a program to send data to a printer using the user communication TXD2 (transmit) instruction, with the optional RS232C communication cartridge installed on the port 2 connector of the 24-I/O type SmartAXIS.

System Setup

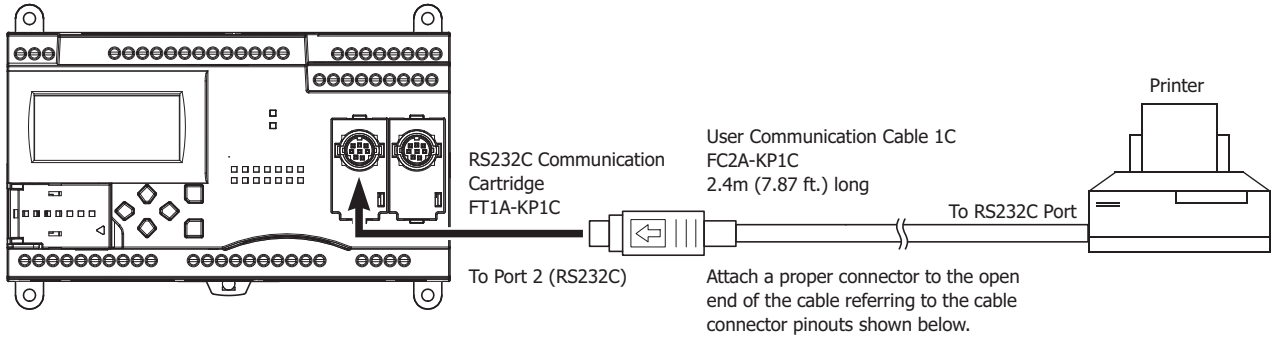

Cable Connection and Pinouts

Mini DIN Connector Pinouts

Description	Color	Pin
Shield	—	Cover
NC No Connection	Black	1
NC No Connection	Yellow	2
TXD Transmit Data	Blue	3
NC No Connection	Green	4
DSR Data Set Ready	Brown	5
NC No Connection	Gray	6
SG Signal Ground	Red	7
NC No Connection	White	8

D-sub 9-pin Connector Pinouts

Pin	Description
1	NC No Connection
2	NC No Connection
3	DATA Receive Data
4	NC No Connection
5	GND Ground
6	NC No Connection
7	NC No Connection
8	BUSY Busy Signal
9	NC No Connection

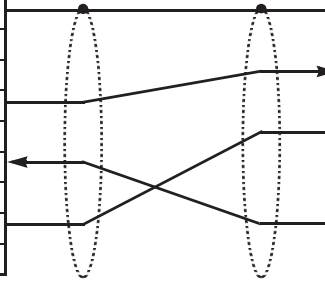

The name of BUSY terminal differs depending on printers, such as DTR. The function of this terminal is to send a signal to remote equipment whether the printer is ready to print data or not. Since the operation of this signal may differ depending on printers, confirm the operation before connecting the cable.

	Caution	<ul style="list-style-type: none"> Do not connect any wiring to the NC (no connection) pins; otherwise, the SmartAXIS and the printer may not work correctly and may be damaged.
--	----------------	---

Description of Operation

The data of counter C2 and data register D30 are printed every minute. A printout example is shown on the right.

Programming Special Data Register

Special data register D8105 is used to monitor the BUSY signal and to control the transmission of print data.

Special DR	Value	Description
D8105	3 (011)	While DSR is on (not busy), the SmartAXIS sends data. While DSR is off (busy), the SmartAXIS stops data transmission. If the off duration exceeds a limit (approx. 5 sec), a transmission busy timeout error will occur, and the remaining data is not sent. The transmit status data register stores an error code 2.

Printout Example

```

--- PRINT TEST ---

11H 00M

CNT2...0050
D030...3854

--- PRINT TEST ---

11H 01M

CNT2...0110
D030...2124
    
```

The SmartAXIS monitors the DSR signal to prevent the receive buffer of the printer from overflowing. For the DSR signal, see "DSR Input Control Signal Option D8105" on page 10-12.

Setting User Communication Mode in WindLDR Function Area Settings

Since this example uses the RS232C port 2, select User Protocol for Port 2 in the Function Area Settings using WindLDR. See "Programming WindLDR" on page 10-4.

Setting Communication Parameters

Set the communication parameters to match those of the printer. See "Programming WindLDR" on page 10-4. For details of the communication parameters of the printer, see the user's manual for the printer. An example is shown below:

Communication Parameters:

Baud rate: 9600 bps
 Data bits: 8
 Parity check: None
 Stop bits: 1

Note: The receive timeout value is used for the RXD instruction in the user communication mode. Since this example uses only the TXD instruction, the receive timeout value has no effect.

Ladder Diagram

The second data stored in special data register D8014 is compared with 0 using the CMP= (compare equal to) instruction. Each time the condition is met, the TXD2 instruction is executed to send the C2 and D30 data to the printer. A counting circuit for counter C2 is omitted from this sample program.

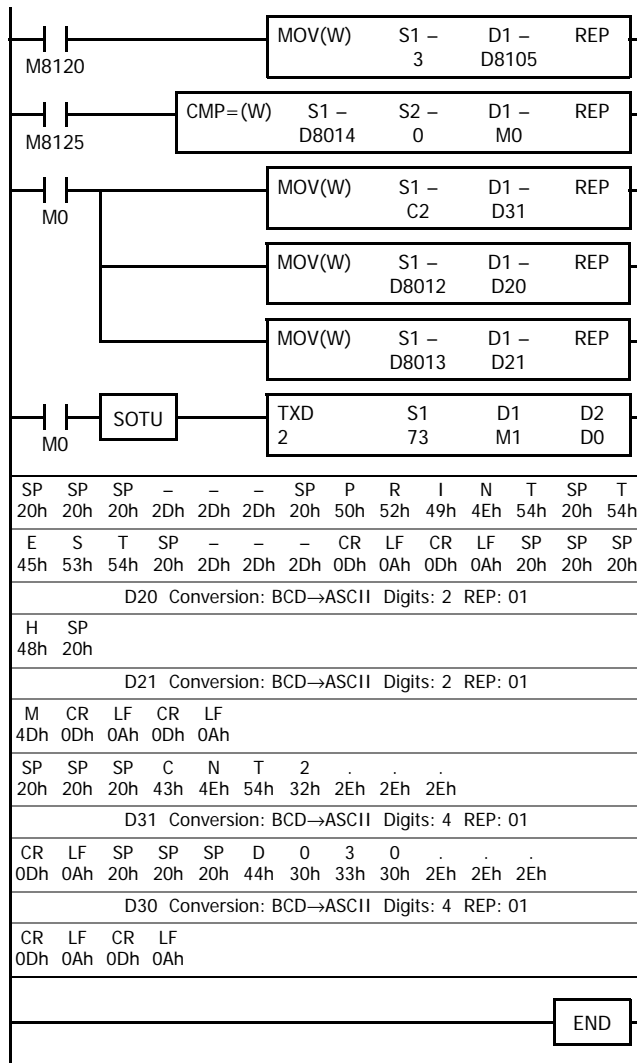

M8120 is the initialize pulse special internal relay.
 3 → D8105 to enable the DSR option for busy control.
 M8125 is the in-operation output special internal relay.
 CMP=(W) compares the D8014 second data with 0.
 When the D8014 data equals 0 second, M0 is turned on.
 Counter C2 current value is moved to D31.
 D8012 hour data is moved to D20.
 D8013 minute data is moved to D21.
 TXD2 is executed to send 73-byte data through the RS232C port 2 to the printer.
 D20 hour data is converted from BCD to ASCII, and 2 digits are sent.
 D21 minute data is converted from BCD to ASCII, and 2 digits are sent
 D31 counter C2 data is converted from BCD to ASCII, and 4 digits are sent.
 D30 data is converted from BCD to ASCII, and 4 digits are sent.

Sample Program – User Communication RXD

This example demonstrates a program to receive data from a barcode reader with an RS232C port using the user communication RXD2 (receive) instruction.

System Setup

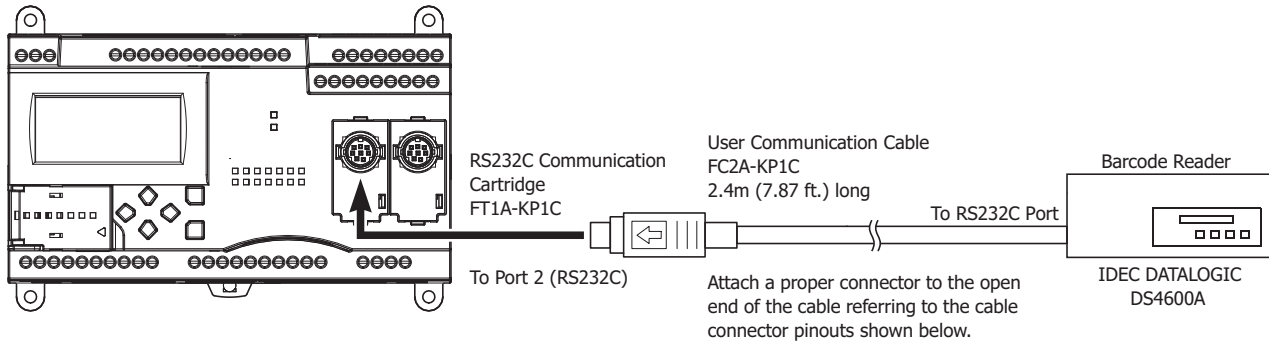

Mini DIN Connector Pinouts

Description	Color	Pin
Shield	—	Cover
NC No Connection	Black	1
NC No Connection	Yellow	2
TXD Transmit Data	Blue	3
RXD Receive Data	Green	4
NC No Connection	Brown	5
NC No Connection	Gray	6
SG Signal Ground	Red	7
NC No Connection	White	8

D-sub 25-pin Connector Pinouts

Pin	Description
1	FG Frame Ground
2	TXD1 Transmit Data
3	RXD1 Receive Data
7	GND Ground

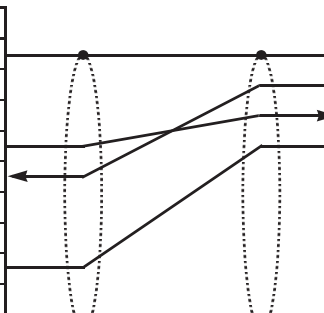

Caution

- Do not connect any wiring to the NC (no connection) pins; otherwise, the SmartAXIS and the barcode reader may not work correctly and may be damaged.

Description of Operation

A barcode reader is used to scan barcodes of 8 numerical digits. The scanned data is sent to the SmartAXIS through the RS232C port 2 and stored to data registers. The upper 8 digits of the data are stored to data register D20 and the lower 8 digits are stored to data register D21.

Setting User Communication Mode in WindLDR Function Area Settings

Since this example uses the RS232C port 2, select User Protocol for Port 2 in the Function Area Settings using WindLDR. See "Programming WindLDR" on page 10-4.

Setting Communication Parameters

Set the communication parameters to match those of the barcode reader. See "Programming WindLDR" on page 10-4. For details of the communication parameters of the barcode reader, see the user's manual for the barcode reader. An example is shown below:

Communication Parameters:

- Baud rate: 9600bps
- Data bits: 7
- Parity check: Even
- Stop bits: 1

Configuring Barcode Reader

The values shown below are an example of configuring a barcode reader. For actual settings, see the user's manual for the barcode reader.

Synchronization mode	Auto			
Read mode	Single read or multiple read			
Communication parameter	Baud rate:	9600bps	Data bits:	7
	Parity check:	Even	Stop bit:	1
Other communication settings	Header:	02h	Terminator:	03h
	Data echo back:	No	BCR data output:	Yes
	Output timing:	Output priority 1	Character suppress:	No
	Data output filter:	No	Main serial input:	No
	Sub serial:	No		
Comparison preset mode	Not used			

Device Addresses

M100	Input to start receiving barcode data
M101	Receive completion output for barcode data
M8120	Initialize pulse special internal relay
D20	Store barcode data (upper 4 digits)
D21	Store barcode data (lower 4 digits)
D100	Receive status data register for barcode data
D101	Receive data byte count data register

Ladder Diagram

When the SmartAXIS starts operation, the RXD2 instruction is executed to wait for incoming data. When data receive is complete, the data is stored to data registers D20 and D21. The receive completion signal is used to execute the RXD2 instruction to wait for another incoming data.

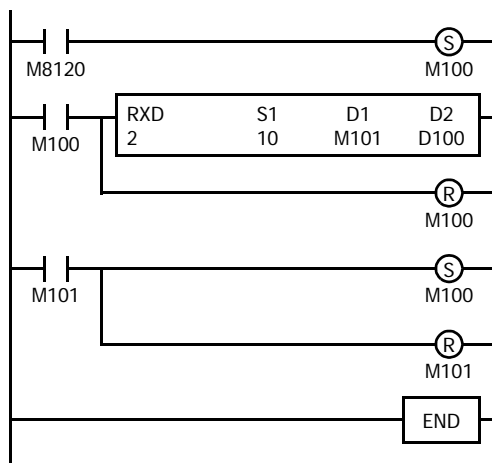

M8120 is the initialize pulse special internal relay used to set M100.

At the rising edge of M100, RXD2 is executed to be ready for receiving data.

Even after M100 is reset, RXD2 still waits for incoming data.

When data receive is complete, M101 is turned on, then M100 is set to execute RXD2 to receive the next incoming data.

RXD2 Data

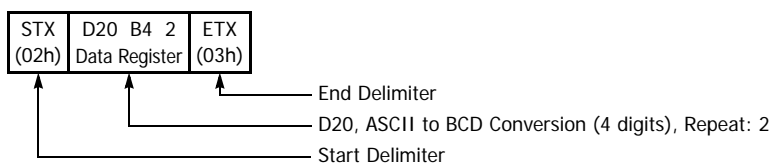

BCC Calculation Examples

The SmartAXIS can use three new BCC calculation formulas of ADD-2comp, Modbus ASCII, and Modbus RTU for transmit instructions TXD2 and TXD3 and receive instructions RXD2 and RXD3. These block check characters are calculated as described below.

ADD-2comp

Add the characters in the range from the BCC calculation start position to the byte immediately before the BCC, then invert the result bit by bit, and add 1.

1. Add the characters in the range from the BCC calculation start position to the byte immediately before the BCC.
2. Invert the result bit by bit, and add 1 (2's complement).
3. Store the result to the BCC position according to the designated conversion type (Binary to ASCII conversion or No conversion) and the designated quantity of BCC digits.

Example: Binary to ASCII conversion, 2 BCC digits

When the result of step **2** is 175h, the BCC will consist of 37h, 35h.

Modbus ASCII — Calculating the LRC (longitudinal redundancy check)

Calculate the BCC using LRC (longitudinal redundancy check) for the range from the BCC calculation start position to the byte immediately before the BCC.

1. Convert the ASCII characters in the range from the BCC calculation start position to the byte immediately before the BCC, in units of two characters, to make 1-byte hexadecimal data. (Example: 37h, 35h → 75h)
2. Add up the results of step **1**.
3. Invert the result bit by bit, and add 1 (2's complement).
4. Convert the lowest 1-byte data to ASCII characters. (Example: 75h → 37h, 35h)
5. Store the two digits to the BCC (LRC) position.

If the BCC calculation range consists of an odd number of bytes, the BCC calculation results in an indefinite value. Modbus protocol defines that the BCC calculation range is an even number of bytes.

Modbus RTU — Calculating the CRC-16 (cyclic redundancy checksum)

Calculate the BCC using CRC-16 (cyclic redundancy checksum) for the range from the BCC calculation start position to the byte immediately before the BCC. The generation polynomial is: $X^{16} + X^{15} + X^2 + 1$.

1. Take the exclusive OR (XOR) of FFFFh and the first 1-byte data at the BCC calculation start position.
2. Shift the result by 1 bit to the right. When a carry occurs, take the exclusive OR (XOR) of A001h, then go to step **3**.
If not, directly go to step **3**.
3. Repeat step **2**, shifting 8 times.
4. Take the exclusive OR (XOR) of the result and the next 1-byte data.
5. Repeat step **2** through step **4** up to the byte immediately before the BCC.
6. Swap the higher and lower bytes of the result of step **5**, and store the resultant CRC-16 to the BCC (CRC) position. (Example: 1234h → 34h, 12h)

11: MODBUS COMMUNICATION

Introduction

The SmartAXIS supports the Modbus communications protocols.

When a communication cartridge is installed on the expansion communication port, Modbus RTU protocol can be used. The SmartAXIS can communicate with hardware devices supporting Modbus RTU protocol via RS-232C/RS-485.

Modbus TCP protocol can also be used on the built-in Ethernet port. The SmartAXIS can communicate with hardware devices supporting Modbus TCP protocol via Ethernet.

Modbus Communication via RS-232C/RS-485

Applicable SmartAXIS

FT1A-12	FT1A-24	FT1A-40	FT1A-48
—	X	X	X

The SmartAXIS supports the Modbus RTU protocol and can be used as the Modbus RTU master and the Modbus RTU slave. When configured as a Modbus RTU master, the SmartAXIS can monitor and change the data of Modbus RTU slave devices. When the SmartAXIS is configured as a Modbus RTU slave, the device data of the SmartAXIS can be monitored and changed from the Modbus RTU master device.

For the Modbus RTU master function and how to configure it, see "Modbus Master Communication" on page 11-2. For the Modbus RTU slave function and how to configure it, see "Modbus Slave Communication Specifications" on page 11-8.

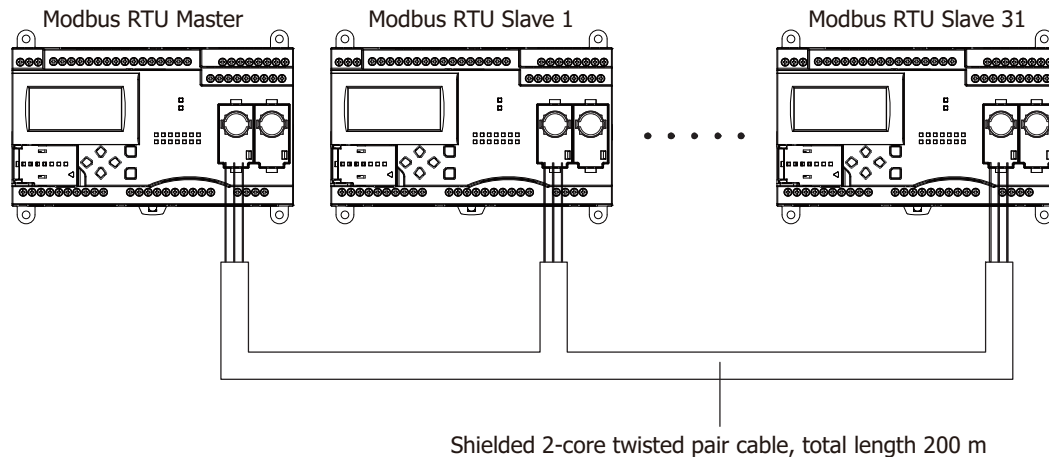

Notes:

- Modbus communication of the SmartAXIS does not support ASCII mode. Configure all the Modbus devices to communicate with as in RTU mode.
- The 24-I/O type has one expansion communication port. The 40- and 48-I/O types have two expansion communication ports. The 12-I/O type has no expansion communication port.

11: MODBUS COMMUNICATION

Modbus Master Communication

When configured as a Modbus master, the SmartAXIS sends communication requests to Modbus slaves to read/write data. Each communication request is sent to a Modbus slave according to the configured request table.

Modbus master communication settings and request tables for Modbus slave stations can be programmed using the WindLDR Function Area Settings. Communication with slave stations are performed in synchronism with user program execution, and the communication data are processed at the END processing in the order of request numbers specified in the request table. When request execution devices are designated, requests are executed only when the corresponding request execution device is turned on. When request execution devices are not designated, all requests are executed continuously.

Modbus Master Communication Specifications

Item	Description
Baud Rate (bps)	9600, 19200, 38400, 57600, 115200
Data Bits	8 bits (fixed)
Stop bits	1, 2 bits
Parity	Even, Odd, None
Slave Number	1 to 247 (0: broadcast slave number) ^{*1}
Maximum Number of Slaves	31
Receive Timeout ^{*2}	10 to 2550 ms (in increments of 10 ms)
Timeout between Characters	10 ms
Transmission Wait Time	1 to 5000 ms (in increments of 1 ms)
Retry Cycles	1 to 10

*1: A communication request becomes the broadcast when slave number 0 is specified. The broadcast communication request is received by all Modbus RTU slaves. Modbus RTU slave does not reply to the broadcast communication. Broadcast can be used to write the same data to all Modbus RTU slaves.

*2: Specifies the period of time before receiving a response frame from a slave.

Modbus Master Communication Start and Stop

When request execution devices are designated in the Modbus master request table, internal relays or data register bits as many as the request quantity are allocated to execute Modbus master communication. The internal relays or data register bits are allocated in the order of requests. For example, when internal relay M0 is designated as the request execution device, M0 is allocated to request No. 1, M1 to request No. 2, and so on. To execute a request, turn on the corresponding request execution device.

When communication is completed, the request execution device turns off automatically. When it is required to send requests continuously, keep the corresponding request execution device on using a SET or OUT instruction.

When request execution devices are not designated, all requests programmed in the request table are executed continuously.

Communication Completion and Communication Error

Modbus communication finishes when a read or write process is completed successfully or when a communication error occurs. Communication error occurs when communication failure has repeated more than the designated retry cycles or when the master station does not receive response within the designated receive timeout period. When a communication error occurs, the request is canceled and the next request is processed. When the error status data register is designated, the communication status of each request can be confirmed.

Note: Modbus master processes a maximum of one Modbus request per scan.

Communication Error Data

When Error Status is configured in the Request Table from the Function Area Settings, the error data of each request can be confirmed.

Use a single DR for all communication requests	Error data of each communication request
Unchecked	Error data, the remote host number (high-order byte) and error code (low-order byte), of each request in the entire request table can be confirmed. Data registers as many as the quantity of requests are reserved for storing error data. When an error occurs for a request, error data is stored to the corresponding data register.
Checked	A single data register is shared by all requests. When an error occurs for a request, error data is stored to the data register and the old error data is overwritten.
Bit Allocation	
Remote Host Number (high-order byte)	1 to 255
Error Code (low-order byte)	00h: Normal completion 01h: Function code error (unsupported function code) 02h: Access destination error (address out of range, address+device quantity out of range) 03h: Device quantity error, 1-bit write data error (specified device quantity of 1-bit write is unsupported) 12h: Frame length error (frame length of transmitted request exceeds range) 13h: BCC error (BCC does not match) 14h: Slave number error (received slave number is invalid) 16h: Timeout error (timeout occurs)

Communication Error Data of Each Request

Error data of each request in the entire request table can be confirmed. To confirm error data of each request, select to use Error Status in the Request Table from the Function Area Settings and enter the data register number.

When Use a single DR for all communication requests is not selected, starting with the data register number, data registers as many as the quantity of requests are reserved for storing error data. When an error occurs for a request, an error code is stored to a corresponding data register.

When Use a single DR for all communication requests is selected, the same data register is shared by all requests. When an error occurs for a request, an error code is stored to the data register and the old value is overwritten.

Number of Requests in Modbus Master

The number of requests that can be programmed in a request table is shown in the table below:

Port	Port 2 and Port 3
No. of requests	255

Note: 8 bytes of the user program area are needed per each request.

11: MODBUS COMMUNICATION

Programming Modbus Master Using WindLDR

Modbus master communication is programmed for Modbus RTU mode using WindLDR. Since these settings relate to the user program, the user program must be downloaded to the SmartAXIS after changing any of these settings.

1. From the WindLDR menu bar, select **Configuration > Communication Ports**.

The Function Area Settings dialog box for Communication Ports appears.

2. In the Communication Mode pull-down list for Port 2, select **Modbus RTU Master**.

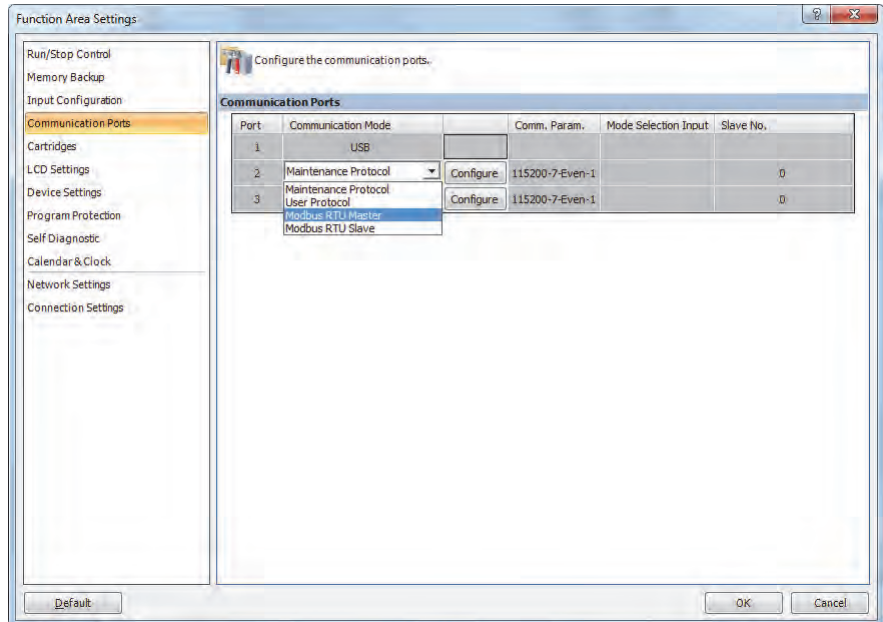

3. Click the **Configure** button for Port 2. The Modbus RTU Master Request Table appears.

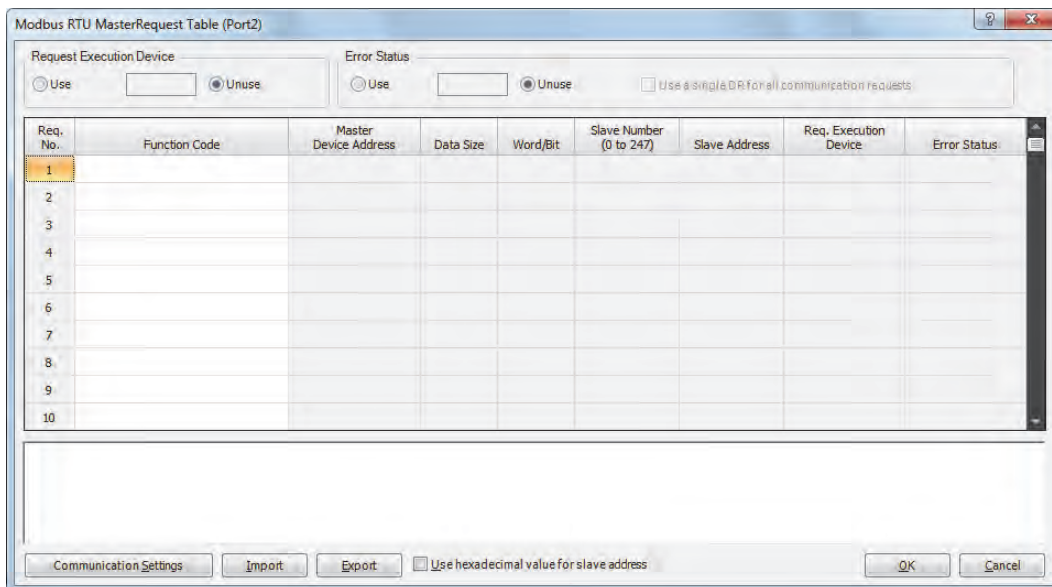

- Click the **Communication Settings** button. The Communication Settings dialog box appears. Change settings, if required.

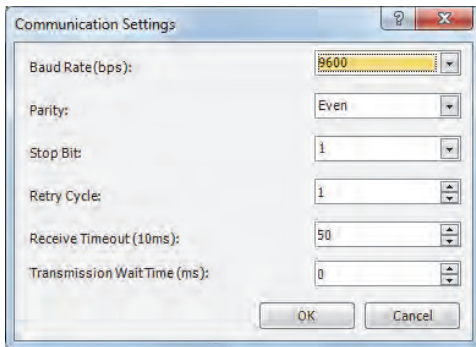

Baud Rate (bps)	9600, 19200, 38400, 57600, 115200
Parity	Even, Odd, None
Stop Bits	1 or 2
Retry Cycle	1 to 10
Receive Timeout	1 to 255 (×10ms)
Transmission Wait Time	0 to 5000 (ms)

- Click the **OK** button to return to the Modbus RTU Master Request Table. Designate requests under the Function Code. A maximum of 255 requests can be entered in one request table.

Choose to use Request Execution Devices and Error Status data registers if necessary. When using Request Execution Devices and Error Status data registers, enter the first number of the devices.

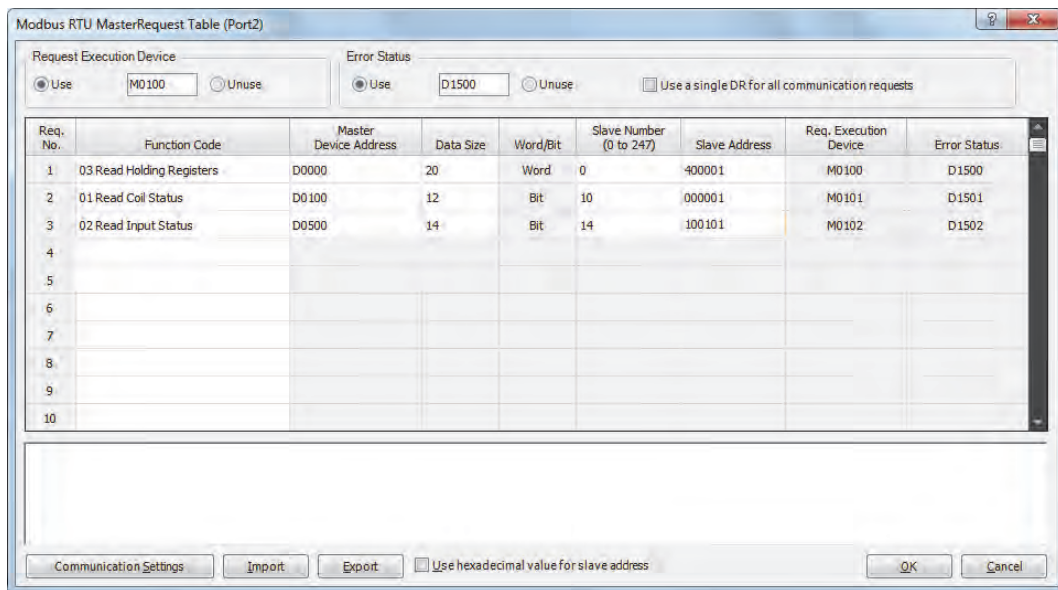

Notes for Editing the Request Table

Request execution devices and error status data registers are allocated in the order of request numbers. When deleting a request or changing the order of requests, the relationship of the request to the request execution devices and error status data register is changed. If the internal relay or data register is used in the user program, the device addresses must be changed accordingly. After completing the changes, download the user program again.

- When editing of the Master Request Table is complete, click the **OK** button to save changes.
- Download the user program to the SmartAXIS.
Now, programming for the Modbus master is complete. Details about parameters and valid values are as follows.

11: MODBUS COMMUNICATION

Function Code

The Modbus RTU of the SmartAXIS supports eight function codes as listed in the table below. Supported function codes and valid slave addresses vary with each Modbus slave device to communicate with. Configure the function codes according to the specifications of the Modbus slave devices.

Function Code	Data Size	Slave Address	SmartAXIS as Modbus Slave
01 Read Coil Status	1 to 128 bits	000001 - 065535	Reads bit device statuses of Q (output), R (shift register), or M (internal relay).
02 Read Input Status	1 to 128 bits	100001 - 165535	Reads bit device statuses of I (input), T (timer contact), or C (counter contact).
03 Read Holding Registers	1 to 64 words	400001 - 465535	Reads word device data of D (data register), T (timer preset value), or C (counter preset value).
04 Read Input Registers	1 to 64 words	300001 - 365535	Reads word device data of T (timer current value) or C (counter current value).
05 Force Single Coil	1 bit	000001 - 065535	Changes a bit device status of Q (output), R (shift register), or M (internal relay).
06 Preset Single Register	1 word	400001 - 465535	Changes word device data of D (data register).
15 Force Multiple Coils	1 to 128 bits	000001 - 065535	Changes multiple bit device statuses of Q (output), R (shift register), or M (internal relay).
16 Preset Multiple Registers	1 to 64 words	400001 - 465535	Changes multiple word device data of D (data register).

Master Device Address

When function code 01, 02, 03, or 04 is selected to read data from Modbus slaves, designate the first data register or internal relay number to store the data received from the Modbus slave. When function code 05, 06, 15, or 16 is selected to write data to Modbus slaves, designate the first data register or internal relay number to store the data to write to the Modbus slave. Data registers and internal relays can be designated as the master device address.

Data Size and Word/Bit

Designate the quantity of data to read or write. The valid data size depends on the function code. When function code 01, 02, 05, or 15 is selected, designate the data size in bits. When function code 03, 04, 06, or 16 is selected, designate the data size in words. For valid data sizes, see the table above.

Slave No.

Designate slave numbers 0 through 247. The same slave number can be designated repeatedly for different request numbers which can be 1 through 255. In the Modbus communication, slave number 0 is used for a broadcast slave number. The broadcast can be used to write the same data to all Modbus slaves.

Slave Address

Designate data memory addresses of Modbus slaves. The valid slave address range depends on the function code. For valid slave addresses, see the table above. The allocations of memory addresses vary with each Modbus slave device. Refer to manuals for each Modbus slave device.

Request Execution Device

To use request execution devices, click the radio button for "Use" and designate the first internal relay in the Modbus RTU Master Request Table. Devices used for executing requests are automatically listed in the table. To execute a request, turn on the corresponding request execution device.

Data registers can also be designated as the Request Execution Device. When the first data register is designated as the Request Execution Device, data register bits as many as the number of requests are allocated from the least significant bit of the first data register. Data register bits assigned as the execution relays are automatically listed in the Request Table.

When request execution devices are not designated, all requests programmed in the Request Table are executed continuously.

Error Status Data Register

To use error status data registers, click the radio button for "Use" and designate the first data register in the Modbus RTU Master Request Table. Data registers used for storing error statuses are automatically listed in the table. When Use a single DR for all communication requests is selected, the first data register is shared by all requests.

Processing Requests

The data for Modbus communication are processed between the master and slaves as shown below.

Bit Data at Slaves (Function Codes 01, 02, 05, and 15)

- Master Device Address: Internal Relay

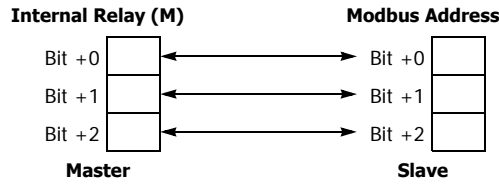

- Master Device Address: Data Register

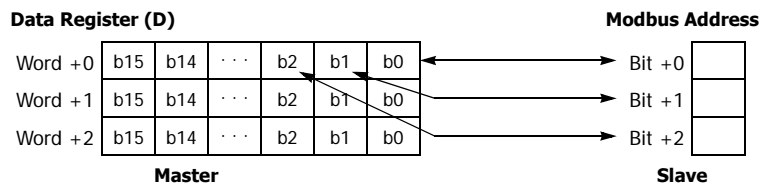

Word Data at Slaves (Function Codes 03, 04, 06, and 16)

- Master Device Address: Internal Relay

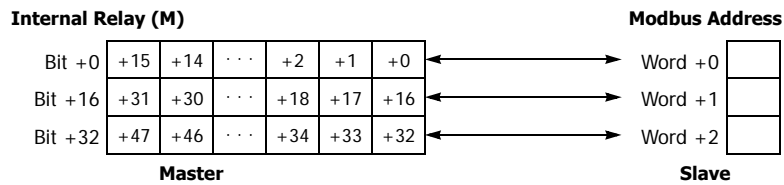

- Master Device Address: Data Register

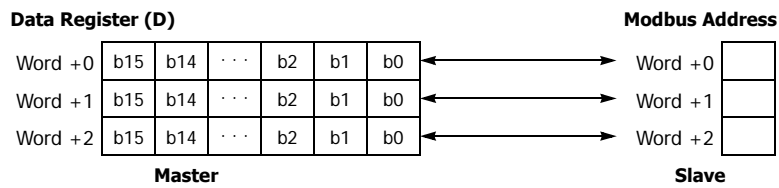

11: MODBUS COMMUNICATION

Modbus Slave Communication

Modbus slave communication can be configured by selecting Modbus RTU Slave for port 2 and port 3 in the WindLDR Function Area Settings. When a Modbus slave receives a request from the Modbus master, the Modbus slave reads or writes data according to the request. The request is processed at the END processing of the user program.

Modbus slaves do not reply to the Modbus master for the broadcast requests.

Modbus Slave Communication Specifications

Item	Description	
Baud Rate (bps)	9600, 19200, 38400, 57600, 115200	
Data Bits	8 bits (fixed)	
Stop bits	1, 2 bits	
Parity	Odd, even, none	
Slave Number	Constant	1 to 247
	Data register	The value in D8027 (port 2) or D8028 (port 3) is used
Timeout between Characters ^{*1}	1.5 characters minimum ^{*2}	
Timeout between Frames ^{*1}	3.5 characters minimum ^{*3}	

*1: When timeout occurs, the SmartAXIS discards the received data and waits for the first frame of the next valid communication.

*2: For communication at 19200bps or higher, the timeout between characters needs to be a minimum of 0.75ms.

*3: For communication at 19200bps or higher, the timeout between frames needs to be a minimum of 1.75ms.

Address Map

Modbus Device Name	Modbus Address Map (Decimal) *1	Communication Frame Address *2	SmartAXIS Device *3	Applicable Function Code
Coil (000000 and above)	000001 - 000112	0000 - 006F	Q0 - Q141	1, 5, 15
	000701 - 000828	02BC - 033B	R0 - R127	
	001001 - 002024	03E8 - 07E7	M0 - M1277	
	009001 - 009144	2328 - 23B7	M8000 - M8177	
Input Relay (100000 and above)	100001 - 100126	0000 - 007D	I0 - I155	2
	101001 - 101200	03E8 - 04AF	T0 - T199 (timer contact)	
	101501 - 101700	05DC - 06A3	C0 - C199 (counter contact)	
Input Register (300000 and above)	300001 - 300200	0000 - 00C7	T0 - T199 (timer current value)	4
	300501 - 300700	01F4 - 02BB	C0 - C199 (counter current value)	
Holding Register (400000 and above)	400001 - 402000	0000 - 07CF	D0 - D1999	3, 6, 16
	408001 - 408200	1F40 - 2007	D8000 - D8199	
	409001 - 409200	2328 - 23EF	T0 - T199 (timer preset value)	3
	409501 - 409700	251C - 25E3	C0 - C199 (counter preset value)	

*1: Addresses generally used for Modbus communication. Calculation method of Modbus addresses for SmartAXIS devices are described below.

*2: These 4-digit addresses are used in the communication frame. To calculate the address used in communication frame, extract lower 5 digits of the Modbus address, subtract 1 from the value, and convert the result into hexadecimal.

*3: Access within the device range for the SmartAXIS type used.

Calculating Modbus Addresses for SmartAXIS Devices

SmartAXIS Device	Calculating Modbus Address	Calculation Example
I, Q, M M <u>XXX</u> X (2): Octal (1): Decimal	$((1) - (4)) \times 8 + (2) + (5)$ Minimum address Offset	Example: M325 $(32 - 0) \times 8 + 5 + 1001 = 1262$ Modbus address: 1262 $1262 - 1 = 1261 = 04ED$ Communication frame address: 04ED
R, T, C, D D <u>XXXXX</u> (3): Decimal	$((3) - (4)) + (5)$ Minimum address Offset	Example: D756 $(756 - 0) + 400001 = 400757$ Modbus address: 400757 Extract lower 5 digits → 757 $757 - 1 = 756 = 02F4$ Communication frame address: 02F4

Modbus Device Name	SmartAXIS Device	Minimum Address (4)	Offset (5)
Coil	Q0 - Q141	0	1
	R0 - R127	0	701
	M0 - M1277	0	1001
	M8000 - M8177	8000	9001
Input Relay	I0 - I155	0	100001
	T0 - T199 (timer contact)	0	101001
	C0 - C199 (counter contact)	0	101501
Input Register	T0 - T199 (timer current value)	0	300001
	C0 - C199 (counter current value)	0	300501
Holding Register	D0 - D1999	0	400001
	D8000 - D8199	8000	408001
	T0 - T199 (timer preset value)	0	409001
	C0 - C199 (counter preset value)	0	409501

11: MODBUS COMMUNICATION

Programming Modbus Slave Using WindLDR

Modbus slave communication is programmed for Modbus RTU mode using WindLDR. Since these settings relate to the user program, the user program must be downloaded to the SmartAXIS after changing any of these settings.

1. From the WindLDR menu bar, select **Configuration > Communication Ports**.
The Function Area Settings dialog box for Communication Ports appears.
2. In the Communication Mode pull-down list for Port 2, select **Modbus RTU Slave**.

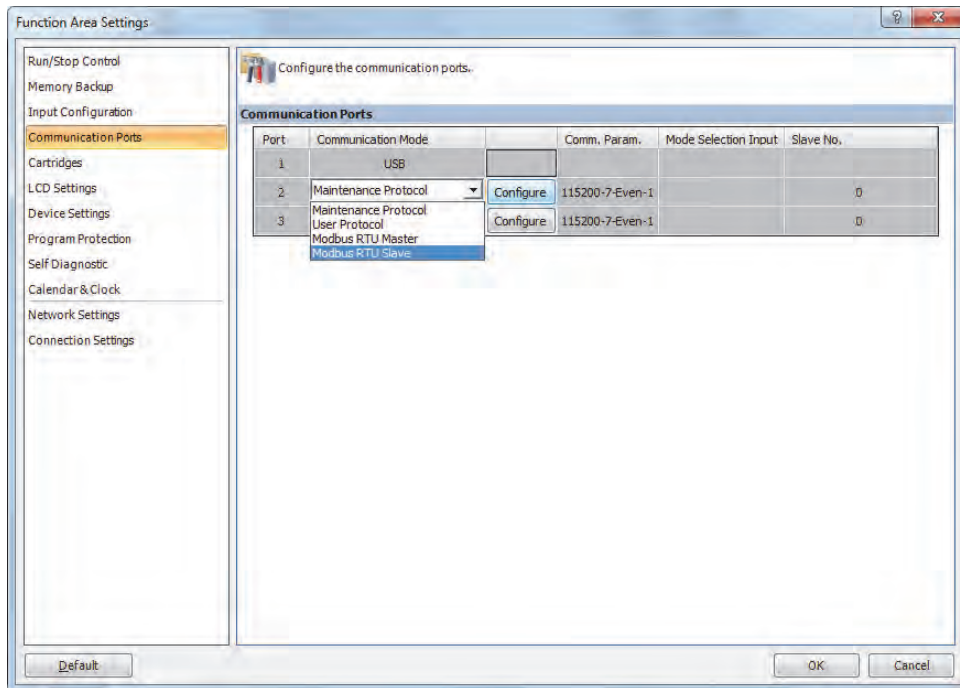

3. Click the **Configure** button. The Communication Parameters dialog box appears. Change settings, if required.

Modbus RTU Slave

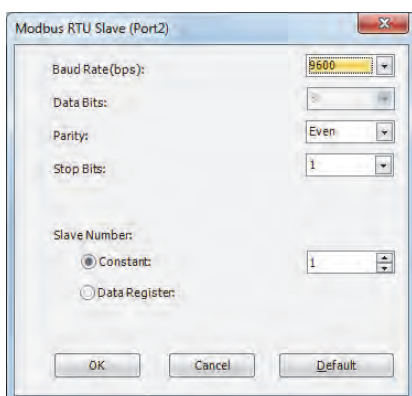

Baud Rate (bps)	9600	
	19200	
	38400	
	57600	
	115200	
Data Bits	8	
Parity	Even, Odd, None	
Stop Bits	1 or 2	
Slave Number	Constant	1 to 247
	Data register	The value in D8027 (port 2) or D8028 (port 3) is used

4. Click the **OK** button to save changes.
5. Download the user program to the SmartAXIS.
Now, programming for the Modbus slave is complete. Details about parameters and valid values are as follows.

Communication Protocol

This section describes the communication frame format used for Modbus RTU communication.

Communication Frame Format

Request from Modbus Master

Idle 3.5 characters	Slave No.	Function Code	Data	CRC	Idle 3.5 characters
	1 byte	1 byte		2 bytes	

ACK Reply from Modbus Slave

Idle 3.5 characters	Slave No.	Function Code	Data	CRC	Idle 3.5 characters
	1 byte	1 byte		2 bytes	

NAK Reply from Modbus Slave

Idle 3.5 characters	Slave No.	Function Code + 80H	Error Code	CRC	Idle 3.5 characters
	1 byte	1 byte	1 byte	2 bytes	

Note: Note: Idle means no data flowing on the communication line.

Communication Frame Format

RTU mode requires a minimum of 3.5-character-long idle time between frames to determine the beginning of a frame. The SmartAXIS Modbus master sends requests at idle intervals of 5ms, which can be changed in the Function Area Settings dialog box.

Slave No.

The SmartAXIS can be assigned slave numbers 1 through 247. In the 1:1 communication using RS232C, the same slave number must be set in the master and the SmartAXIS.

Slave No. 0 is reserved for broadcast slave number and is used to write the same data to all Modbus slaves. In this case, the Modbus slaves do not send a reply to the master.

Modbus Communication NG Reply Error Code

One of the following error codes is stored in NAK reply.

- 01h: Function code error (unsupported function code)
- 02h: Access destination error (address out of range, address+device quantity out of range)
- 03h: Device quantity error, 1-bit write data error

CRC

RTU mode uses CRC check codes.

• Modbus RTU Mode — Calculating the CRC-16 (cyclic redundancy checksum)

Calculate the BCC using CRC-16 for the range from the slave number to the byte immediately before the BCC. The generation polynomial is: $X^{16} + X^{15} + X^2 + 1$.

1. Take the exclusive OR (XOR) of FFFFh and the first 1-byte data at the slave number.
2. Shift the result by 1 bit to the right. When a carry occurs, take the exclusive OR (XOR) of A001h, then go to step 3. If not, directly go to step 3.
3. Repeat step 2, shifting 8 times.
4. Take the exclusive OR (XOR) of the result and the next 1-byte data.
5. Repeat step 2 through step 4 up to the byte immediately before the BCC.
6. Swap the higher and lower bytes of the result of step 5, and store the resultant CRC-16 to the BCC (CRC) position. (Example: 1234h → 34h, 12h)

11: MODBUS COMMUNICATION

Communication Format

This section describes the communication format for each function code from the slave number up to immediately before the check code.

Function Code 01 (Read Coil Status) and Function Code 02 (Read Input Status)

Function code 01 reads bit device statuses of Q (output), R (shift register), or M (internal relay). One through 128 consecutive bits can be read out.

Function code 02 reads bit device statuses of I (input), T (timer contact), or C (counter contact). One through 128 consecutive bits can be read out.

Communication Frame

Request from Modbus Master

Slave No.	Function Code	Address	No. of Bits
xxh	01h / 02h	xxxxh	xxxxh

ACK Reply from Modbus Slave

Slave No.	Function Code	Quantity of Data	First 8 Bits	Second 8 Bits	...	Last 8 Bits
xxh	01h / 02h	xxh	xxh	xxh		xxh

NAK Reply from Modbus Slave

Slave No.	Function Code	Error Code
xxh	81h / 82h	xxh

Communication Example

Purpose	Read 15 bits starting at output Q10. $Q10 \rightarrow (1 - 0) \times 8 + 0 + 1 = 9$ Modbus address: 9 $9 - 1 = 8 = 8h$ Communication frame address: 0008h
Condition	Slave No. 8 Q10 through Q27 binary data: 1234h

• RTU Mode

Request from Modbus Master	08 01 0008 0010 (CRC)
ACK Reply from Modbus Slave	08 01 02 34 12 (CRC)
NAK Reply from Modbus Slave	08 81 xx (CRC)

Function Code 03 (Read Holding Registers) and Function Code 04 (Read Input Registers)

Function code 03 reads word device data of D (data register), T (timer preset value), or C (counter preset value). One through 64 consecutive words can be read out.



Function code 04 reads word device data of T (timer current value) or C (counter current value). One through 64 consecutive words can be read out.

Communication Frame

Request from Modbus Master

Slave No.	Function Code	Address	No. of Words
xxh	03h / 04h	xxxxh	xxxxh

ACK Reply from Modbus Slave

Slave No.	Function Code	Quantity of Data	First High Byte	First Low Byte		Last Low Byte
xxh	03h / 04h	xxh	xxh	xxh		xxh

NAK Reply from Modbus Slave

Slave No.	Function Code	Error Code
xxh	83h / 84h	xxh

Communication Example

Purpose	Read 2 words starting at data register D1710. $D1710 \rightarrow (1710 - 0) + 400001 = 401711$ Modbus address: 401711 Extract lower 5 digits $\rightarrow 1711$ $1711 - 1 = 1710 = 6AEh$ Communication frame address: 06AEh
Condition	Slave No. 8 D1710 data: 1234h D1711 data: 5678h

• **RTU Mode**

Request from Modbus Master	08 03 06AE 0002 (CRC)
ACK Reply from Modbus Slave	08 03 04 12 34 56 78 (CRC)
NAK Reply from Modbus Slave	08 83 xx (CRC)

11: MODBUS COMMUNICATION

Function Code 05 (Force Single Coil)

Function code 05 changes a bit device status of Q (output), R (shift register), or M (internal relay).

Communication Frame

Request from Modbus Master

Slave No.	Function Code	Address	OFF: 0000h ON: FF00h
xxh	05h	xxxxh	xxxxh

ACK Reply from Modbus Slave

Slave No.	Function Code	Address	OFF: 0000h ON: FF00h
xxh	05h	xxxxh	xxxxh

NAK Reply from Modbus Slave

Slave No.	Function Code	Error Code
xxh	85h	xxh

Communication Example

Purpose	Force internal relay M1320 on. $M1320 \rightarrow (132 - 0) \times 8 + 0 + 1001 = 2057$ Modbus address: 2057 $2057 - 1 = 2056 = 808h$ Communication frame address: 0808h
Condition	Slave No. 8

• RTU Mode

Request from Modbus Master	08 05 0808 FF00 (CRC)
ACK Reply from Modbus Slave	08 05 0808 FF00 (CRC)
NAK Reply from Modbus Slave	08 85 xx (CRC)

Function Code 06 (Preset Single Register)

Function code 06 changes word device data of D (data register).

Communication Frame

Request from Modbus Master

Slave No.	Function Code	Address	New Data
xxh	06h	xxxxh	xxxxh

ACK Reply from Modbus Slave

Slave No.	Function Code	Address	Acknowledge Data
xxh	06h	xxxxh	xxxxh

NAK Reply from Modbus Slave

Slave No.	Function Code	Error Code
xxh	86h	xxh

Communication Example

Purpose	Write 8000 to data register D1708. $D1708 \rightarrow (1708 - 0) + 400001 = 401709$ Modbus address: 401709 Extract lower 5 digits $\rightarrow 1709$ $1709 - 1 = 1708 = 6ACh$ Communication frame address: 06ACh
Condition	Slave No. 8

• **RTU Mode**

Request from Modbus Master	08 06 06AC 1F40 (CRC)
ACK Reply from Modbus Slave	08 06 06AC 1F40 (CRC)
NAK Reply from Modbus Slave	08 86 xx (CRC)

11: MODBUS COMMUNICATION

Function Code 15 (Force Multiple Coils)

Function code 15 changes bit device statuses of Q (output), R (shift register), or M (internal relay). One through 128 consecutive bits can be changed.

Communication Frame

Request from Modbus Master

Slave No.	Function Code	Address	No. of Bits	Quantity of Data	First 8 Bits	Second 8 Bits		Last 8 Bits
xxh	0Fh	xxxxh	xxxxh	xxh	xxh	xxh		xxh

ACK Reply from Modbus Slave

Slave No.	Function Code	Address	No. of Bits
xxh	0Fh	xxxxh	xxxxh

NAK Reply from Modbus Slave

Slave No.	Function Code	Error Code
xxh	8Fh	xxh

Communication Example

Purpose	Write the following bit statuses to internal relays M605 through M624.																																															
	<table style="width: 100%; text-align: center;"> <tr> <td></td> <td></td> <td></td> <td></td> <td></td> <td>M605</td> <td>M606</td> <td>M607</td> </tr> <tr> <td></td> <td></td> <td></td> <td></td> <td></td> <td>(ON)</td> <td>(ON)</td> <td>(OFF)</td> </tr> <tr> <td>M610</td> <td>M611</td> <td>M612</td> <td>M613</td> <td>M614</td> <td>M615</td> <td>M616</td> <td>M617</td> </tr> <tr> <td>(ON)</td> <td>(OFF)</td> <td>(ON)</td> <td>(ON)</td> <td>(OFF)</td> <td>(OFF)</td> <td>(ON)</td> <td>(OFF)</td> </tr> <tr> <td>M620</td> <td>M621</td> <td>M622</td> <td>M623</td> <td>M624</td> <td></td> <td></td> <td></td> </tr> <tr> <td>(OFF)</td> <td>(OFF)</td> <td>(OFF)</td> <td>(OFF)</td> <td>(OFF)</td> <td></td> <td></td> <td></td> </tr> </table> <p>M605 (LSB) through M614 (MSB) binary data: 6B M615 (LSB) through M624 (MSB) binary data: 02 $M605 \rightarrow (60 - 0) \times 8 + 5 + 1001 = 1486$ Modbus address: 1486 $1486 - 1 = 1485 = 5CDh$ Communication frame address: 05CDh</p>						M605	M606	M607						(ON)	(ON)	(OFF)	M610	M611	M612	M613	M614	M615	M616	M617	(ON)	(OFF)	(ON)	(ON)	(OFF)	(OFF)	(ON)	(OFF)	M620	M621	M622	M623	M624				(OFF)	(OFF)	(OFF)	(OFF)	(OFF)		
					M605	M606	M607																																									
					(ON)	(ON)	(OFF)																																									
M610	M611	M612	M613	M614	M615	M616	M617																																									
(ON)	(OFF)	(ON)	(ON)	(OFF)	(OFF)	(ON)	(OFF)																																									
M620	M621	M622	M623	M624																																												
(OFF)	(OFF)	(OFF)	(OFF)	(OFF)																																												
Condition	Slave No. 8																																															

• RTU Mode

Request from Modbus Master	08 0F 05CD 0010 02 6B 02 (CRC)
ACK Reply from Modbus Slave	08 0F 05CD 0010 (CRC)
NAK Reply from Modbus Slave	08 8F xx (CRC)

Function Code 16 (Preset Multiple Registers)

Function code 16 changes word device data of D (data register). One through 64 consecutive words can be changed.

Communication Frame

Request from Modbus Master

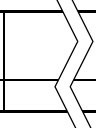
Slave No.	Function Code	Address	No. of Words	Quantity of Data	First High Byte	First Low Byte		Last Low Byte
xxh	10h	xxxxh	xxxxh	xxh	xxh	xxh		xxh

ACK Reply from Modbus Slave

Slave No.	Function Code	Address	No. of Words
xxh	10h	xxxxh	xxxxh

NAK Reply from Modbus Slave

Slave No.	Function Code	Error Code
xxh	90h	xxh

Communication Example

Purpose	Write the following data to four data registers D1708 through D1711. D1708 D1709 D1710 D1711 (1234h) (5678h) (ABCDh) (EF01h) D1708 → (1708 - 0) + 400001 = 401709 Modbus address: 401709 Extract lower 5 digits → 1709 1709 - 1 = 1708 = 6ACh Communication frame address: 06ACh
	Condition

- RTU Mode

Request from Modbus Master	08 10 06AC 0004 08 12 34 56 78 AB CD EF 01 (CRC)
ACK Reply from Modbus Slave	08 10 06AC 0004 (CRC)
NAK Reply from Modbus Slave	08 90 xx (CRC)

Modbus Communication via Ethernet Communication

Applicable SmartAXIS

FT1A-12	FT1A-24	FT1A-40	FT1A-48
—	X	X	X

The SmartAXIS supports Modbus TCP clients and Modbus TCP servers. Connect the Ethernet port on the SmartAXIS to enable the SmartAXIS to communicate with Modbus TCP compliant devices.

When configured as a Modbus TCP client, the SmartAXIS can monitor and change the data memory of the network devices supporting Modbus TCP server. A maximum of three connections can be allocated to Modbus TCP clients. Each connection can communicate with one Modbus TCP server device.

When the SmartAXIS is configured as a Modbus TCP server, the device data of the SmartAXIS can be monitored and changed from Modbus TCP client devices. The SmartAXIS can allocate a maximum of three connections for Modbus TCP servers.

For the Modbus TCP client function and how to configure it, see "Modbus TCP Client" on page 11-19. For the Modbus TCP server function and how to configure it, see "Modbus TCP Server" on page 11-24.

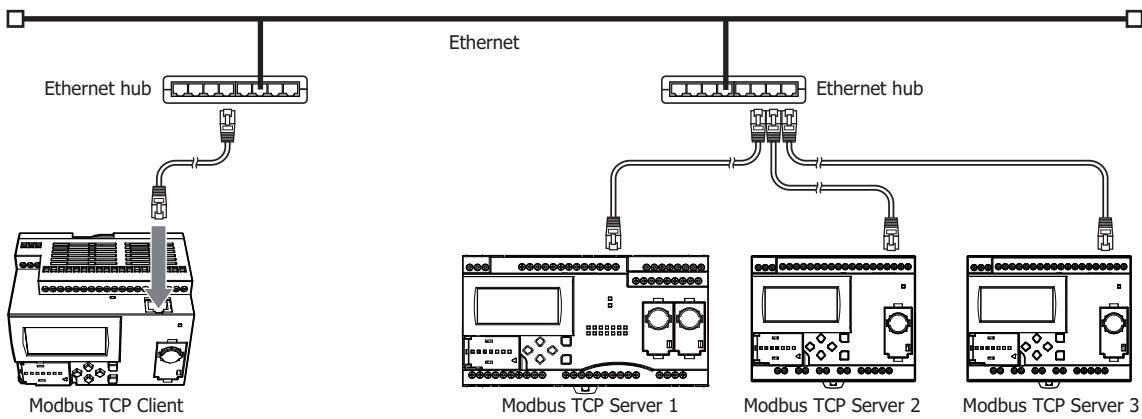

Modbus TCP Client

When configured as a Modbus TCP client, the SmartAXIS sends communication requests to a Modbus TCP server to read/write data. Each communication request is sent to a Modbus Server according to the configured request table.

Modbus TCP client communication settings and request tables for Modbus TCP servers can be configured using the WindLDR Function Area Settings. The SmartAXIS communicate with the Modbus TCP servers according to those settings.

Communication with Modbus TCP servers are performed in sync with the user program execution, and the communication data is processed at the END, in the order of request numbers specified in the request table.

Modbus TCP Client Specifications

Parameter	Modbus TCP Client
Slave Number	1 to 247
Maximum Number of Servers	3 (one server per one connection)
Receive Timeout ^{*1}	100 to 25,500ms (in increments of 100ms)

*1: Specifies the period of time before receiving a response frame from a server.

Modbus TCP Client Start and Stop

When request execution devices are designated in the Modbus TCP Client request table, internal relays or data register bits (as many as the request quantity) are allocated to execute Modbus TCP Client communication. The internal relays or data register bits are allocated in the order of requests. For example, when internal relay M0 is designated as the request execution device, M0 is allocated to request No. 1, M1 to request No. 2, and so on. To execute a request, turn on the corresponding request execution device.

When communication is completed, the request execution device turns off automatically. When it is required to send requests continuously, keep the corresponding request execution device on using a SET or OUT instruction.

When request execution devices are not designated, all requests programmed in the request table are executed continuously.

Communication Completion and Communication Error

Modbus communication finishes when a read or write process is completed successfully or when a communication error occurs.

A communication error occurs when communication failure has repeated three times. When a communication error occurs, the request is canceled and the next request is processed. When the error status data register is designated, the communication status of each request can be confirmed.

Communication Error Data

When Error Status is configured in the Request Table from the Function Area Settings, the error data of each request can be confirmed.

Use a single DR for all communication requests	Error data of each communication request
Unchecked	Error data, the remote host number (high-order byte) and error code (low-order byte), of each request in the entire request table can be confirmed. Data registers as many as the quantity of requests are reserved for storing error data. When an error occurs for a request, error data is stored to the corresponding data register.
Checked	A single data register is shared by all requests. When an error occurs for a request, error data is stored to the data register and the old error data is overwritten.

Bit Allocation	
Remote Host Number (high-order byte)	1 to 255
Error Code (low-order byte)	00h: Normal completion 01h: Function code error (unsupported function code) 02h: Access destination error (address out of range, address+device quantity out of range) 03h: Device quantity error, 1-bit write data error (specified device quantity of 1-bit write is unsupported) 12h: Frame length error (frame length of transmitted request exceeds range) 13h: BCC error (BCC does not match) 14h: Slave number error (received slave number is invalid) 16h: Timeout error (timeout occurs)

11: MODBUS COMMUNICATION

Modbus TCP Communication Request Table

A maximum of 255 requests can be configured in the Modbus TCP Client Request Table.

Notes:

- 10 bytes of the user program area are needed per each request.
- Request execution devices and error status data registers are allocated in the order of request numbers. When deleting a request or changing the order of requests, the relationship of the request to the request execution devices and error status data register is changed. If the allocated internal relays or data registers are used in the user program, those device addresses must be updated accordingly.

Programming WindLDR (Modbus TCP Client)

In order to use the Modbus TCP client, configure the Modbus TCP client in the Function Area Settings dialog box and then download the user program to the SmartAXIS.

1. From the WindLDR menu bar, select **Configuration > Connection Settings**.
The Function Area Settings dialog box appears.
2. Select **Modbus TCP Client** as the communication mode for the connection 1.

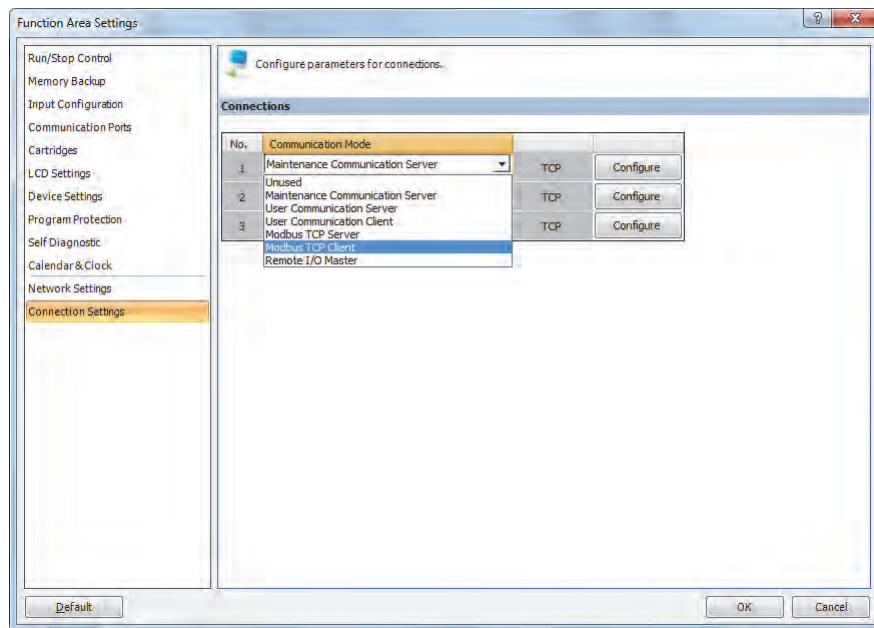

The Modbus TCP Client Request Table dialog box appears.

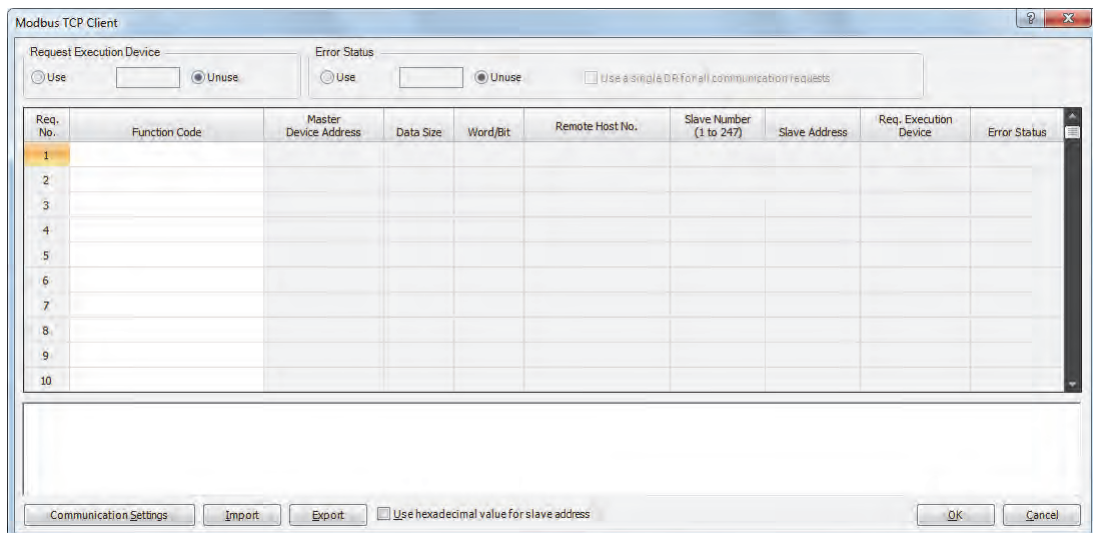

3. Click on the **Communication Settings** button.
The Communication Settings dialog box appears. Configure the timeout and click **OK** button to close the Communication Settings dialog box.

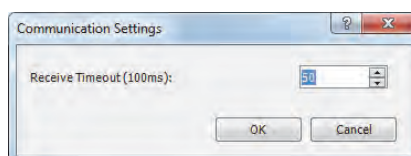

11: MODBUS COMMUNICATION

4. Configure the requests of the Modbus TCP Client.

A maximum of 255 requests can be entered in one request table. Specify the Modbus TCP servers with the remote host numbers. After all requests are configured, click **OK** button to close the dialog box.

Choose to use Request Execution Devices and Error Status data registers if necessary. When using Request Execution Devices and Error Status data registers, enter the first number of the devices.

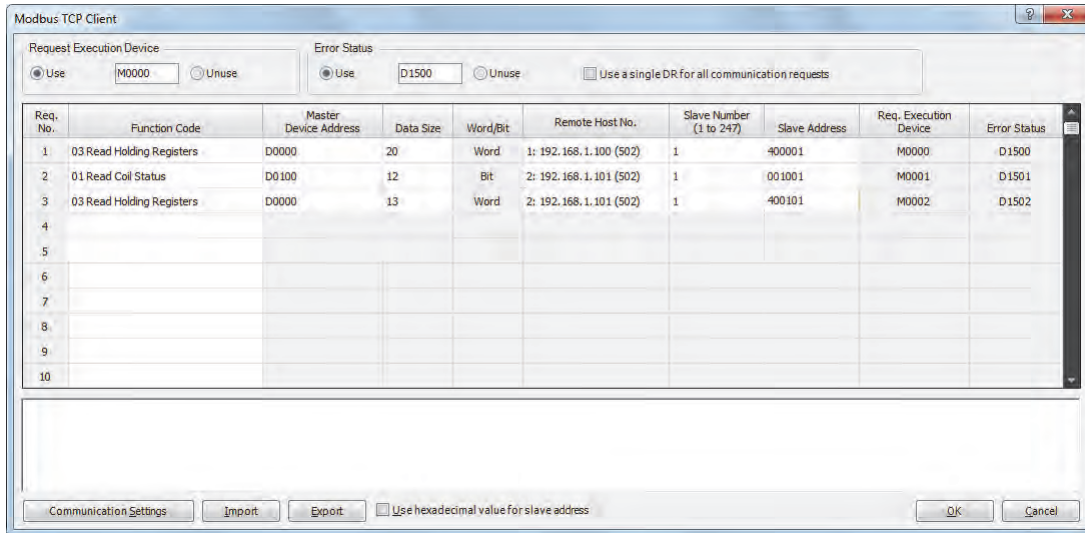

5. Download the user program to the SmartAXIS.

Programming for the Modbus TCP client is complete. Details about parameters and valid values are as follows.

Function Code

The Modbus TCP of the SmartAXIS supports eight function codes as listed in the table below. Supported function codes and valid slave addresses vary with each Modbus server device to communicate with. Configure the function codes according to the specifications of the Modbus server devices.

Function Code	Data Size	Slave Address	SmartAXIS as Modbus Slave
01 Read Coil Status	1 to 128 bits	000001 - 065535	Reads bit device statuses of Q (output), R (shift register), or M (internal relay).
02 Read Input Status	1 to 128 bits	100001 - 165535	Reads bit device statuses of I (input), T (timer contact), or C (counter contact).
03 Read Holding Registers	1 to 64 words	400001 - 465535	Reads word device data of D (data register), T (timer preset value), or C (counter preset value).
04 Read Input Registers	1 to 64 words	300001 - 365535	Reads word device data of T (timer current value) or C (counter current value).
05 Force Single Coil	1 bit	000001 - 065535	Changes a bit device status of Q (output), R (shift register), or M (internal relay).
06 Preset Single Register	1 word	400001 - 465535	Changes word device data of D (data register).
15 Force Multiple Coils	1 to 128 bits	000001 - 065535	Changes multiple bit device statuses of Q (output), R (shift register), or M (internal relay).
16 Preset Multiple Registers	1 to 64 words	400001 - 465535	Changes multiple word device data of D (data register).

Master Device Address

When function code 01, 02, 03, or 04 is selected to read data from Modbus servers, designate the first data register or internal relay number to store the data received from the Modbus server. When function code 05, 06, 15, or 16 is selected to write data to Modbus servers, designate the first data register or internal relay number to store the data to write to the Modbus server. Data registers and internal relays can be designated as the master device address.

Data Size and Word/Bit

Designate the quantity of data to read or write. The valid data size depends on the function code. When function code 01, 02, 05, or 15 is selected, designate the data size in bits. When function code 03, 04, 06, or 16 is selected, designate the data size in words. For valid data sizes, see "Function Code" on page 11-22.

Remote Host No.

Designate the remote host number configured in the Remote Host List dialog box. In the Remote Host List dialog box, IP address and port number are configured for each remote host. The default port number of Modbus TCP communication is 502. If the Modbus TCP server uses a different port number, configure that port number in the Remote Host List dialog box.

Slave No.

Designate slave numbers 1 through 247. The same slave number can be designated repeatedly for different request numbers which can be 1 through 255. The slave number is usually not referred by Modbus TCP server. Configure the slave number if Modbus TCP server requires.

Slave Address

Designate data memory addresses of Modbus servers. The valid slave address range depends on the function code. For valid slave addresses, see the table above. The allocations of memory addresses vary with each Modbus server device. Refer to manuals for each Modbus server device.

Request Execution Device

To use request execution devices, click the radio button for "Use" and designate the first internal relay or data register in the Modbus TCP Client Request Table. Internal relays or data register bits used for executing requests are automatically listed in the table. To execute a request, turn on the corresponding request execution device.

When request execution devices are not designated, all requests programmed in the Request Table are executed continuously.

Error Status Data Register

To use error status data registers, click the radio button for "Use" and designate the first data register in the Modbus TCP Client Request Table. Data registers used for storing error statuses are automatically listed in the table. When Use a single DR for all communication requests is selected, the first data register is shared by all requests.

11: MODBUS COMMUNICATION

Modbus TCP Server

When the SmartAXIS is configured as the Modbus TCP server, Modbus TCP client devices can read/write data to the SmartAXIS. When the SmartAXIS receives a valid request from a Modbus TCP client device, the data is read or written according to the request received. The communication data received from Modbus TCP clients is processed at the END processing of the user program.

Modbus TCP Server Specifications

Parameter	Modbus TCP Server
Slave Number	Ignored
Response Time	1.5 ms
Number of Clients that can Access Simultaneously	3 (1 client per 1 connection)
Port Number	502 (can be changed between 0 and 65535)
Supported Function Code	01 Read Coil Status 02 Read Input Status 03 Read Holding Registers 04 Read Input Registers 05 Force Single Coil 06 Preset Single Register 15 Force Multiple oils 16 Preset Multiple Registers

Address Map

Modbus TCP client can access the Modbus devices (Coil, Input Relay, Input Register, and Holding Register) of Modbus server to read or write the device data (I, Q, M, R, T, C, and D) of SmartAXIS. Refer to the following table to configure the Modbus TCP clients.

Modbus Device Name	Modbus Address Map (Decimal)	Communication Frame Address ^{*1}	SmartAXIS Device ^{*2}	Applicable Function Code
Coil (000000 and above)	000001 - 000112	0000 - 006F	Q0 - Q141	1, 5, 15
	000701 - 000828	02BC - 033B	R0 - R127	
	001001 - 002024	03E8 - 07E7	M0 - M1277	
	009001 - 009144	2328 - 23B7	M8000 - M8177	
Input Relay (100000 and above)	100001 - 100126	0000 - 007D	I0 - I155	2
	101001 - 101200	03E8 - 04AF	T0 - T199 (timer contact)	
	101501 - 101700	05DC - 06A3	C0 - C199 (counter contact)	
Input Register (300000 and above)	300001 - 300200	0000 - 00C7	T0 - T199 (timer current value)	4
	300501 - 300700	01F4 - 02BB	C0 - C199 (counter current value)	
Holding Register (400000 and above)	400001 - 402000	0000 - 07CF	D0 - D1999	3, 6, 16
	408001 - 408200	1F40 - 2007	D8000 - D8199	
	409001 - 409200	2328 - 23EF	T0 - T199 (timer preset value)	3
	409501 - 409700	251C - 25E3	C0 - C199 (counter preset value)	

*1: These 4-digit addresses are used in the communication frame. To calculate the address used in communication frame, extract lower 5 digits of the Modbus address, subtract 1 from the value, and convert the result into hexadecimal. For details, see "Modbus Slave Communication" on page 11-8.

*2: Access within the device range for the SmartAXIS type used.

Programming WindLDR (Modbus TCP Server)

In order to use Modbus TCP server, configure the Modbus TCP server in the Function Area Settings dialog box and then download the user program to the SmartAXIS.

1. From the WindLDR menu bar, select **Configuration > Connection Settings**.
The Function Area Settings dialog box appears.
2. Select **Modbus TCP Server** as the communication mode for connection 1.

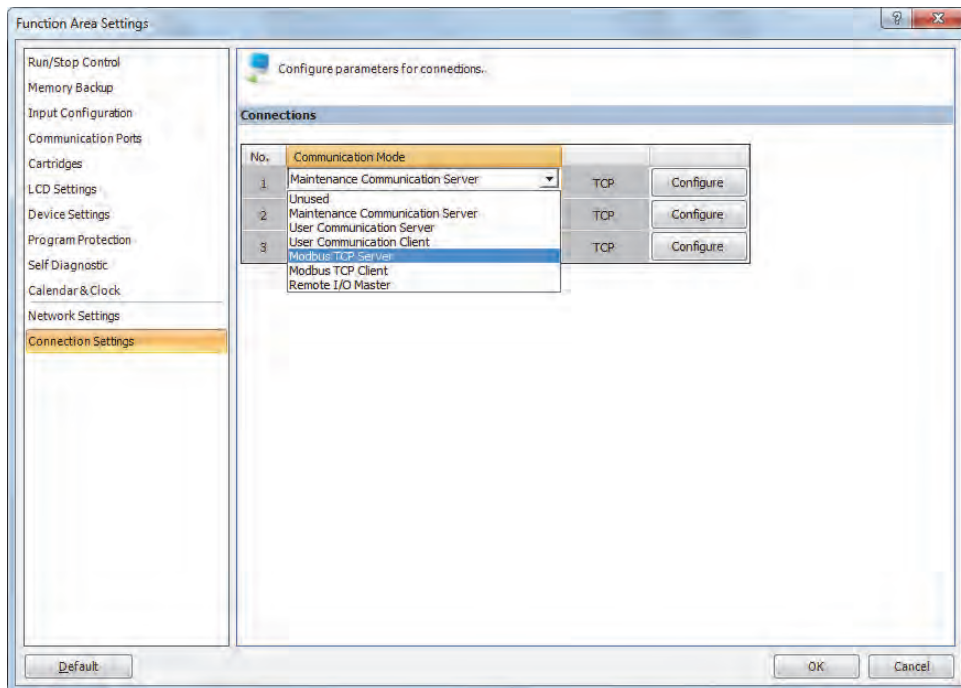

The Modbus TCP Server dialog box appears.

3. Configure the parameters and click on **OK** button.

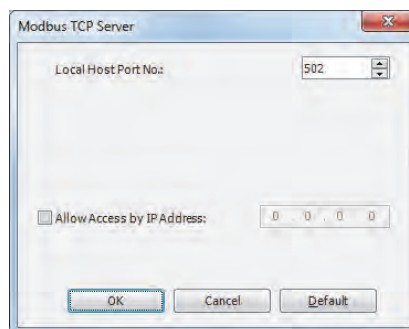

Note: For details about each parameter, see the following page.

4. Download the user program to the SmartAXIS.
Programming for the Modbus TCP server is complete.

11: MODBUS COMMUNICATION

Modbus TCP Server Communication Settings

Local Host Port No.

Configure the local host port number between 0 and 65,535. The same local host port number can be used with multiple connection numbers.

If the same port number is used with multiple connections, Modbus TCP clients (as many as the number of the connections) can communicate with SmartAXIS through the same port number.

Allow Access by IP Address

You can set the IP address for a device to permit access. By setting the allowed IP address, only the device with the specified IP address can establish a connection with the SmartAXIS and communicate with the Modbus TCP server. When the same local host port number is configured in multiple connections, all the allowed IP address settings are effective. If a connection in which the allowed IP address is not configured uses the same local host port number, arbitrary access is allowed through the port.

Example 1: If two connections use the same local port number and an allowed IP address is not configured for both connections, access from a total of two clients with any IP addresses is accepted.

Example 2: If two connections use the same local port number and 192.168.1.101 and 192.168.1.102 are configured as the allowed IP addresses, access from a total of two clients whose IP addresses are 192.168.1.101 and 192.168.1.102 is accepted.

Example 3: If connection 1 and 2 use the same local port number, an allowed IP address 192.168.1.101 is configured for connection 1, and the allowed IP address is not configured for connections, access from a total of two clients with any IP addresses is accepted.

Modbus TCP Communication Format

This section describes the communication format used for Modbus TCP client and server communication. Modbus TCP communication format starts with the Modbus TCP header followed by the RTU mode communication format without the idle 3.5 characters at both ends and CRC as shown below.

Modbus TCP Communication Format

Transaction ID	Protocol ID	Message Length (bytes)	Unit ID	Function Code	Data		
2 bytes	2 bytes	2 bytes	1 byte	1 byte	N bytes		
Modbus TCP Header							
RTU Mode Communication Format			Slave No.	Function Code	Data	CRC	Idle
			1 byte	1 byte	N bytes	2 bytes	3.5 characters

Transaction ID

The Modbus TCP server (slave) returns the request ID sent from the client (master) without any change. When receiving the returned request ID, the client can confirm to which request the response was returned. When confirmation is not required, designate 0 as a transaction ID.

Protocol ID

Designate 0 to identify Modbus TCP protocol.

Message Length

Designate the length of the following message in bytes.

Unit ID

The ID for identifying the device. Store the slave number of the Modbus TCP server. The SmartAXIS Modbus TCP server accepts and processes requests when the unit ID of the received request is not 0. When the unit ID is 0, the received request is processed as broadcast communication and no response is returned to the Modbus TCP client.

Function Code

Designate a function code, such as 01 (read coil status) and 02 (read input status).

Data

Designate required data for each function.

12: REMOTE I/O

Introduction

When you want to increase the number of I/Os to be connected to a single SmartAXIS, you can achieve this using the remote I/O function.

In addition to the built-in I/Os of the SmartAXIS, you can expand the number of I/Os up to a maximum of 90 inputs and 54 outputs.

The remote I/O function can only be used on the SmartAXIS equipped with an Ethernet port.

Configure the SmartAXIS to which inputs and outputs need to be expanded as the remote I/O master, and configure the SmartAXIS to be the remote inputs and outputs as the remote I/O slaves.

The remote I/O master is configured on connections 1 through 3 in the Function Area Settings dialog box. The remote I/O slave is configured in the Remote I/O Slave Configuration dialog box.

The SmartAXIS configured as a remote I/O master can connect to one remote I/O slave per one connection. When the connections 1 through 3 are all used for remote I/O, the remote I/O master can connect to a maximum of three remote I/O slaves.

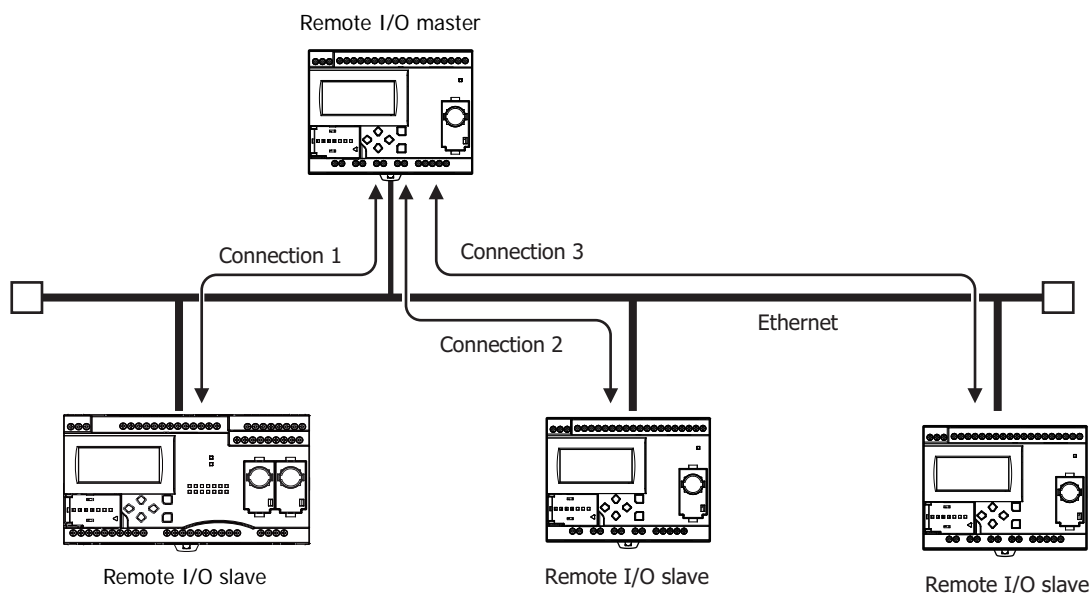

Notes:

- If a communication timeout occurs at a remote I/O slave, all outputs of the remote I/O slave are turned off. Depending on the details of the control on the remote I/O slave side, this may lead to a hazardous situation, so set the master receive timeout to an ample length. If the master receive timeout setting is made long, the time that the remote I/O slave outputs remain on also becomes long when communication is actually lost. Set the master receive timeout to a value suited to each application.
- The SmartAXIS configured as remote I/O master/slave communicates over Ethernet. When other SmartAXIS or other network devices are connected on the same LAN, the I/O refresh timing for the remote I/O slaves is affected by those devices.

Applicable SmartAXIS

FT1A-12	FT1A-24	FT1A-40	FT1A-48
—	X	X	X

12: REMOTE I/O

Remote I/O Master

The SmartAXIS can be used as a remote I/O master by configuring the SmartAXIS as a remote I/O master in WindLDR. The settings can be configured in the Function Area Settings dialog box of WindLDR.

The digital input information from the remote I/O slaves connected with connection 1 through 3 is input to I40 to I75, I80 to I115, and I120 to I155. The analog input information from the remote I/O slaves is stored to D8149 to D8156, D8158 to D8165, and D8167 to D8174.

The output information for Q40 to Q61, Q80 to Q101, and Q120 to Q141 on the remote I/O master is output from the remote I/O slaves connected with connection 1 through 3. For details on data communication between the remote I/O master and the remote I/O slaves, see "Remote I/O Communication Memory Refresh Image" on page 12-3.

Specifications

Item		Description	
Connection 1	Digital inputs	I40 to I75	
	Digital outputs	Q40 to Q61	
	Analog inputs	D8149 (=AI10) to D8156 (=AI17)	
	Remote I/O slave 1 communication error status	D8148	
	Remote I/O slave 1 communication error	M8005	
	Remote host	IP address	000.000.000.000 to 255.255.255.255
		Port number	0 to 65535
Timeout	100 ms to 25,500 ms (100 ms increments)		
Connection 2	Digital inputs	I80 to I115	
	Digital outputs	Q80 to Q101	
	Analog inputs	D8158 (=AI20) to D8165 (=AI27)	
	Remote I/O slave 2 communication error status	D8157	
	Remote I/O slave 2 communication error	M8006	
	Remote host	IP address	000.000.000.000 to 255.255.255.255
		Port number	0 to 65535
Timeout	100 ms to 25,500 ms (100 ms increments)		
Connection 3	Digital inputs	I120 to I155	
	Digital outputs	Q120 to Q141	
	Analog inputs	D8167 (=AI30) to D8174 (=AI37)	
	Remote I/O slave 3 communication error status	D8166	
	Remote I/O slave 3 communication error	M8007	
	Remote host	IP address	000.000.000.000 to 255.255.255.255
		Port number	0 to 65535
Timeout	100 ms to 25,500 ms (100 ms increments)		
Refresh period	Communication processing	Scan asynchronous	
	Data update	Each scan end	

Remote I/O Communication Memory Refresh Image

Data communication between the remote I/O master and the remote I/O slaves is conducted as shown in the diagram below.

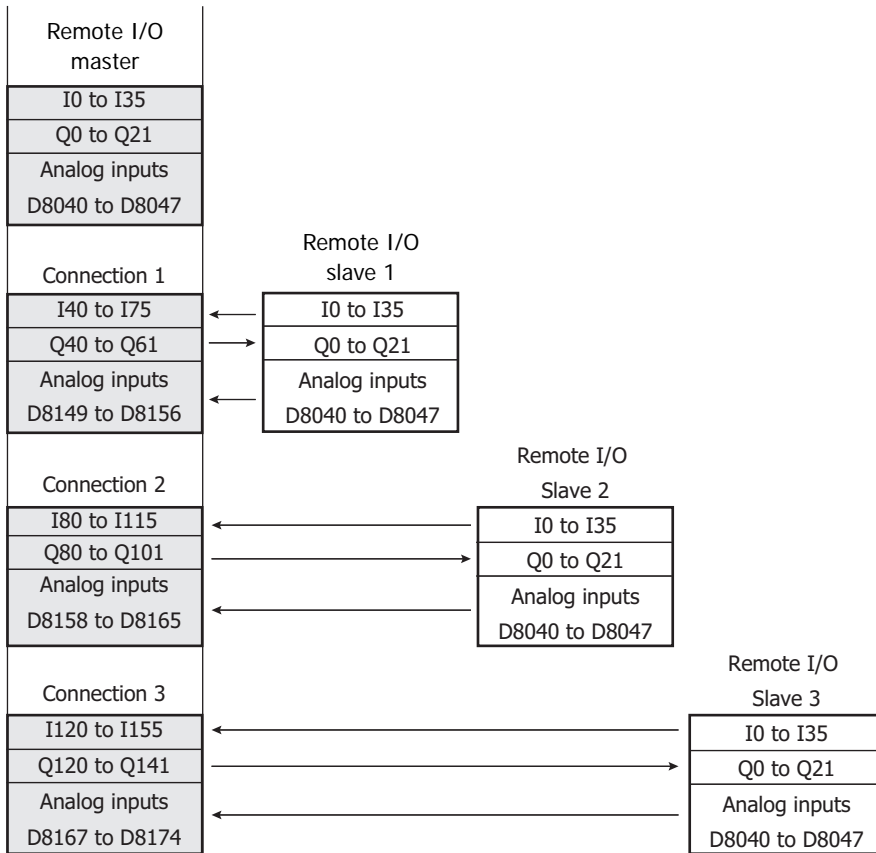

Connection Status with Remote I/O Slaves

The connections status of each remote I/O slave can be confirmed by referring to the special internal relays and special data registers of the SmartAXIS configured as the remote I/O master.

Item	Connection port	Device	Description
Connection status	Connection 1	M8110	Indicates the connection status with the corresponding slave. OFF: Not connected, ON: Connected
	Connection 2	M8111	
	Connection 3	M8112	
IP address of the connected slave	Connection 1	D8110 to D8113	Stores the IP address of the slave.
	Connection 2	D8114 to D8117	
	Connection 3	D8118 to D8121	
Port number of the connected slave	Connection 1	D8130	Stores the connected port number of the slave.
	Connection 2	D8131	
	Connection 3	D8132	

12: REMOTE I/O

Communication Error Information with the Remote I/O Slaves

Communication errors with the remote I/O slaves can be confirmed by referring to M8005 to M8007 (remote I/O slave communication error). The details of the communication error can be confirmed by referring to D8148, D8157, and D8166 (remote I/O slave communication error status).

Item	Device	Description
Remote I/O slave 1 communication error	M8005	ON: Communication error occurs (ON while the error is occurring) OFF: Communicating normally
Remote I/O slave 2 communication error	M8006	
Remote I/O slave 3 communication error	M8007	
Remote I/O slave 1 communication error status	D8148	0: Normal 1: Communication timeout error 2: Connection disconnected 10: Slave output error ^{*1}
Remote I/O slave 2 communication error status	D8157	
Remote I/O slave 3 communication error status	D8166	

*1 The remote I/O master can communicate with the remote I/O slave, but this state indicates a system error has occurred on the remote I/O slave. Check the status of the remote I/O slave.

Remote I/O Communication Timing Chart

Establish connection

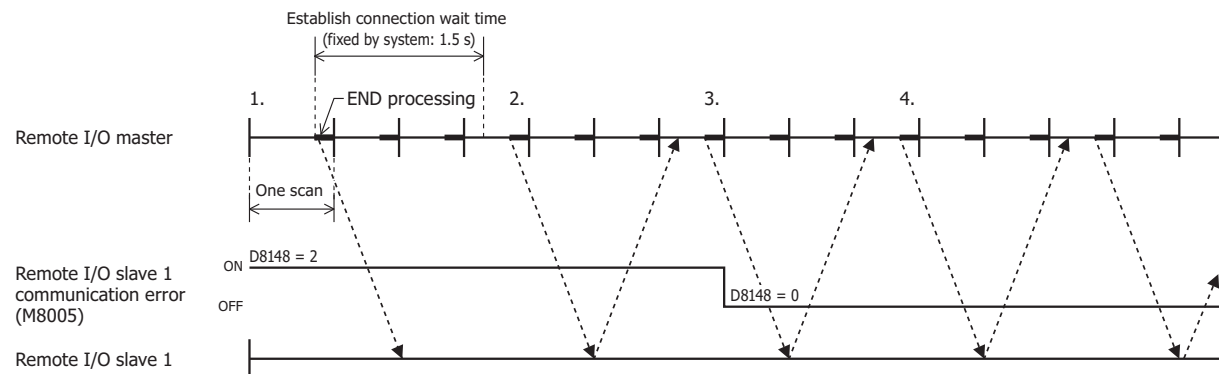

The remote I/O master issues a communication request to the remote I/O slave in the END processing.

1. The remote I/O master's initial state is that the remote slave communication error (M8005 to M8007) is on and the remote slave communication error status (D8148, D8157, D8166) is "2" (connection disconnected).
2. The remote I/O master attempts to establish a connection with remote I/O slave 1, but the connection cannot be established. At the event above, the remote I/O slave 1 communication error (M8005) is kept on, and the remote I/O slave 1 communication status (D8148) is kept as "2" (connection disconnected).
3. When the connection is successfully established afterward, the remote I/O slave 1 communication error (M8005) turns off, and the remote I/O slave 1 communication error status (D8148) also becomes "0" (normal).
4. Communication with remote I/O slave 1 is continued.

Communication timeout

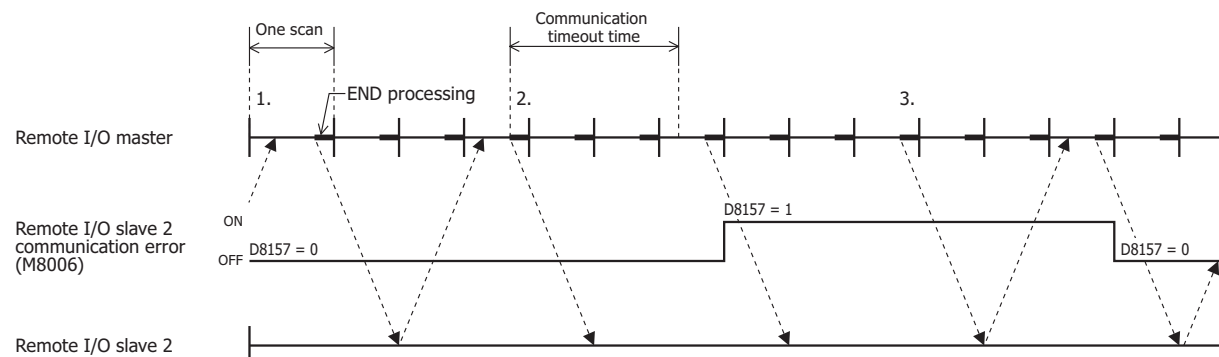

1. While communicating with the remote I/O slave, the remote slave communication error (M8005 to M8007) is off and the remote slave communication error status (D8148, D8157, D8166) is "0" (normal).
2. If the response for a request issued to remote I/O slave 2 takes longer than the communication timeout, the remote I/O slave 2 communication error (M8006) turns on and the remote I/O slave 2 communication error status (D8157) becomes "1" (communication timeout error).
3. When a response from remote I/O slave 2 is returned, the remote I/O slave 2 communication error (M8006) turns off, and the remote I/O slave 2 communication error status (D8157) becomes "0" (normal).

Communication with Multiple Remote I/O Slaves

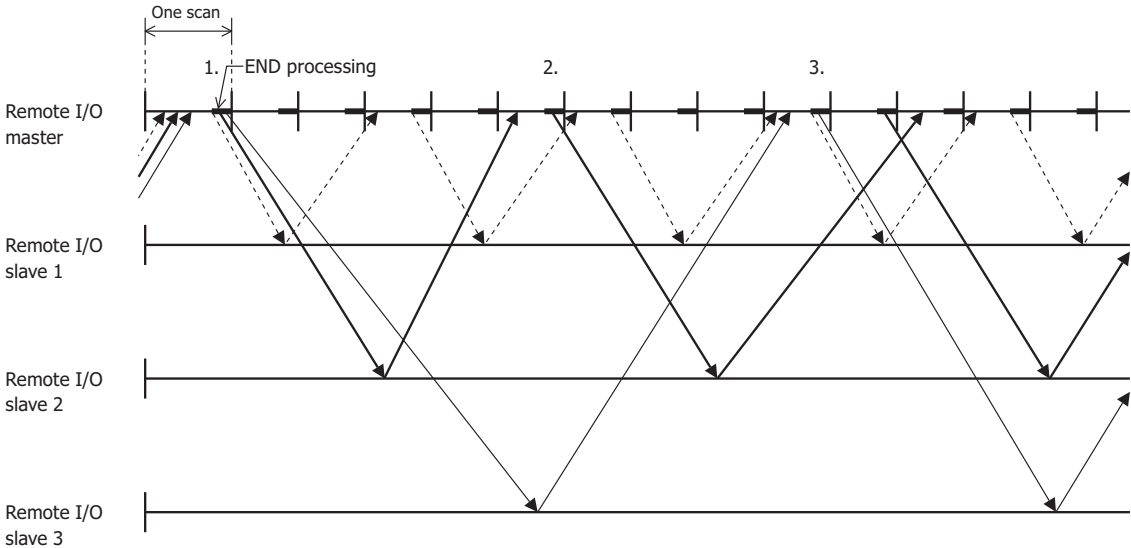

The above timing chart is an example where the communication with remote I/O slave 1 is the fastest and the communication with remote I/O slave 3 is the slowest.

1. The remote I/O master is able to perform remote I/O communication in END processing and it simultaneously issues requests to all remote I/O slaves.
2. The time until the response is returned is affected by the state of the network connecting the remote I/O slaves. Therefore, new requests are only issued for remote I/O slaves that have returned a response.
3. When multiple responses are received in one scan, new requests are issued for all of those simultaneously in END processing.

Note: Remote Communication Speed

The communication speed in remote I/O communication is affected by such factors as the state of the network line and the communication cable. As a reference for communication speed, when performing remote I/O communication using a 100BASE-T compatible cable and switching hub, it takes a minimum of approximately 5 ms after the remote I/O master issues a request until the response from the remote I/O slave is reflected as inputs.

12: REMOTE I/O

Programming WindLDR

To use a SmartAXIS as a remote I/O master, in the WindLDR Function Area Settings, configure the **Remote I/O Master** settings, and then download the user program to the SmartAXIS.

Configuration Procedure

1. From the WindLDR menu bar, select **Configuration > Function Area Settings > Connection Settings**.
The **Function Area Settings** dialog box is displayed.
2. Click **Communication Mode** for the connection to configure, and then select **Remote I/O Master**.
The **Remote I/O Master** dialog box is displayed.

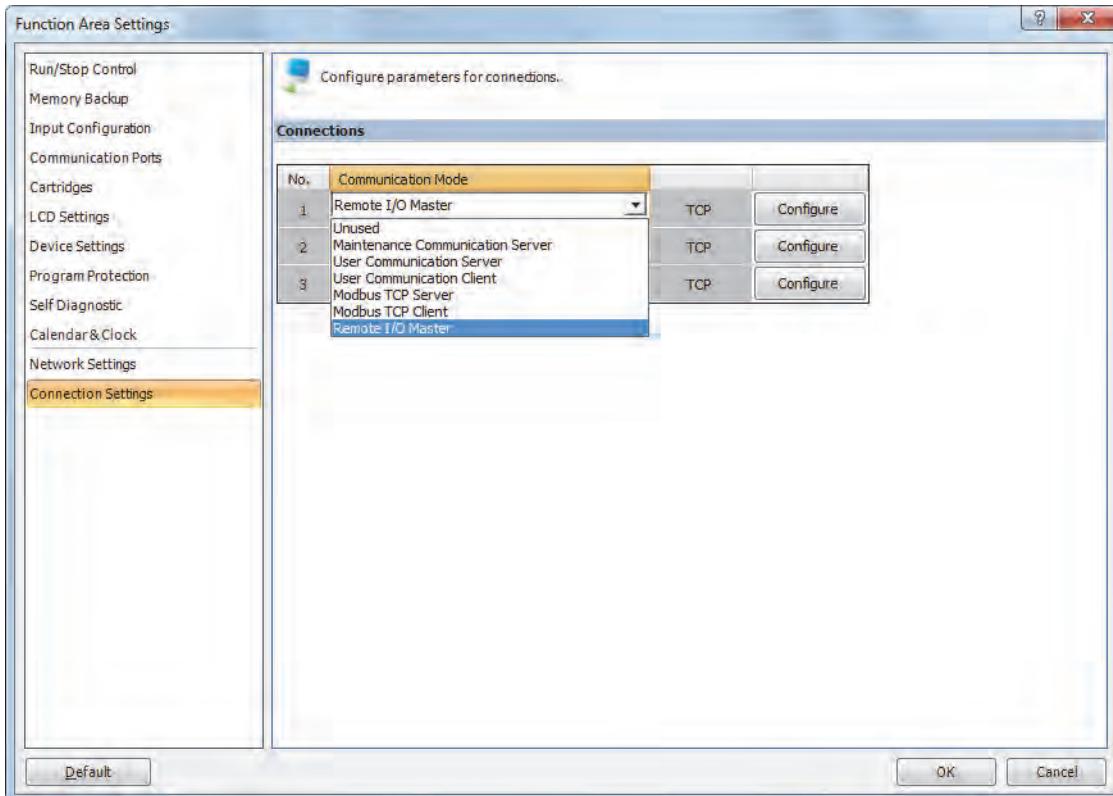

3. Click **Remote Host No.** and select **New Remote Host...**.
The **Remote Host** dialog box is displayed.

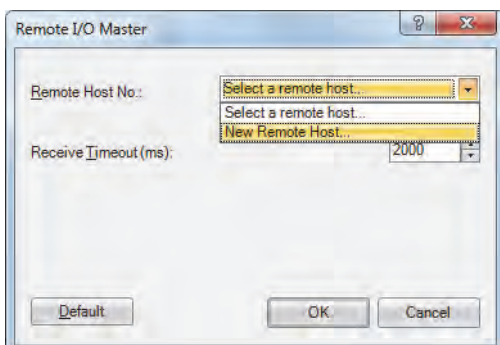

4. Configure the IP address and port number of the remote I/O slave to connect.

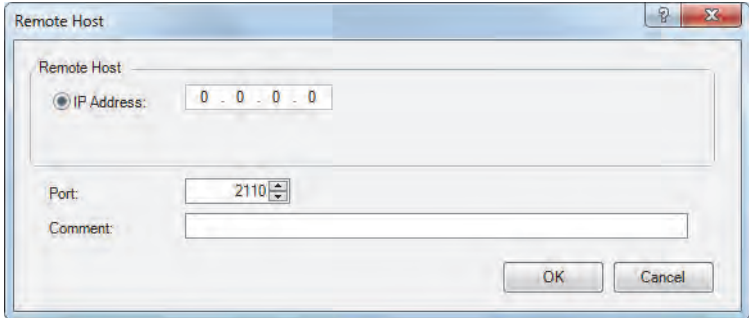

Note: The default port number of the remote I/O slave is 2110.

5. Click **OK**.
When the settings are correctly completed, the details configured in the Remote Host dialog box are displayed in the **Remote Host No.** drop-down list.

6. Configure the receive timeout.

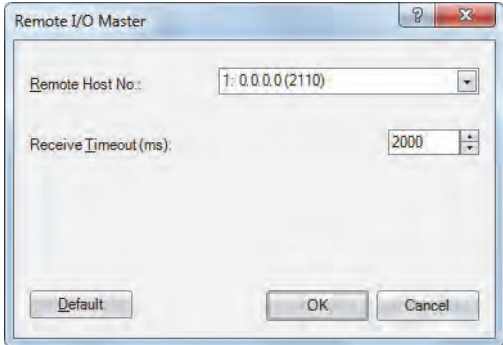

7. Click **OK**.
Configuring the remote I/O master is completed.

12: REMOTE I/O

Remote I/O Slave

The SmartAXIS can be used as a remote I/O slave by configuring the SmartAXIS as a remote I/O slave in WindLDR. The settings can be configured in the Remote I/O Slave Configuration dialog box of WindLDR.

Specifications

Item	Description	
Network settings	Mode	Automatically acquire an IP address/fixed IP address
	IP address	000.000.000.000 to 255.255.255.255
	Subnet mask	000.000.000.000 to 255.255.255.255
	Default gateway	000.000.000.000 to 255.255.255.255
Local Host Port No.	0 to 65535 (default is 2110)	
Master communication timeout (Note)	100 ms to 25,500 ms (100 ms increments)	
Input settings	Analog input settings FT1A-24: 4 points FT1A-40: 6 points FT1A-48: 8 points	
Output settings	None	
Number of simultaneously connectable masters	1	

Note: When communication is lost with the remote I/O master for the configured timeout or longer, all outputs of the remote I/O slave are turned off.

Remote I/O Slave Communication State

The operating status (running/stopped) of the remote I/O slaves cannot be switched. Remote I/O slaves always perform I/O refresh. While remote I/O slaves have no communication with the remote I/O master, they are in "Disconnected" state and all their outputs are off. Once the communication is established with the remote I/O master, they are in "Connected" state and the I/O states start to be exchanged between the master and the slaves.

Status	Description
Connected	The communication between the remote I/O master and slave is established. The digital inputs and analog inputs of the slave are reflected on the master. The outputs of the master are reflected to the slave's outputs.
Disconnected	The remote I/O slave is waiting for the communication from the remote I/O master. The digital inputs and analog inputs of the slave are not reflected on the master. All outputs of the slave are off.

The communication state with the remote I/O master can be checked with the LED on the SmartAXIS Lite and with the LCD on the SmartAXIS Pro.

■ Lite

The communication state is reflected in the power/run status LED.

Status	Description
Connected	The power/run status LED is on.
Disconnected	The power/run status LED is flashing.

■ Pro

The communication state is displayed on the standard screen and the status monitor screen. For how to check the communication state on the status screen, see "Monitoring the Remote I/O Slave Status" on page 12-9.

Standard screen

Connected

Remote I/O Slave
Connected

Disconnected

Remote I/O Slave
Disconnected

Remote I/O Slave HMI Function

This section describes the menu screen when the SmartAXIS Pro is configured as a remote I/O slave.

For the button operations on the menu screen, see Chapter 6 "HMI Function".

Standard Screen

This screen displays content according to the communication state with the remote I/O master.

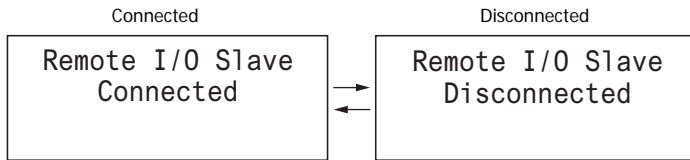

System menu

The menu items displayed when the SmartAXIS is configured as a remote I/O slave.

- Configurations
- Device Monitor*1
- Status Monitor
- Error Status

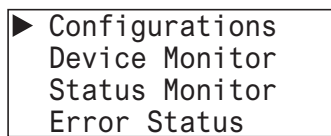

*1 The remote I/O slave device monitor is read-only. The device values cannot be modified.

Monitoring the Remote I/O Slave Status

You can check the system software version and the communication cycle of the remote I/O slave.

1. On the standard screen, press the **ESC** (ESC) + **OK** (OK) buttons.

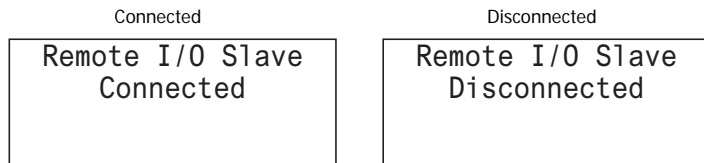

The system menu is displayed.

2. Select **Status Monitor** with the **▲** (up) and **▼** (down) buttons and press the **OK** (OK) button.

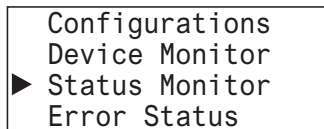

3. The system version is displayed. Press the **▼** (down) button.

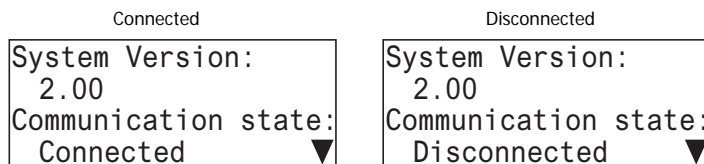

The communication cycle is displayed.

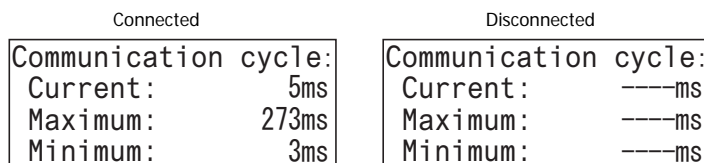

- Current: The current communication cycle with the remote I/O master.
- Maximum: The maximum communication cycle from when the connection with the remote I/O master was established until the present.
- Minimum: The minimum communication cycle from when the connection with the remote I/O master was established until the present.

12: REMOTE I/O

Remote I/O Slave Operation and Restrictions

The remote I/O slave outputs conform to the remote I/O master outputs. Therefore, the following restrictions are applied when the SmartAXIS operates as a remote I/O slave.

Special internal relays	All Outputs OFF (M8002)	Cannot be used.
	Maintain Outputs While CPU Stopped (M8025)	Cannot be used.
Communication settings	Serial communication port	The communication mode is always "Maintenance Communication". The communication settings are fixed as the following settings. Baud rate: 115,200 bps Data length: 7 bits Parity: Even Stop bits: 1 bit
	Ethernet Communication	Cannot be used except for remote I/O communication.
Maintenance Communication	Access to devices	Output relay (Q) on/off state cannot be changed. Other devices can be read and written to normally.
	Forced I/O function	Cannot be used.
	Data File Manager	Cannot be used.

Programming WindLDR

To use a SmartAXIS as a remote I/O slave, connect the SmartAXIS to the computer and configure it as a remote I/O slave with WindLDR.

Notes:

The following restrictions apply when the SmartAXIS is configured as a remote I/O slave.

- The SmartAXIS only operates as remote I/O, functions other than the inputs and outputs are disabled.
- The user program originally entered into the SmartAXIS is deleted.
- No other settings except the remote I/O slave settings can be configured.

Configuration Procedure

1. Select **Configuration > Remote I/O > Configure Slave**.

The **Remote I/O Slave Configuration** dialog box is displayed.

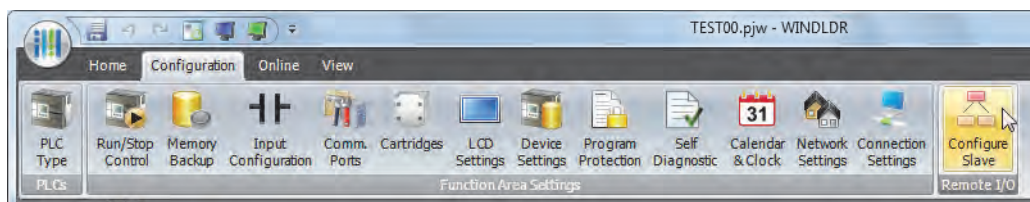

2. Click **PLC Type** and select the PLC type of the connected SmartAXIS to configure.

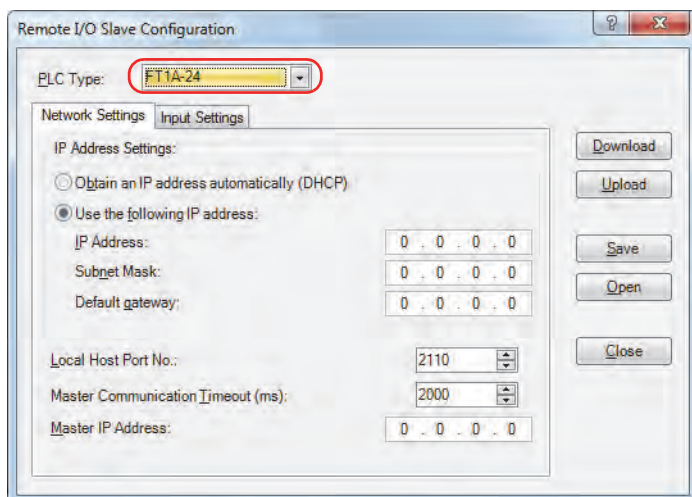

3. Click the **Network Settings** tab and configure the IP address, subnet mask, default gateway, local host port number, and master communication timeout for the remote I/O slave.

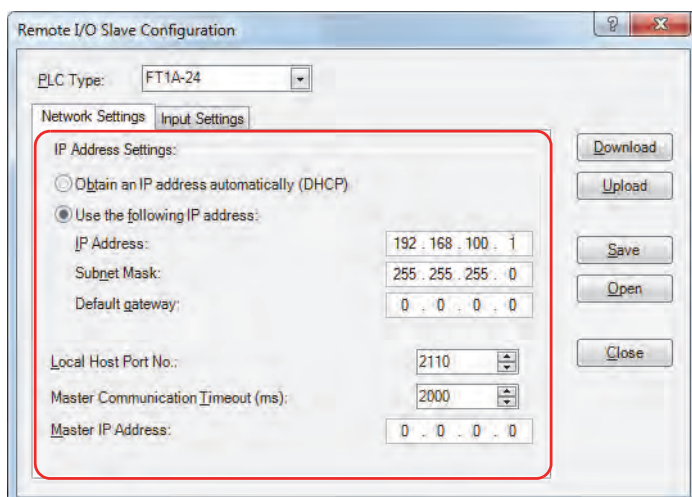

12: REMOTE I/O

Note: When automatically acquiring an IP address using DHCP, the same IP address may not be assigned each time depending on the DHCP server settings and the system configuration on the network where the SmartAXIS is operating. (Example: When using DHCP with two SmartAXIS units and automatically acquiring the IP addresses, the IP addresses for the two units may be swapped.) When the SmartAXIS is incorporated in a system configuration where it is a communication target, we recommend setting a fixed IP address, subnet mask, and default gateway.

4. In **Master IP Address**, enter the IP address of the remote I/O master to connect.

The screenshot shows the 'Remote I/O Slave Configuration' dialog box with the 'Network Settings' tab selected. The 'PLC Type' is set to 'FT1A-24'. Under 'IP Address Settings', the radio button 'Use the following IP address:' is selected. The IP Address is '192.168.100.1', Subnet Mask is '255.255.255.0', and Default gateway is '0.0.0.0'. The 'Local Host Port No.' is '2110' and 'Master Communication Timeout (ms)' is '2000'. The 'Master IP Address' field, containing '0.0.0.0', is highlighted with a red rectangular box.

5. Click the **Inputs Settings** tab, and then configure the settings for the analog and digital inputs. For details on the settings, see "Analog Input" on page 5-39.

The screenshot shows the 'Remote I/O Slave Configuration' dialog box with the 'Input Settings' tab selected. The 'Analog/Digital Inputs' section is highlighted with a red rectangular box. It contains a table with the following data:

Address	Type	Filter (times)
I0014	Digital	
I0015	Digital	
I0016	Digital	
I0017	Digital	

Note: For the remote I/O slave, the input filter's set time is fixed to 3 ms. For details on the input filter function, see Chapter 5 "Special Functions" - "Input Filter" on page 5-38.

6. Click **Download** to download the remote I/O slave settings to the connected SmartAXIS. Configuring the remote I/O slave is completed.

Notes:

The remote I/O slave settings downloaded to the SmartAXIS can be uploaded to the Remote I/O Slave Configuration dialog box. However, the following points should be taken into consideration:

- If the connected SmartAXIS is not configured as a remote I/O slave, the remote I/O slave settings cannot be uploaded.
- The existing settings on the dialog box are overwritten.

Saving and Reusing Remote I/O Slave Settings

Remote I/O slave settings configured in the dialog box are lost when the dialog box is closed. Remote I/O slave settings configured in the Remote I/O Slave Configuration dialog box can be reused by saving them as a configuration file (*.frs).

Note: No other information except the remote I/O slave settings are stored in the configuration file (*.frs) saved using the **Remote I/O Slave Configuration** dialog box.

Saving Remote I/O Slave Settings

Operation Procedure

- 1. In the **Remote I/O Slave Configuration** dialog box, click **Save**. The **Save As** dialog box is displayed.

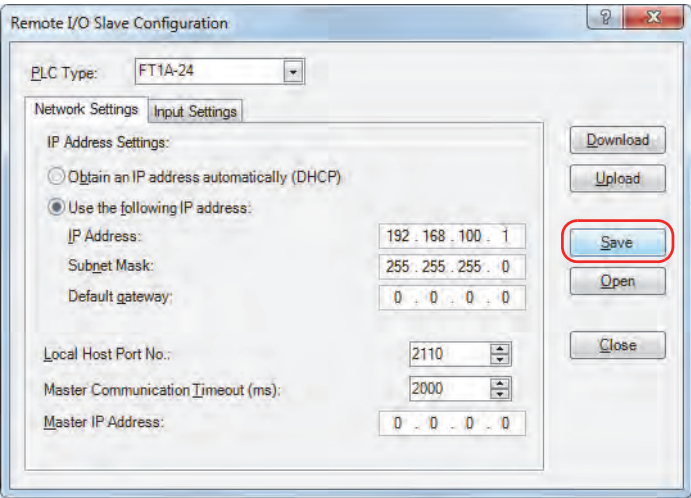

- 2. Specify the location to save to and enter the file name.

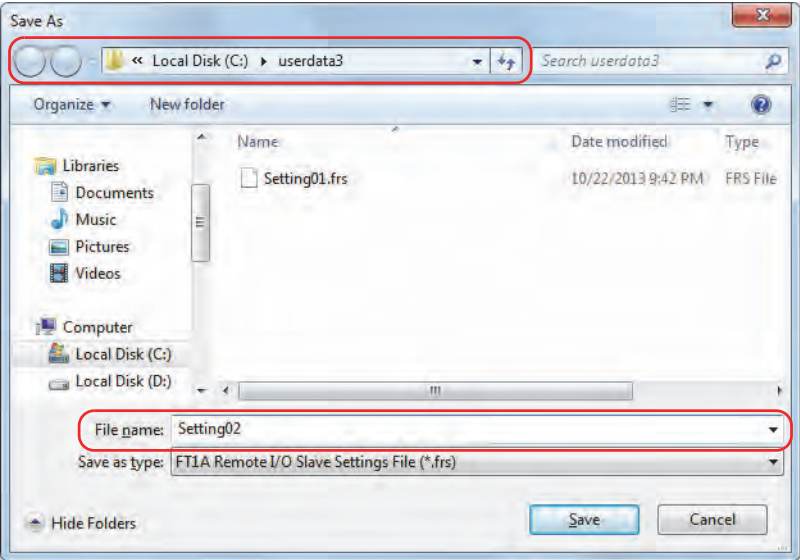

- 3. Click **Save**. A configuration file (*.frs) containing the remote I/O slave settings is created in the specified location.

Using Saved Remote I/O Slave Settings

Operation procedure

1. In the **Remote I/O Slave Configuration** dialog box, click **Open**.
The **Open** dialog box is displayed.

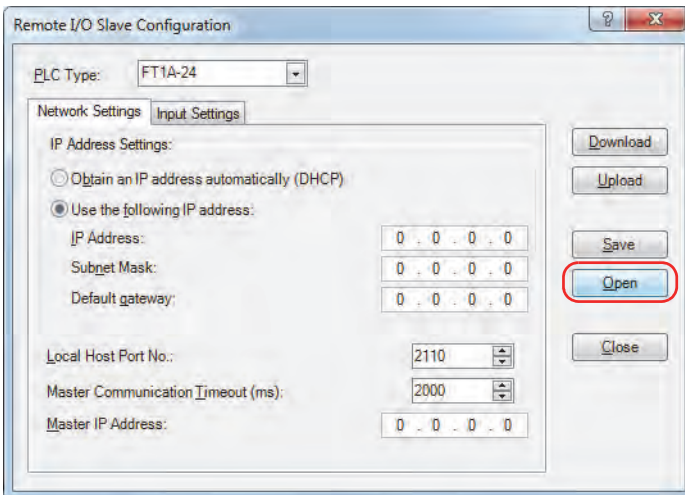

2. Select the configuration file (*.frs) to use and click **Open**.
The remote I/O slave settings are loaded.

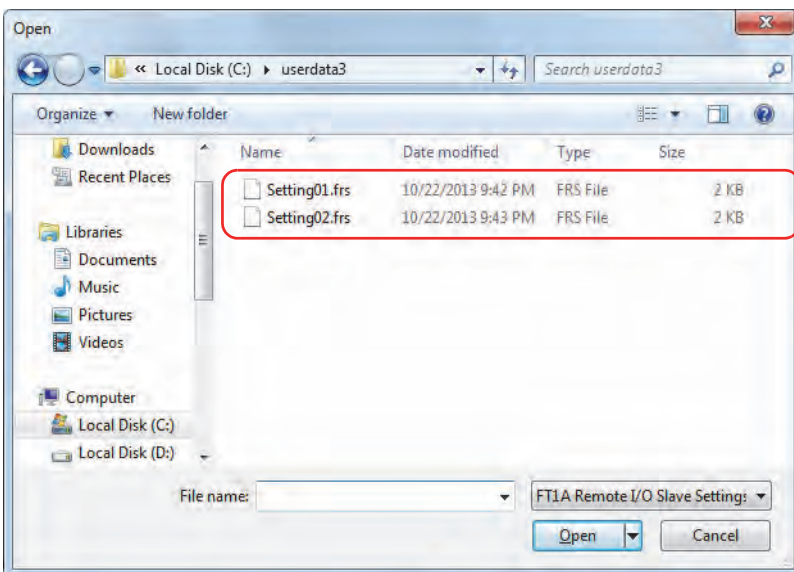

Notes:

- When the remote I/O slave settings are read, the existing settings in the dialog box are overwritten.
- If you specify an invalid file, an error message is displayed and the remote I/O slave settings are not loaded.

13:SCRIPTS

Introduction

A script is a function for programming complicated processing with conditional branch, logical operations, arithmetic operations, and functions as text.

The programmed scripts can be executed in a ladder program or an FBD program. When the programming language is ladder, scripts are executed with the SCRPT instruction. For details, see "SmartAXIS Ladder Programming Manual" - Chapter 27 "Script". When the programming language is FBD, scripts are executed with the SCRPT FB. For details, see "SmartAXIS FBD Programming Manual" - Chapter 17 "The script FB".

For example, the logical AND operation is written as follows.

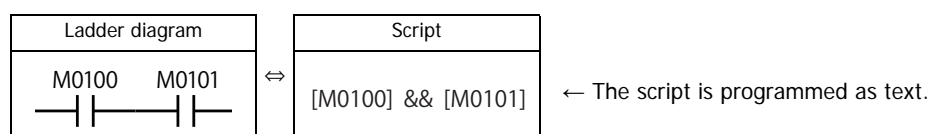

■ Script Programming and Management

Scripts are programmed using the Script Editor dialog box in WindLDR and managed with the Script Manager dialog box.

Notes:

- In Script Editor, you can program scripts by selecting conditional expressions, operators, and functions from a list, and you can also check them for errors. The scripts can also be exported as text files, so they can be edited using a text editor such as Notepad. If you save an edited script as a text file, it can be imported into Script Editor.
For details, see "Script Editor" on page 13-6.
- In Script Manager, you can manage the scripts as a group by adding scripts created in Script Editor or deleting them. For details, see "Script Manager" on page 13-5.

Script Data Type

The data type for the range of data that will be handled in the script must be configured by taking into consideration the details of the processing in the script including the maximum and minimum values of data that will be handled and whether negative numbers and real numbers are required.

Note: The data type is configured in Script Editor. For how to configure it, see "Script Editor" on page 13-6.

Data Types

The following five data types can be processed in a script. For details about data types in ladder, see Chapter 4 "Instructions Reference" - "Data Types for Advanced Instructions" in the "SmartAXIS Ladder Programming Manual". For details about data types in FBD, see Chapter 4 "FB Reference" - "Data types" in the "SmartAXIS FBD Programming Manual".

Data type		Used data registers	Processable unit	Data range
Abbreviation	Name			
W	Word	1	Unsigned 16 bits	0 to 65,535
I	Integer	1	Signed 15 bits	-32,768 to 32,767
D	Double word	2	Unsigned 32 bits	0 to 4,294,967,295
L	Long	2	Signed 31 bits	-2,147,483,648 to 2,147,483,647
F	Float	2	Signed 32 bits	-3.402823E+38 to -1.175495E-38 0 1.175495E-38 to 3.402823E+38

Note: Some functions cannot be used if the data type is different. Check the function in the notation list.

See "Programming Scripts" on page 13-10.

13: SCRIPTS

Device List

This section shows the devices that can be used in Script Editor and the device notation.

This section describes available devices and its notation that can be used in the Script Editor dialog box.

Note: The device ranges differ depending on each SmartAXIS. Specify the devices within the device range of the selected SmartAXIS. For device ranges, see "Device Addresses" on page 7-1.

	Device	Notation in Script Editor
Bit device	I (Inputs)	I000 to I155
	Q (Outputs)	Q000 to Q141
	R (Shift registers)	R000 to R127
	M (Internal relays)	M0000 to M1277, M8000 to M8177
	C (Counter contacts)	C000 to C199
	T (Timer contacts)	T000 to T199
	D (Data register bits)	D0000.0 ... D0000.15 to D1999.0 ... D1999.15, D8000.0 ... D8000.15 to D8199.0 ... D8199.15
Word device	D (Data registers)	D0000 to D1999, D8000 to D8199
	TC (Timer current values)	TC000 to TC199
	TP (Timer preset values)	TP000 to TP199
	CC (Counter current values)	CC000 to CC199
	CP (Counter preset values)	CP000 to CP199

Calculations in which both bit and word devices are used are not allowed.

Bit devices are always processed as bits, and values of those devices are 0 (OFF) or 1 (ON).

Applicable SmartAXIS

FT1A-12	FT1A-24	FT1A-40	FT1A-48
X	X	X	X

Script Programming and Management

Script Registration Procedure

This section describes the procedure to create and register a script. The registered script can be executed by specifying the script ID in the SCRPT instruction/FB.

1. On the **Project Window**, double-click **Script Manager**.

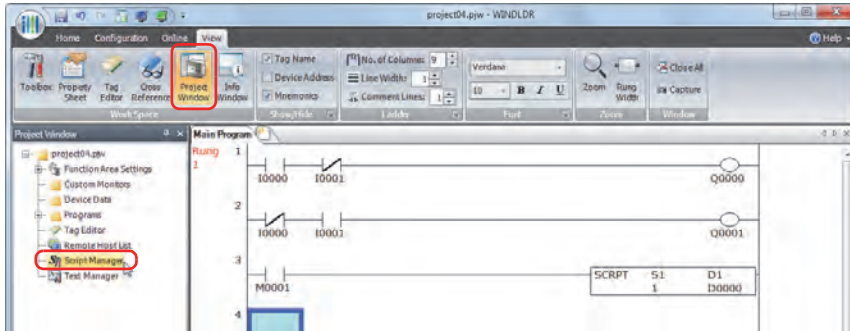

Script Manager dialog box opens.

2. Click **Add**.

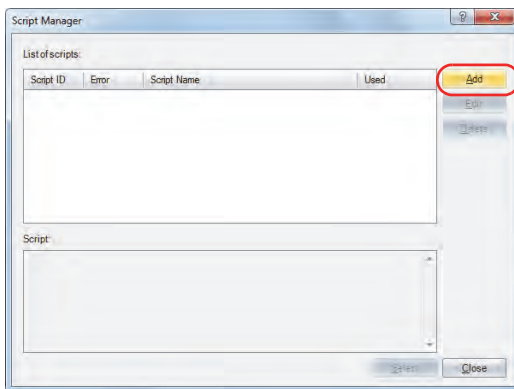

Script Editor dialog box opens.

3. Specify **Script ID**.

When creating a new script, enter the script ID (1 to 255).

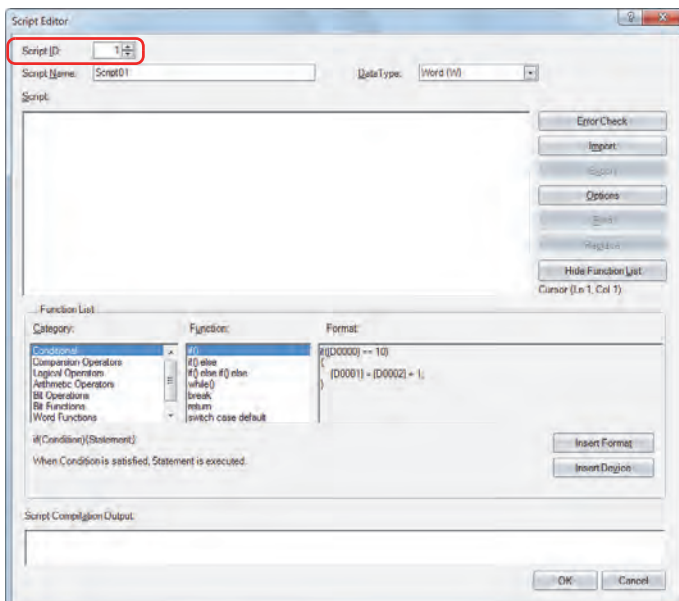

13: SCRIPTS

4. Enter Script Name.

The script name can be entered up to 40 single-byte alphanumeric characters.

5. Select Data Type.

Note: The script is executed with the selected data type.

6. In Script, write the program.

Note: To create a script using the sample codes provided by WindLDR, under **Function list**, select **Category** and **Function**, and then click **Insert Format**. The sample code displayed in **Format** is inserted at the cursor position in **Script**.

7. After you finish creating the script, click OK.

You are returned to the Script Manager dialog box and the created script is displayed in **Script list**.

8. Click Close.

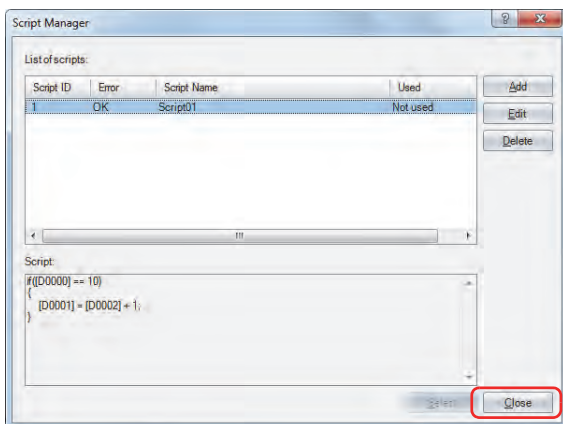

A save confirmation message is displayed.

9. Click OK.

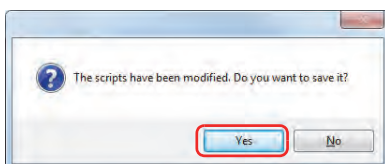

The script is saved and the Script Manager dialog box is closed.

Note: If you click **No**, the script is not saved and the Script Manager dialog box is closed.

Script Manager

In the Script Manager dialog box, you can add scripts created in the Script Editor dialog box or delete registered scripts.

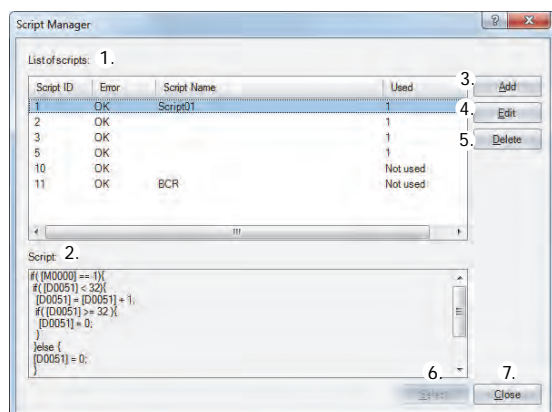

1. List of scripts

Shows the list of registered scripts.

Script ID: Shows the script ID of the registered scripts (1 to 255).

Error: Shows **OK** if the registered script has no errors. Shows **NG** if there are any errors.

Script name: Shows the name of the registered scripts.

Used: Shows whether or not the registered scripts are used in this project.

2. Script

Shows the contents of the script selected in the Script list.

3. Add

Click this button to display the Script Editor dialog box in order to create and add a script.

For details, see "Script Editor" on page 13-6.

4. Edit

Click this button to open the Script Editor dialog box in order to edit the script selected in the **Script List**.

For details, see "Script Editor" on page 13-6.

5. Delete

Click this button to delete the script selected in the **Script List**.

6. Select

Click this button to close the Script Manager dialog box and set the script ID of the script selected in the **Script List** to the editing dialog box.

7. Close

Click this button to close Script Manager.

Note: If you click **Close** when the script list was modified, a save confirmation message is displayed. Click **Yes** on the confirmation message to save the changes. Click **No** to discard the changes and close Script Manager.

Script Editor

Script Editor is where you create new scripts and edit the scripts selected in Script Manager.

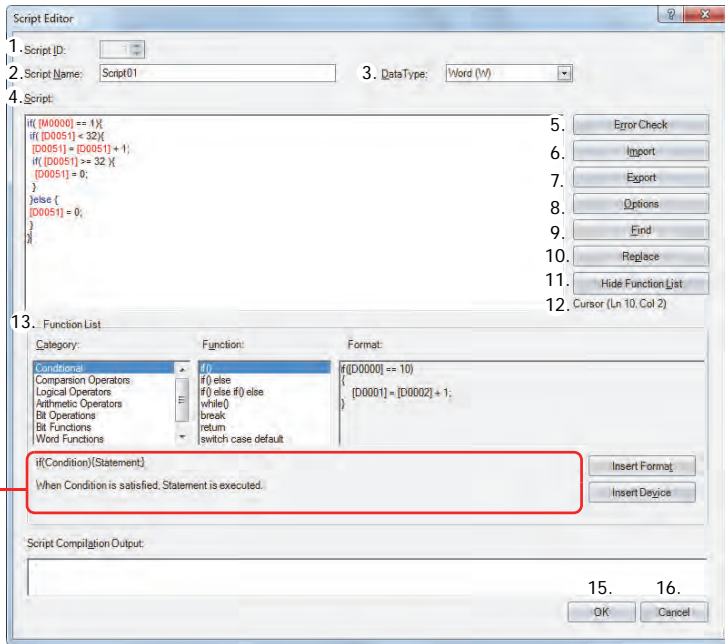

(Description)

1. Script ID

When creating a new script, enter the script ID (1 to 255). When editing an existing script, this shows the script ID that was set.

2. Script Name

Enter the script name. The script name can be entered up to 40 characters.

3. Data Type

Select the data type to process in the script. For details about the data types, see "Script Data Type" on page 13-1.

4. Script

Enter the script.

The restrictions for one script are a maximum of 240 characters per line and a maximum of 1024 lines per script.

5. Error Check

Click this button to check errors in the current script.

6. Import

Click this button to display the Open dialog box so you can import a script program.

If you select a script that was saved (exported) as a text file (*.txt) and click **Open**, the selected script is inserted at the current cursor position in the current script.

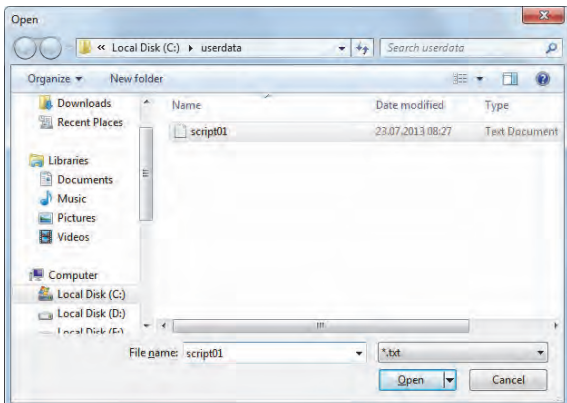

7. Export

Click this button to display the Save As dialog box so you can export the script program.

If you select the location to save the script, enter a file name, and click **Save**, the current script is saved as a text file (*.txt). The saved script can be inserted with **Import**.

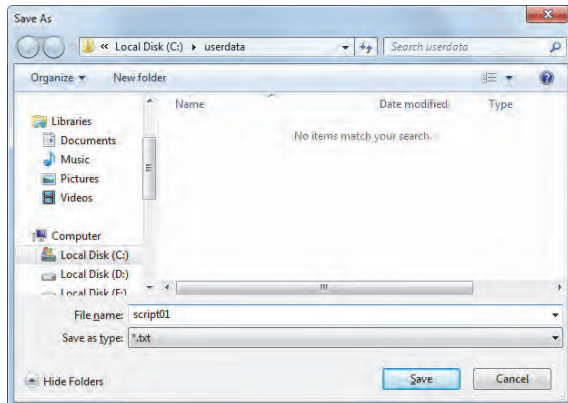

8. Options

Click this button to display the Options dialog box.

In the Options dialog box, you can configure the font for the text used in the Script text box, the colors, the tab indents, and other settings. For details, see "Options Dialog Box" on page 13-8.

9. Find

Click this button to display the Find dialog box.

You can search the entered text in the script.

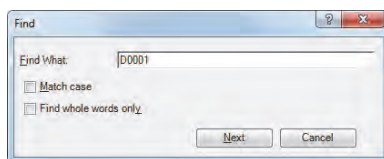

Note: If you first select an area in the script and then click **Find**, you can search only in the selected area.

10. Replace

Click this button to display the Replace dialog box.

Enter the text to search in the script in **Find what** and enter the text to replace it with in **Replace with**.

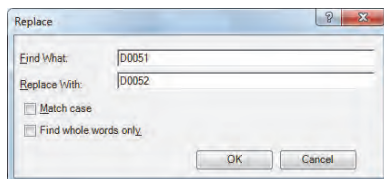

Notes:

- This is an effective tool when replacing device addresses.
- If you first select an area in the script and then click **Replace**, you can search and replace text only in the selected area.

11. Show/Hide Function List

This button shows and hides **Function List** and **Output**.

Note: Click and drag the bottom right corner of Script Editor and you can change the size of the box for editing scripts. By hiding **Function List** and **Output**, you can increase the size of the script editing area (text box) and make it easier to edit the script.

12. Cursor

Shows the current cursor position in the **Script** text box as the line number and the column number.

13. Function List

Category:	Shows the function category list.
Function:	Shows the list of functions in the selected category.
Format:	Shows a programming example of the selected function.
Description:	Shows a description of the selected function.
Insert Format:	Click this button to insert the content displayed in Format at the cursor position.
Insert Device:	Click this button to open the Tag Editor dialog box. Specify a device address and click OK to insert the specified device address at the cursor position.

14. Script Compilation Output

Shows the details of errors when there are errors in the script in the error check.

If you double-click a comment displayed in **Script Compilation Output**, the section that corresponds to the error is highlighted in the **Script**.

Note: Depending on the error, the error may exist on a line that differs from the line displayed in the output, or it may show multiple errors.

15. OK

Click this button to perform the error check on the current script, and then return to Script Manager after the script is saved.

Note: If there are any errors in the current script the save confirmation message is displayed. Scripts that contain errors can be saved.

16. Cancel

Click this button to return to Script Manager without saving the current script.

Options Dialog Box

This dialog box allows you to specify **Font**, **Size**, **Tab indent**, and **Colors** used in the Script Editor **Script** text box.

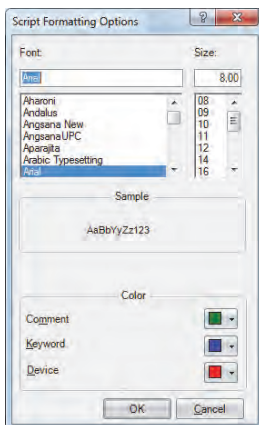

■Font

Enter or select the font name for text displayed in **Script**.

■Size

Enter or select the size (pixels) of text displayed in **Script**.

■Sample

Shows a sample of text that will be displayed in the **Script** text box with the character font and the character size specified by **Font** and **Size**.

■ Colors

Shows the colors for **Comment**, **Keyword**, and **Device**.
Click the colored buttons to display the Color dialog box.

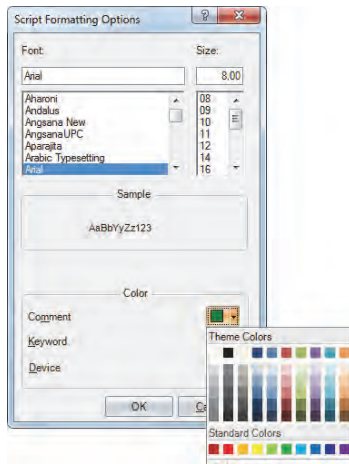

Characters that are not comments, keywords, or devices are all shown in black.

Programming Scripts

Format List

This section describes the notation for control statements, operators, functions, and other elements, and it also describes their operation.

Except for comments, enter everything as single-byte characters. For specific programming examples, see "Script Programming Examples" on page 13-16.

Control Statements

Conditional expressions are written here as (Cond. expr.), (Cond. expr. 1), (Cond. expr. 2).

Executable lines are written as (Exe. line), (Exe. line 1), (Exe. line 2) and so on.

■ Conditional branch

	Format	Description
	<code>if (Cond. expr.) { (Exe. line); }</code>	Execution line is executed if the conditional expression is satisfied.
if else else if	<code>if (Cond. expr.) { (Exe. line 1); } else { (Exe. line 2); }</code>	Execution line 1 is executed if the conditional expression is satisfied. Execution line 2 is executed if it is not satisfied.
	<code>if (Cond. expr. 1) { (Exe. line 1); } else if (Cond. expr. 2) { (Exe. line 2); } else { (Exe. line 3); }</code>	Execution line 1 is executed if the conditional expression 1 is satisfied. Conditional expression 2 is evaluated if conditional expression 1 is not satisfied, and execution line 2 is executed if conditional expression 2 is satisfied. Execution line 3 is executed if conditional expression 2 is not satisfied too.
switch case default	<code>switch (Cond. expr.) { case constant 1: (Exe. line 1); break; case constant 2: (Exe. line 2); break; default: (Exe. line 3); break; }</code>	Execution line 1 is executed if the value of conditional expression matches constant 1. Execution line 2 is executed if the value of conditional expression matches constant 2. Execution line 3 is executed if the value of conditional expression does not match constant 1 nor constant 2.

■ Repeat

	Format	Description
while	<code>while (Cond. expr.) { (Exe. line); }</code>	Execution line is repeatedly executed while the conditional expression is satisfied. The execution will go into an infinite loop when the conditional expression is always satisfied, so do not use fixed values or devices that do not change as the conditional expression.

■ Halt and exit

	Format	Description
break	<pre>while ((Cond.expr.1) { if ((Cond.expr.2) { (Exe.line 1); break; } (Exe.line 2); } (Exe.line 3);</pre>	<p>Process will be as follows while the conditional expression 1 is satisfied. Execution line 2 is continuously executed while the conditional expression 2 is not satisfied.</p> <p>Once the conditional expression 2 is satisfied, the execution goes out of the loop by break (not executing execution line 2), and execution line 3 is executed.</p>
break	<pre>switch ((Cond.expr.) { case constant 1: (Exe.line 1); break; case constant 2: (Exe.line 2); break; } (Exe.line 3);</pre>	<p>When the conditional expression matches the constant 1, execution line 1 is executed and the switch execution is terminated by break. Evaluation for constant 2 is not executed, and the execution moves to execution line 3.</p>
return	return;	Script will exit and the next instruction/FB in the user program is executed.

Operator

Device, constant, and temporary device are described as \boxed{a} , \boxed{b} here, and expressions are described as (Expr.) , (Expr. 1) , (Expr. 2) .

■ Relational operator

Operator	Format	Description
==	$\boxed{a} == \boxed{b}$	Compares if \boxed{a} is equal to \boxed{b} .
!=	$\boxed{a} != \boxed{b}$	Compares if \boxed{a} is not equal to \boxed{b} .
<	$\boxed{a} < \boxed{b}$	Compares if \boxed{a} is less than \boxed{b} .
<=	$\boxed{a} <= \boxed{b}$	Compares if \boxed{a} is less than or equal to \boxed{b} .
>	$\boxed{a} > \boxed{b}$	Compares if \boxed{a} is greater than \boxed{b} .
>=	$\boxed{a} >= \boxed{b}$	Compares if \boxed{a} is greater than or equal to \boxed{b} .

■ Logical operator

Operator	Format	Description
&&	$\text{(Expr. 1)} \ \&\& \ \text{(Expr. 2)}$	Calculates the logical product (AND) of (Expr. 1) and (Expr. 2) .
	$\text{(Expr. 1)} \ \ \text{(Expr. 2)}$	Calculates the logical sum (OR) of (Expr. 1) and (Expr. 2) .
!	$! \ \text{(Expr.)}$	Inverse the logic of (Expr.) .

■ Arithmetic operator

Operator	Format	Description
+	$\boxed{a} + \boxed{b}$	Adds \boxed{a} and \boxed{b} .
-	$\boxed{a} - \boxed{b}$	Subtracts \boxed{b} from \boxed{a} .
*	$\boxed{a} * \boxed{b}$	Multiplies \boxed{a} and \boxed{b} .
/	\boxed{a} / \boxed{b}	Divides \boxed{a} by \boxed{b} .
%	$\boxed{a} \% \boxed{b}$	Calculates remainder after dividing \boxed{a} by \boxed{b} .

13: SCRIPTS

■ Bit operator

Operator	Format	Description
&	<code>[a] & [b]</code>	Calculates the logical product (AND) of each bit of <code>[a]</code> and <code>[b]</code> .
	<code>[a] [b]</code>	Calculates the logical sum (OR) of each bit of <code>[a]</code> and <code>[b]</code> .
^	<code>[a] ^ [b]</code>	Calculates the exclusive logical sum (XOR) of each bit of <code>[a]</code> and <code>[b]</code> .
~	<code>~[a]</code>	Inverse the logic of each bits of <code>[a]</code> . For word devices and fixed values, 0 will be 65,535, and 65,535 will be 0. For bit device, 0 will be 1, and 1 will be 0.
<<	<code>[a] << [b]</code>	Shifts each bit of <code>[a]</code> to the left for <code>[b]</code> bit(s).
>>	<code>[a] >> [b]</code>	Shifts each bit of <code>[a]</code> to the right for <code>[b]</code> bit(s).

Function

Device, constant, and temporary device are described as `[a]`, `[b]`, `[c]`, `[d]`... here.

■ Bit function

Function	Format	Description
Bit set	<code>SET([a]);</code>	Turns bit device <code>[a]</code> to 1. This is the same result as <code>[a] = 1;</code> .
Bit reset	<code>RST([a]);</code>	Turns bit device <code>[a]</code> to 0. This is the same result as <code>[a] = 0;</code> .
Bit reverse	<code>REV([a]);</code>	Reverses the 1 and 0 of bit device <code>[a]</code> . This is the same result as <code>[a] = ~[a];</code> .

■ Word function

Arithmetic operation

Function	Format	Description
Maximum value	<code>MAX([a], [b], [c])</code>	Maximum value out of <code>[a]</code> , <code>[b]</code> , <code>[c]</code> is returned. <ul style="list-style-type: none"> This can be used for all data types. Up to 15 arguments can be defined.
Minimum value	<code>MIN([a], [b], [c])</code>	Minimum value out of <code>[a]</code> , <code>[b]</code> , <code>[c]</code> is returned. <ul style="list-style-type: none"> This can be used for all data types. Up to 15 arguments can be defined.
Exponential function	<code>EXP([a])</code>	Exponential function of <code>[a]</code> is returned. <ul style="list-style-type: none"> This can only be used for data type F (float).
Natural logarithm (base: e)	<code>LOGE([a])</code>	Natural logarithm (base is e) for <code>[a]</code> is returned. <ul style="list-style-type: none"> This can only be used for data type F (float). Set a value larger than 0 for argument.
Common logarithm (Base: 10)	<code>LOG10([a])</code>	Common logarithm (base is 10) for <code>[a]</code> is returned. <ul style="list-style-type: none"> This can only be used for data type F (float). Set a value larger than 0 for argument.
Exponentiation	<code>POW([a], [b])</code>	<code>[a]</code> to the <code>[b]</code> power is returned. <ul style="list-style-type: none"> This can only be used for data type F (float).
Square root	<code>ROOT([a])</code>	Square root of <code>[a]</code> is returned. <ul style="list-style-type: none"> This can only be used for data type F (float).
Sine	<code>SIN([a])</code>	Sine of <code>[a]</code> (-1 to +1) is returned. Specify arbitrary formula to represent angle (units in radian) for argument <code>[a]</code> . <ul style="list-style-type: none"> This can only be used for data type F (float).
Cosine	<code>COS([a])</code>	Cosine of <code>[a]</code> (-1 to +1) is returned. Specify arbitrary formula to represent angle (units in radian) for argument <code>[a]</code> . <ul style="list-style-type: none"> This can only be used for data type F (float).
Tangent	<code>TAN([a])</code>	Tangent of <code>[a]</code> (-1 to +1) is returned. Specify arbitrary formula to represent angle (units in radian) for argument <code>[a]</code> . <ul style="list-style-type: none"> This can only be used for data type F (float).

Function	Format	Description
Arcsine	ASIN(<input type="text" value="a"/>)	Arcsine of <input type="text" value="a"/> (-1 to +1) in radian value ($-\pi/2$ to $+\pi/2$) is returned. Specify arbitrary formula for argument <input type="text" value="a"/> . <ul style="list-style-type: none"> This can only be used for data type F (float).
Arccosine	ACOS(<input type="text" value="a"/>)	Arccosine of <input type="text" value="a"/> (-1 to +1) in radian value (0 to π) is returned. Specify arbitrary formula for argument <input type="text" value="a"/> . <ul style="list-style-type: none"> This can only be used for data type F (float).
Arctangent	ATAN(<input type="text" value="a"/>);	Arctangent of <input type="text" value="a"/> (-1 to +1) in radian value ($-\pi/2$ to $+\pi/2$) is returned. Specify arbitrary formula for argument <input type="text" value="a"/> . <ul style="list-style-type: none"> This can only be used for data type F (float).
Conversion from Angle to Radian	RAD(<input type="text" value="a"/>);	Value of <input type="text" value="a"/> is converted from degree ($^{\circ}$) to radian, and the value is returned. <ul style="list-style-type: none"> This can only be used for data type F (float).
Conversion from Radian to Angle	DEG(<input type="text" value="a"/>);	Value of <input type="text" value="a"/> is converted from radian to degree ($^{\circ}$), and the value is returned. <ul style="list-style-type: none"> This can only be used for data type F (float).

Data type conversion

Function	Format	Description
Conversion from BCD to Binary	BCD2BIN(<input type="text" value="a"/>)	BCD value of <input type="text" value="a"/> is returned in binary value. <ul style="list-style-type: none"> This can be used with data types W (word), I (integer), D (double word), and L (long).
Conversion from Binary to BCD	BIN2BCD(<input type="text" value="a"/>)	Binary value of <input type="text" value="a"/> is returned in BCD value. <ul style="list-style-type: none"> This can be used with data types W (word), I (integer), D (double word), and L (long).
Conversion from float to Binary	FLOAT2BIN(<input type="text" value="a"/>)	Float value of <input type="text" value="a"/> is returned in binary value. Values after the decimal point is truncated. <ul style="list-style-type: none"> This can be used with data types W (word), I (integer), D (double word), and L (long).
Conversion from Binary to float	BIN2FLOAT(<input type="text" value="a"/>)	Binary value of <input type="text" value="a"/> is returned in float value. <ul style="list-style-type: none"> This can be used with data types D (double word) and L (long).
Conversion from Decimal to String character	DEC2ASCII(<input type="text" value="a"/> , <input type="text" value="b"/>)	Decimal number value <input type="text" value="a"/> is converted to a character string, and store in order with <input type="text" value="b"/> as a starting device. <ul style="list-style-type: none"> This can be used with data types W (word), I (integer), D (double word), and L (long).
Conversion from String character to Decimal	ASCII2DEC(<input type="text" value="a"/>)	Character string <input type="text" value="a"/> is returned as decimal number value. <ul style="list-style-type: none"> This can be used with data types W (word), I (integer), D (double word), and L (long).

Data comparison and copy

Function	Format	Description
Data comparison	MEMCMP(<input type="text" value="a"/> , <input type="text" value="b"/> , <input type="text" value="c"/>)	<input type="text" value="a"/> : Starting device of comparison target 1 <input type="text" value="b"/> : Starting device of comparison target 2 <input type="text" value="c"/> : Range of comparison (in words) Values of device <input type="text" value="a"/> for <input type="text" value="c"/> words and values of device <input type="text" value="b"/> for words <input type="text" value="c"/> are compared. 1 is returned if all the values of devices match, and 0 is returned if any of the value does not match. <ul style="list-style-type: none"> Specified range is compared in word unit, and result is returned. Up to 64 words can be compared.

13: SCRIPTS

Function	Format	Description
Data copy	MEMCPY(<input type="text" value="a"/> , <input type="text" value="b"/> , <input type="text" value="c"/>)	<input type="text" value="a"/> : Starting device of copy source <input type="text" value="b"/> : Starting device of copy target <input type="text" value="c"/> : Range of copy (in words) Values from <input type="text" value="a"/> for <input type="text" value="c"/> words are copied to <input type="text" value="b"/> for <input type="text" value="c"/> words respectively. <ul style="list-style-type: none"> Specified range is compared in word unit, and result is returned. Up to 64 words can be copied.
Bit device (1 word length) to Bit device (1 word length)	BITS2BITS(<input type="text" value="a"/> , <input type="text" value="b"/>) ;	<input type="text" value="a"/> : Starting device of copy target (bit device) <input type="text" value="b"/> : Starting device of copy source (bit device) Copies one word worth of data from <input type="text" value="a"/> to <input type="text" value="b"/> . <ul style="list-style-type: none"> 16 bits are processed from the starting bit device as one word.
Bit device (1 word length) to Word device	BITS2WORD(<input type="text" value="a"/> , <input type="text" value="b"/>) ;	<input type="text" value="a"/> : Starting device of copy target (word device) <input type="text" value="b"/> : Starting device of copy source (bit device) Copies one word worth of data from <input type="text" value="a"/> to <input type="text" value="b"/> . <ul style="list-style-type: none"> 16 bits are processed from the starting bit device as one word.
Word device to Bit device (1 word length)	WORD2BITS(<input type="text" value="a"/> , <input type="text" value="b"/>) ;	<input type="text" value="a"/> : Starting device of copy target (bit device) <input type="text" value="b"/> : Starting device of copy source (word device) Copies one word worth of data from <input type="text" value="a"/> to <input type="text" value="b"/> . <ul style="list-style-type: none"> 16 bits are processed from the starting bit device as one word.

Offset

Function	Format	Description
Indirect specification	OFFSET(<input type="text" value="a"/> , <input type="text" value="b"/>)	<input type="text" value="a"/> : Reference device <input type="text" value="b"/> : Device to store the offset value (0 to 32767) Specifies the device at <input type="text" value="b"/> words from <input type="text" value="a"/> . Indirect read Specify OFFSET function to the right of the assignment statement. Format example: $c = \text{OFFSET}(\text{a}, \text{b}) = \text{c}$ Operation: Stores the value of device at <input type="text" value="b"/> words from <input type="text" value="a"/> into <input type="text" value="c"/> . Indirect write Specify OFFSET function to the left of the assignment statement. Format example: $\text{OFFSET}(\text{a}, \text{b}) = \text{c}$ Operation: Stores the value of <input type="text" value="c"/> into the device at <input type="text" value="b"/> words from <input type="text" value="a"/> . <ul style="list-style-type: none"> Store the value appropriate for the data type as the offset value. For example, when the data type is I (integer), store the offset value of I (integer) into the device.

Other

This section describes definitions for constant, device, temporary device, and comment.

■ Constant

Constant can be defined as decimal or hexadecimal number.

Sample definition of decimal numbers

1234	Define the numeric value directly.
-1234	Define the negative number with a "-" (minus) symbol at the beginning.
12.34	Decimal number can be defined for real numbers (float). Define a "." (period) between the whole numbers and decimal numbers.

There are 2 ways to define hexadecimal numbers.

Sample definition of hexadecimal numbers

0x12AB	Define "0" (zero) and "x" (lower case x) at the beginning of the value.
12ABh	Append "h" at the tail of the value.

■ Device Address

Device Address is defined with the device symbol and address within "[" and "]".

Definition of the device

[Device symbol and address]	(Space between the device symbol and address is not required.)
-----------------------------	--

Sample definition

[D0100]

■ Temporary Device

Temporary device is a device that can be used only inside the script. It can store a value and can be used as a variable.

It is defined with a device symbol "@" followed by address (1 – 32).

Definition of the temporary device

@address	(Space between the device symbol "@" and address is not required.)
----------	--

Sample definition

@2	Temporary device number 2
----	---------------------------

Note: All the values for temporary devices are set to "0" when the execution of the script is started.

■ Comment

A note defined in the script is called a comment. The line with "//" defined at the beginning of a line will become a comment.

"//" is defined with a single-byte. Double-byte characters can be written after "//".

Definition of comment

// Arbitrary note

Sample definition

// Store the initial value to calculation data [D0100] for process A [D0100] = 1234; : :	← This line is not executed.
---	------------------------------

Notes:

- Describing comments to explain the contents of the script is useful especially when another person works on the scripts or when some time has passed after editing the scripts.
- Comments are ignored (not executed) when the script is executed, so they can be defined freely without interfering the execution time.

Script Programming Examples

This section describes script programming examples for control statements, arithmetic operators, and functions, as well as their operations.

1. Control Statements

Example 1.1 Conditional branch

Script

```
if ([D0100])
{
    [D0102] = 100;
}
```

Operation Description

If the value of D0100 is not 0, then 100 is stored in D0102.

Example 1.2 Conditional branch

Script

```
if ([D0100])
{
    [D0102] = [D0103] + [D0104] + [D0105];
}
```

Operation Description

If the value of D0100 is not 0, the value of D0103, D0104, and D0105 are added and the result is stored in D0102.

Example 1.3 Conditional branch

Script

```
if (0 != [D0100])
{
    if (0 != [D0102])
    {
        [D0103] = 0x1234;
    }
}
```

Operation Description

If the value of D0100 is not 0 and the value of D0102 is not 0 either, 0x1234 is stored in D0103.

If the value of D0100 is not 0 and the value of D0102 is 0, then nothing is executed.

If the value of D0100 is 0, then nothing is executed regardless of the value of D0102.

Example 1.4 Conditional branch

Script

```
if ((0 != [D0100]) || (0 != [D0102]))
{
    [D0103] = 100;
}
else
{
    [D0104] = [D0105] + 100;
}
```

Operation Description

If either the value of D0100 or the value of D0102 is not 0, then 100 is stored in D0103.

If the values of both D0100 and D0102 are 0, 100 is added to D0105 and the result is stored in D0104.

Example 1.5 Conditional branch**Script**

```

if ([D0100] == 0)
{
    [D0102] = 0x1234;
}
else if ([D0100] == 1)
{
    [D0102] = 0x5678;
}
else
{
    [D0102] = 0x9999;
}

```

Operation Description

If the value of D0100 is 0, then 0x1234 is stored in D0102.

If the value of D0100 is 1, then 0x5678 is stored in D0102.

If the value of D0100 is not 0 nor 1, then 0x9999 is stored in D0102.

Example 1.6 Conditional branch**Script**

```

if ([D0100])
{
    if ([D0102])
    {
        if ([D0103])
        {
            [D0104] = 100;
        }
        else
        {
            [D0104] = 200;
        }
    }
}
}

```

Operation Description

If the value of D0100, D0102, and D0103 are all not 0, then 100 is stored in D0104.

If the values of D0100 and the value of D0102 are not 0 and the value of D0103 is 0, then 200 is stored in D0104.

If either the value of D0100 or D0102 is 0, then nothing is executed regardless of the value of D0103.

Example 1.7 Iteration**Script**

```

[D0100] = 10;
[D0102] = 10;

while (0 < [D0100])
{
    [D0102] = [D0102] + 1;
    [D0100] = [D0100] - 1;
}

```

Operation Description

If the value of D0100 is larger than 0, then 1 is repeatedly added to the value of D0102 and 1 is repeatedly subtracted from the value of D0100.

In the script example above, when the while statement repeats ten times, the value of D0100 becomes 0 and the while statement ends.

After this script is executed, the value of D0100 is 0 and the value of D0102 is 20.

Example 1.8 Iteration**Script**

```
[D0100] = 0;
[D0102] = 3;
[D0103] = 5;

while ([D0100] == 0)
{
    [D0102] = [D0102] + 1;

    if ([D0103] == [D0102])
    {
        SET([M0000]);
        break;
    }
}
```

Operation Description

While the value of D0100 is 0, the while statement is repeated.

Inside the while statement, if the values of D0102 and D0103 are equal, the while statement will terminate, and after [M0000] changes to 1, execution breaks out of the while statement.

In the example script above, the values of D0102 and D0103 are equal when the while statement repeats twice, and after M0000 changes to 1, execution breaks out of the while statement loop. After execution, the value of D0100 is 0, the value of D0102 is 5, the value of D0103 is 5, and M0000 is 1.

Example 1.9 Indirect write and indirect read using iteration (while statement)**Script**

```
//Transfer D0010 through D0019 to D0100 through D0109

// Initialize the offset value
[D0000] = 0;

// Loop ten times
while ([D0000] < 10)
{
    // Transfer 1 word by indirect assignment
    OFFSET([D0100] , [D0000]) = OFFSET([D0010] , [D0000]);
    // Increment indirect value
    [D0000] = [D0000] + 1
}
```

Operation Description

This script stores the values of D0010 through D0019 in D0100 through D0109.

It operates as follows.

First, the offset value D0000 is initialized and set to 0.

First iteration (loop) : The value of D0000 is 0, so the condition "[D0000] < 10" is true and the statements inside while are executed.

- The value of D0010, 0 words from D0010, is stored in D0100, 0 words from D0100.
- 1 is added to the value of offset value D0000, so that it becomes 1.

Second iteration (loop) : The value of D0000 is 1, so the condition "[D0000] < 10" is true and the statements inside while are executed.

- The value of D0011, 1 word from D0010, is stored in D0101, 1 word from D0100.
- 1 is added to the value of offset value D0000, so that it becomes 2.

:

(Repeats in the same manner for the third to ninth iterations)

:

Tenth iteration (loop) : The value of D0000 is 9, so the condition "[D0000] < 10" is true and the statements inside while are executed.

- The value of D0019, 9 words from D0010, is stored in D0109, 9 words from D0100.
- 1 is added to the value of offset value D0000, so that it becomes 10.

The value of D0000 is 10, so the condition "[D0000] < 10" is false and execution breaks out of the while loop.

After execution, the values of D0100 through D0109 are the same with the values of D0010 through D0019.

Example 1.10 Decimal to octal conversion using a while statement**Script**

```

// Convert a decimal value to octal
// - For example, convert 10 (dec) to 12 (oct), 16 (dec) to 20 (oct)
// - Convert a value to octal up to 4 digits max

@1 = 0;           // while counter
@2 = [D0100];    // gets original data
@3 = 1;         // decimal base
@4 = 0;         // calculation results

// repeat four times
while (@1 < 4)
{
    // Extract 1st octal digit from original data. Store working result in @10.
    @10 = @2 % 8;
    //Convert the extracted results to decimal and add to the results
    @4 = @4 + (@10 * @3);

    //Increase the decimal base by one digit
    @3 = @3 * 10;
    // Decrease the original data by one digit
    @2 = @2 / 8;
    // If @2 is 0, exit the while statement
    if (0 == @2)
    {
        break;
    }

    // Increment while counter by 1
    @1 = @1 + 1;
}

// Store the calculation result in D0200
[D0200] = @4;

```

Operation Description

This example converts a decimal value to octal using a while statement.

By repeating the process to divide the original decimal data by 8 and converting each digit to octal in a while statement, the conversion is implemented up to four digits.

The original decimal value is stored in D0100. After the script is executed, the converted octal value is stored in D0200.

Example 1.11 Conditional branch with switch**Script**

```

switch ([D0100])
{
    case 10:
        [D0200] = 0x1234;
        break;
    case 999:
        [D0200] = 0x5678;
        SET([D0000.01]);
        break;
}

```

Operation Description

If the value of D0100 is 10, then 0x1234 is stored in D0200.

If the value of D0100 is 999, then 0x5678 is stored in D0200 and D0000.01 is set to 1.

If the value of D0100 is not 10 nor 999, then nothing is executed.

Example 1.12 Conditional branch with switch using the default statement**Script**

```
switch ([D0100])
{
    case 0:
        [D0102] = 0x1234;
        break;
    case 1:
        [D0102] = 0x5678;
        break;
    default:
        [D0102] = 0x9999;
        break;
}
```

Operation Description

If the value of D0100 is 0, then 0x1234 is stored in D0102.

If the value of D0100 is 1, then 0x5678 is stored in D0102.

If the value of D0100 is not 0 nor 1, then 0x9999 is stored in D0102.

Example 1.13 Terminate the script with the return statement**Script**

```
if (0x1234 == [D0100])
{
    [D0102] = 0x5678;
    return;
}
[D0103] = 0;
```

Operation Description

If the value of D0100 is not 0x1234, then 0 is stored in D0103.

If the value of D0100 is 0x1234, then 0x5678 is stored in D0102 and the script is terminated.

The return statement does not break out of a loop like the break statement, it terminates the script execution.

Example 1.14 Break out of a loop with the break statement**Script**

```
[D0100] = 0;
[D0102] = 3;
[D0103] = 5;

while ([D0100] == 0)
{
    [D0102] = [D0102] + 1;

    if ([D0102] == [D0103])
    {
        SET([D0000.01]);
        break;
    }
}
```

Operation Description

While the value of D0100 is 0, the while statement is repeated until D0102 and D0103 match.

Inside the while statement, if the values of D0102 and D0103 are equal, the while statement will end and execution breaks out of the while statement.

In the example above, the values of D0102 and D0103 match when the while statement is repeated twice, and after D0000.01 changes to 1, the while statement ends. After execution, the value of D0100 is 0, the value of D0102 is 5, the value of D0103 is 5, and the value of D0000.01 is 1.

2. Relational Operators

Example 2.1 Equal to

Script

```
if ([D0100] == [D0102])
{
    [D0103] = 0x100;
}
```

Operation Description

If the value of D0100 is equal to the value of D0102, then 0x100 is stored in D0103.

Example 2.2 Not equal to

Script

```
if ([D0100] != [D0102])
{
    [D0103] = 0x100;
}
```

Operation Description

If the value of D0100 is not equal to the value of D0102, then 0x100 is stored in D0103.

Example 2.3 Less than

Script

```
if ([D0100] < [D0102])
{
    [D0103] = 0x100;
}
```

Operation Description

If the value of D0100 is less than the value of D0102, then 0x100 is stored in D0103.

Example 2.4 Less than or equal to

Script

```
if ([D0100] <= [D0102])
{
    [D0103] = 0x100;
}
```

Operation Description

If the value of D0100 is less than or equal to the value of D0102, then 0x100 is stored in D0103.

Example 2.5 Greater than

Script

```
if ([D0100] > [D0102])
{
    [D0103] = 0x100;
}
```

Operation Description

If the value of D0100 is greater than the value of D0102, then 0x100 is stored in D0103.

Example 2.6 Greater than or equal to

Script

```
if ([D0100] >= [D0102])
{
    [D0103] = 0x100;
}
```

Operation Description

If the value of D0100 is greater than or equal to the value of D0102, then 0x100 is stored in D0103.

3. Logical Operators

Example 3.1 Logical AND**Script**

```
if (([D0100] == [D0200]) && ([D0300] == [D0400] + [D0500]))
{
    [D0600] = 100;
}
```

Operation Description

If the value of D0100 is equal to the value of D0200, and if the value of D0300 is equal to the value of D0400 and D0500 added together, then 100 is stored in D0600.

If either $([D0100] == [D0200])$ or $([D0300] == [D0400] + [D0500])$ is false, the processing in the brackets "{ }" is not executed.

Example 3.2 Logical OR**Script**

```
if ((0 != [D0100]) || (0 != [D0200]))
{
    [D0300] = 100;
}
```

Operation Description

If the value of D0100 is not 0 or the value of D0102 is not 0, then 100 is stored in D0300.

If either one of them is true, the processing in the brackets "{ }" is executed.

Example 3.3 Logical inversion**Script**

```
if (!( [D0100] == 0x1234 ))
{
    [D0300] = 100;
}
```

Operation Description

If the value of D0100 is not equal to 0x1234, then 100 is stored in D0300.

Example 3.4 Logical inversion**Script**

```
if (!(0 != [D0100]))
{
    [D0300] = 100 ;
}
```

Operation Description

If the value of D0100 is 0, then 100 is stored in D0300.

This is the same as the code "if (0==[D0100])".

4. Arithmetic Operators

Example 4.1 Addition

Script

```
[D0300] = [D0100] + [D0200];
```

Operation Description

The values of D0100 and D0200 are added together and the result is stored in D0300.

Example 4.2 Subtraction

Script

```
[D0300] = [D0100] - [D0200];
```

Operation Description

The value of D0200 is subtracted from the value of D0100 and the result is stored in D0300.

Example 4.3 Multiplication

Script

```
[D0300] = [D0100] * [D0200];
```

Operation Description

The values of D0100 and D0200 are multiplied together and the result is stored in D0300.

Example 4.4 Division

Script

```
[D0300] = [D0100] / [D0200];
```

Operation Description

The value of D0100 is divided by the value of D0200 and the result is stored in D0300.

Example 4.5 Modulo

Script

```
[D0300] = [D0100] % [D0200];
```

Operation Description

The value of D0100 is divided by the value of D0200 and the remainder is stored in D0300.

5. Bitwise Operators

Example 5.1 Logical AND

Script

```
if ([D0000.01] & [D0001.01])
{
    SET([D0002.01]);
}
else
{
    RST([D0002.01]);
}
```

Operation Description

If the bitwise logical AND operation on the value of D0000.01 and the value of D0001.01 is 1, D0002.01 is changed to 1. If the bitwise logical AND operation on the value of D0000.01 and the value of D0001.01 is 0, D0002.01 is changed to 0. The operation is the same as the following ladder diagram.

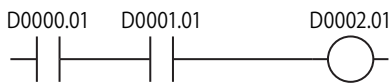

Example 5.2 Logical OR

Script

```
if ([D0000.01] | [D0001.01])
{
    SET([D0002.01]);
}
else
{
    RST([D0002.01]);
}
```

Operation Description

If the bitwise logical OR operation on the value of D0000.01 and the value of D0001.01 is 1, D0002.01 is changed to 1. If the bitwise logical OR operation on the value of D0000.01 and the value of D0001.01 is 0, D0002.01 is changed to 0. The operation is the same as the following ladder diagram.

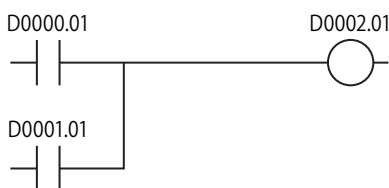

Example 5.3 Logical XOR (exclusive OR)

Script

```
[D0200] = [D0100] ^ 0xFF;
```

Operation Description

The logical XOR operation on the value of D0100 and each bit in 0xFF is stored in D0200. For example, if the value of D0100 is 15 (0x0F), then 240 (0xF0) is stored in D0200.

Example 5.4 Inversion

Script

```
[D0200] = ~[D0100];
```

Operation Description

The bits in the value of D0100 are inverted and stored in D0200. For example, if the value of D0100 is 0, then 65,535 is stored in D0200.

Example 5.5 Inversion**Script**

```

if (([D0000.01] & ~[D0001.01]) | [D0002.01])
{
    SET([D0003.01]);
}
else
{
    RST([D0003.01]);
}

```

Operation Description

If the bitwise logical OR operation on the value of D0002.01 and the result of the bitwise logical AND operation on the value of D0000.01 and the inverted result of the value of D0001.01 is 1, then D0003.01 is changed to 1.

If the bitwise logical OR operation on the value of D0002.01 and the result of the bitwise logical AND operation on the value of D0000.01 and the inverted result of the value of D0001.01 is 0, D0003.01 is changed to 0.

The operation is the same as the following ladder diagram.

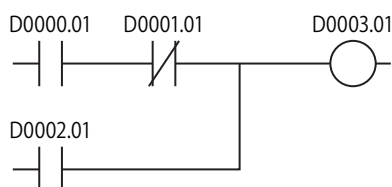
**Example 5.6** Left shift**Script**

```
[D0300] = [D0100] << [D0200];
```

Operation Description

The value of D0100 is shifted to the left by the value of D0200 and the result is stored in D0300.

For example, if the value of D0100 is 1 and the value of D0200 is 3, 1 is shifted 3 bits to the left, and the result of 8 is stored in D0300.

Example 5.7 Right shift**Script**

```
[D0300] = [D0100] >> [D0200];
```

Operation Description

The value of D0100 is shifted to the right by the value of D0200 and the result is stored in D0300.

For example, if the value of D0100 is 8 and the value of D0200 is 3, 8 is shifted 3 bits to the right, and the result of 1 is stored in D0300.

6. Bit Functions

Example 6.1 Set a bit

Script

```
SET([D0000.01]);
```

Operation Description

Turns D0000.01 to 1. The result is the same as $[D0000.01] = 1$.

Example 6.2 Reset a bit

Script

```
RST([D0000.01]);
```

Operation Description

Turns D0000.01 to 0. The result is the same as $[D0000.01] = 0$.

Example 6.3 Invert a bit

Script

```
REV([D0000.01]);
```

Operation Description

Inverts 1 and 0 in D0000.01. The result is the same as $[D0000.01] = \sim[D0000.01]$.

7. Word Functions

Arithmetic operations

Example 7.1 Maximum value

Script

```
[D0200] = MAX([D0100], [D0110], [D0120], [D0130], [D0140]);
```

Operation Description

Out of the values stored in D0100, D0110, D0120, D0130, and D0140, the maximum value is stored in D0200.

Up to 15 arguments can be used.

Example 7.2 Minimum value

Script

```
[D0200] = MIN([D0100], [D0110], [D0120], [D0130], [D0140]);
```

Operation Description

Out of the values stored in D0100, D0110, D0120, D0130, and D0140, the minimum value is stored in D0200.

Up to 15 arguments can be used.

Example 7.3 Exponential function

Script

```
[D0010] = EXP([D0020]);
```

Operation Description

Calculates the exponential function of the value of D0020 and the result is stored in D0010.

Only the data type F (float) can be used.

Example 7.4 Natural logarithm**Script**

```
[D0010] = LOGE([D0020]);
```

Operation Description

Calculates the natural logarithm of the value of D0020 and the result is stored in D0010.

Only the data type F (float) can be used.

Example 7.5 Common logarithm**Script**

```
[D0010] = LOG10([D0020]);
```

Operation Description

Calculates the logarithm of the value of D0020 with 10 as the base and the result is stored in D0010.

Only the data type F (float) can be used.

Example 7.6 Power**Script**

```
[D0010] = POW([D0020],[D0030]);
```

Operation Description

Calculates the power of the values.

For example, if the value of D0020 is 10 and the value of D0030 is 5, the function calculates 10 to the power of 5 and stores the result in D0010.

Only the data type F (float) can be used.

Example 7.7 Square root**Script**

```
[D0010] = ROOT([D0020]);
```

Operation Description

Calculates the square root of the value of [D0020] and the result is stored in [D0010].

Only the data type F (float) can be used.

Example 7.8 Sine**Script**

```
[D0010] = SIN([D0020]);
```

Operation Description

Calculates the sine of the radian value of D0020 and stores the result in D0010.

Only the data type F (float) can be used.

Example 7.9 Cosine**Script**

```
[D0010] = COS([D0020]);
```

Operation Description

Calculates the cosine of the radian value of D0020 and stores the result in D0010.

Only the data type F (float) can be used.

13: SCRIPTS

Example 7.10 Tangent

Script

```
[D0010] = TAN([D0020]);
```

Operation Description

Calculates the tangent of the radian value of D0020 and stores the result in D0010. Only the data type F (float) can be used.

Example 7.11 Arcsine

Script

```
[D0010] = ASIN([D0020]);
```

Operation Description

Calculates the arcsine of the value of D0020 and stores the result as radians in D0010. Only the data type F (float) can be used.

Example 7.12 Arccosine

Script

```
[D0010] = ACOS([D0020]);
```

Operation Description

Calculates the arccosine of the value of D0020 and stores the result as radians in D0010. Only the data type F (float) can be used.

Example 7.13 Arctangent

Script

```
[D0010] = ATAN([D0020]);
```

Operation Description

Calculates the arctangent of the value of D0020 and stores the result as radians in D0010. Only the data type F (float) can be used.

Example 7.14 Convert angle to radians

Script

```
[D0010] = RAD([D0020]);
```

Operation Description

Converts the value of D0020 from degrees (°) to radians and stores the result in D0010. Only the data type F (float) can be used.

Example 7.15 Convert radians to angle

Script

```
[D0010] = DEG([D0020]);
```

Operation Description

Converts the value of D0020 from radians to degrees (°) and stores the result in D0010. Only the data type F (float) can be used.

Data type conversions

Example 7.16 Convert BCD to binary

Script

```
[D0200] = BCD2BIN([D0100]);
```

Operation Description

Converts the BCD value in D0100 to a binary value and stores it in D0200.
For example, if the BCD value 10 (16 as a binary value) is stored in D0100, 10 (binary value) is stored in D0200.

Example 7.17 Convert binary to BCD

Script

```
[D0200] = BIN2BCD([D0100]);
```

Operation Description

Converts the binary value in D0100 to a BCD value and stores it in D0200.
For example, if the binary value 16 (10 as a BCD value) is stored in D0100, 16 (BCD value) is stored in D0200.

Example 7.18 Convert float to binary

Script

```
[D0200] = FLOAT2BIN([D0100]);
```

Operation Description

Converts the float value in D0100 to a binary value and stores it in D0200.
For example, if the data type F (float) 1234.0 (0x449A4000 as a binary value) is stored in D0100, 1234 (binary value) is stored in D0200. If the data type F (float) 1234.56 (0x449A51EC as a binary value) is stored in D0100, the value after the decimal point is truncated and 1234 (binary value) is stored in D0200.

Example 7.19 Convert binary to float

Script

```
[D0200] = BIN2FLOAT([D0100]);
```

Operation Description

Converts the binary value in D0100 to a float value and stores it in D0200.
For example, if the binary value 1234 is stored in D0100, the float value 1234.0 (0x449A4000 as a binary value) is stored in D0200.

Example 7.20 Convert decimal to string

Script

```
DEC2ASCII([D0100], [D0200]);
```

Operation Description

Converts the decimal numeric value in D0200 to a string and stores it in order with D0100 as the starting address.

Notes:

- This function can be used with data types W (word), I (integer), D (double word), and L (long).
- The NULL terminating character (0x00) is added to the end of the string.

Converting 1234 (when the data type is W (word))

Device	Stored value	Stored value	
		Upper byte	Lower byte
D0200	1234		
D0100		'1' = 0x31	'2' = 0x32
D0101		'3' = 0x33	'4' = 0x34
D0102		0x00	0x00

Terminating character

Converting -12345 (when the data type is I (integer))

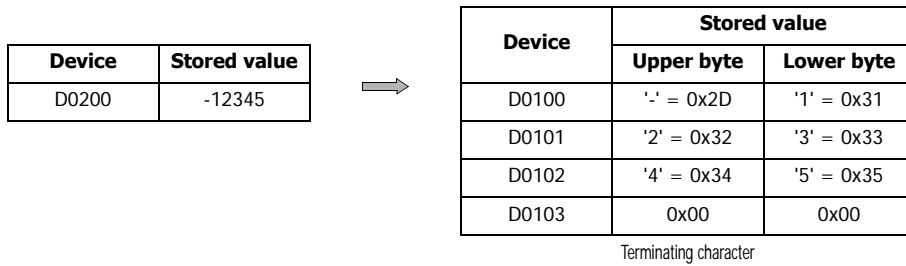

Converting 1234567890 (when the data type is D (double word))

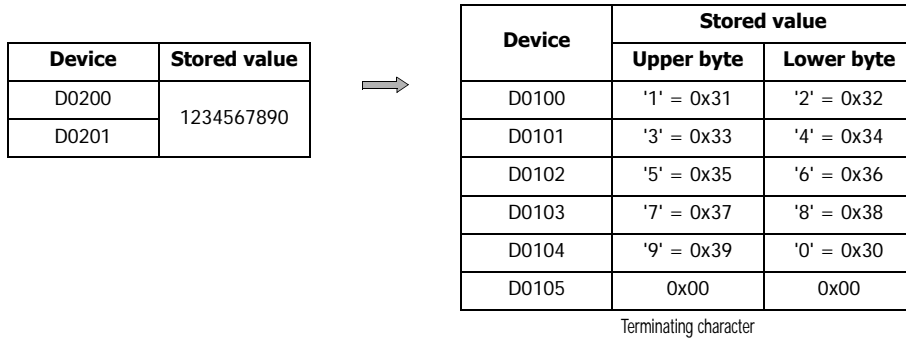

Converting -1234567890 (when the data type is L (long))

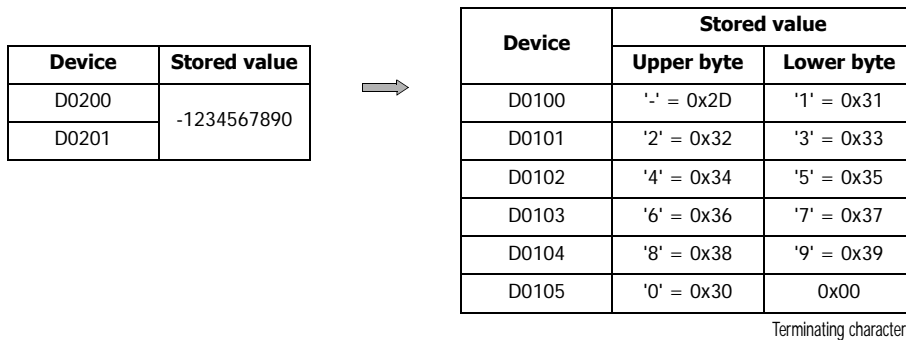

Example 7.21 Convert string to decimal

Script

```
[D0100] = ASCII2DEC([D0200]);
```

Operation Description

Converts the stored string starting at D0200 to a decimal and stores the result in D0100. The number of digits that can be converted is the maximum number of digits for each data type with added sign. If the string to convert contains a NULL or characters that cannot be converted to numeric values, the string is converted up to that character.

Notes:

- This function can be used with data types W (word), I (integer), D (double word), and L (long).
- The NULL terminating character (0x00) is added to the end of the string.

Setting the string "1234" (when the data type is W (word))

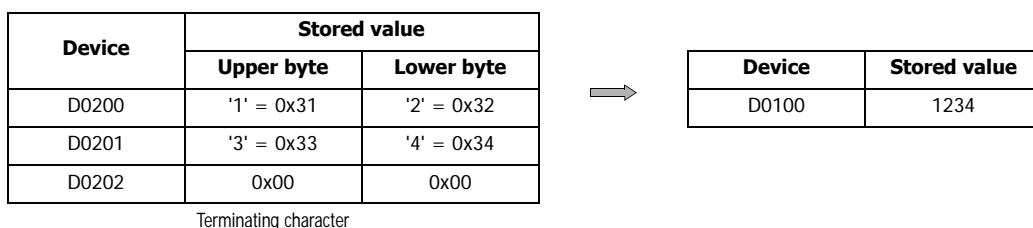

Setting the string "1234567" (when the data type is D (double word))

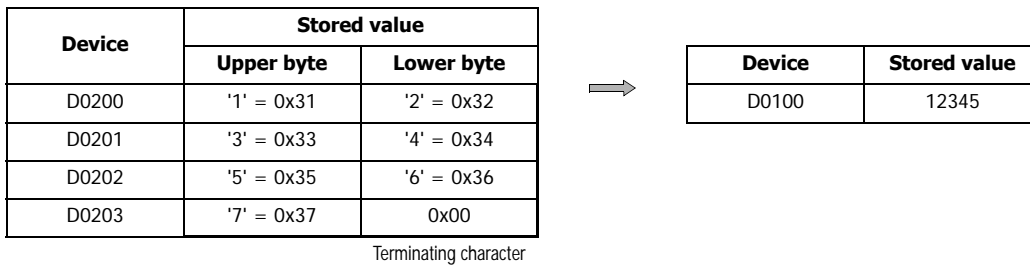

Setting the string "-12345" (when the data type is I (integer))

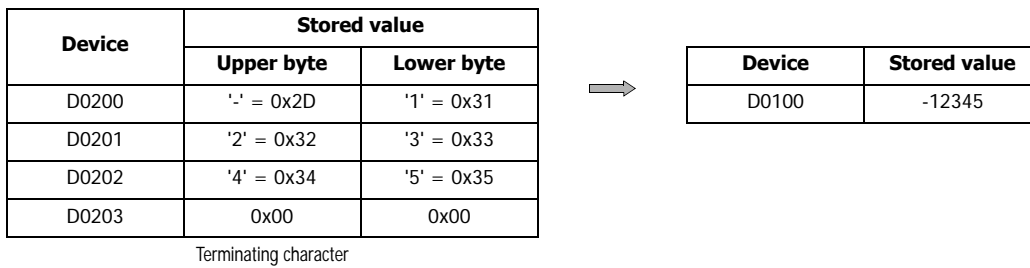

String "1234567890" (when the data type is L (long))

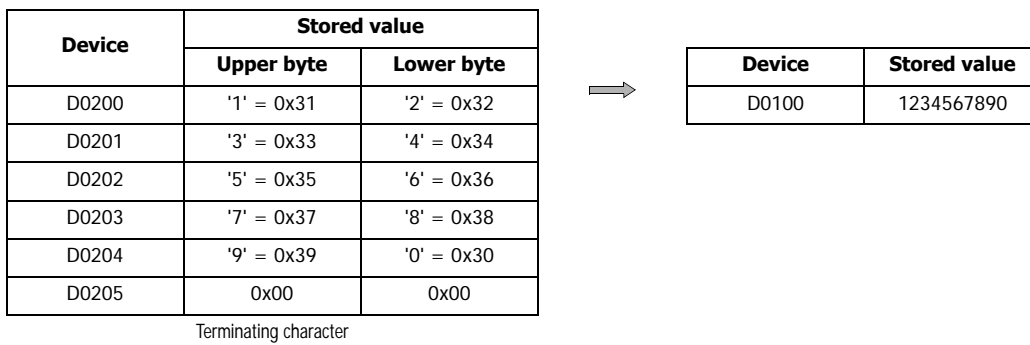

Data comparison and copying

Example 7.22 Word-unit data comparison

Script

```
[D0000] = MEMCMP([D0100], [D0200], 10);
```

Operation Description

Compares the values of 10 words from D0100 (up to D0109) with the values of 10 words from D0200 (up to D0209). If the value for each is entirely equal, 1 is stored in D0000. If even a single one is not equal, 0 is stored.

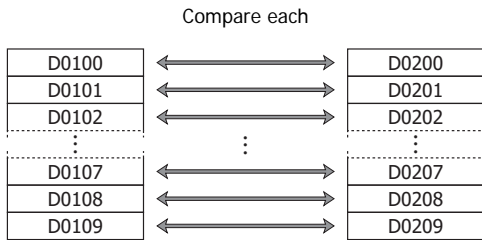

Note: Even if the data type is set to D (double word), L (long), or F (float), the comparison is performed from the starting device in word units.

Example 7.23 Bit-unit data comparison

Script

```
[D0000] = MEMCMP([D0100.02], [D0200.00], 10);
```

Operation Description

Compares the third bit of D0100 through the third bit of D0109 with the state of the bits from the first bit of D0200 through the first bit of D0209.

If the value for each is entirely equal, 1 is stored in D0000. If even a single one is not equal, 0 is stored.

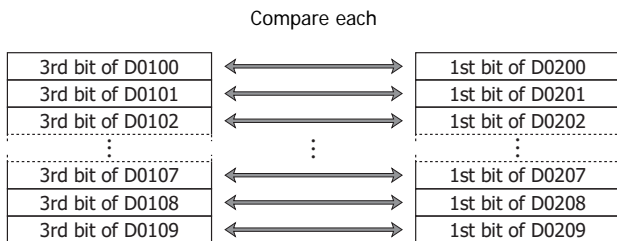

Note: Even if the data type is set to D (double word), L (long), or F (float), the comparison is performed from the starting device in bit units.

Example 7.24 Word-unit data copy

Script

```
MEMCPY([D0100], [D0200], 10);
```

Operation Description

Copies the value of 10 word devices from D0200 (up to D0209) to 10 word devices from D0100 (up to D0109).

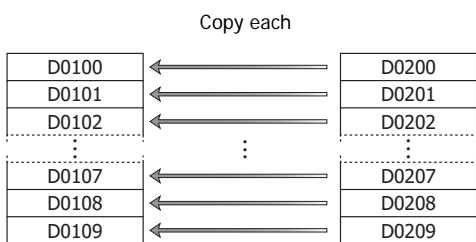

Note: Even if the data type is set to D (double word), L (long), or F (float), the data is copied from the starting device in word units.

Example 7.25 Bit-unit data copy

Script

```
MEMCPY([D0200.00], [D0100.02], 10);
```

Operation Description

Copies the third bit of 10 words from D0100 (up to D0109) to the bit state for 10 bits of devices from D0200 (up to D0209).

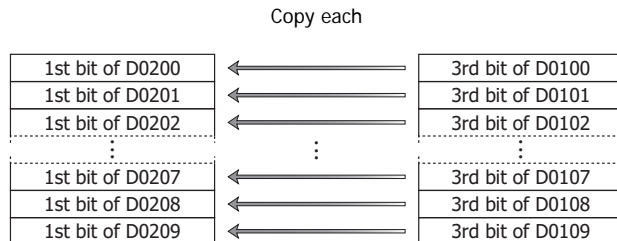

Note: Even if the data type is set to D (double word), L (long), or F (float), the bits are copied from the starting device in bit units.

Example 7.26 Copy 1 word from bit devices to bit devices

Script

```
BITS2BITS(I004, M0000);
```

Operation Description

A value of 1 word length from I004 (I004 to I023) is copied to the bit states of a 1 word region from M0000 (M0000 to M0017).

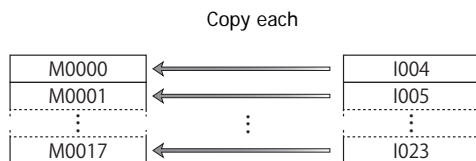

Example 7.27 Copy 1 word from bit devices to a word device

Script

```
BITS2WORD(I004, D0000);
```

Operation Description

A value of 1 word length from I004 (to I023) is copied to the value of device D0000. This is the same as BITS2BITS (I004, D0000.0);.

Example 7.28 Copy 1 word from a word device to bit devices

Script

```
WORD2BITS(D0100, M0000);
```

Operation Description

The value of device D0100 is copied to the bit states of a value of 1 word length from M0000 (M0000 to M0017). This is the same as BITS2BITS (D1000.0, M0000);.

Indirect assignment

Example 7.29 Indirect read

Script

```
[D0200] = OFFSET([D0010],[D0020]);
```

Operation Description

When the value of D0020 is 8, the value of D0018, the device 8 words from D0010, is read and stored in D0200.

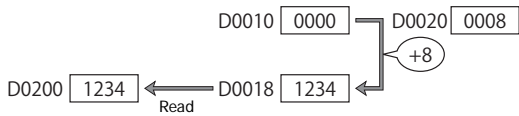

Example 7.30 Indirect write

Script

```
OFFSET([D0010],[D0020]) = 1234;
```

Operation Description

When the value of D0020 is 3, the constant 1234 is stored in D0013, the device 3 words from D0010.

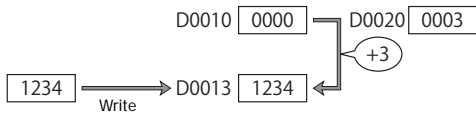

Important Notes

This section describes important notes when programming scripts.

Important Notes Regarding While Definition

■ Define so the execution does not go into an infinite loop.

The execution expression is repeatedly executed while the conditional expression is satisfied.

However, it will go into an infinite loop when the conditional expression is satisfied continually.

```
[D0100] = 10;

while (0 != [D0100])
{
    [D0200] = [D0200] + 1;
}
```

In the conditional expression of the while definition, it states to exit the loop when the value of D0100 turns 0. However, the value stored in D0100 is not changed after string 10 in the first line of the script, so the execution goes into an infinite loop.

When using the while definition, define it so the execution will not go into an infinite loop.

If the execution becomes an infinite loop, the scan time will exceed the watchdog timer setting and a watchdog timer error will occur.

The value of D0100 becomes 0 when the while definition is repeated 10 times in the following example, and the execution will get out of the while definition.

```
[D0100] = 10;

while (0 != [D0100])
{
    [D0200] = [D0200] + 1;
    [D0100] = [D0100] - 1;
}
```

About the Priority of the Operator

Operators are processed in the order from the left in each line. When multiple operations are combined, the operators are processed in the following priorities.

Priority	Operator
<div style="text-align: center;"> <p>High</p>  <p>Low</p> </div>	()
	! ~ - (Negative number)
	* / %
	+ - (Subtraction)
	<< >>
	&
	^
	< <= > >=
	== !=
	&&
	=

14: TROUBLESHOOTING

Introduction

This chapter describes the procedures to determine the cause of problem and actions to be taken when any problem occurs while operating the SmartAXIS.

The SmartAXIS has self-diagnostic functions to prevent the spread of problems if any should occur. In case of any problem, follow the troubleshooting procedures to determine the cause and to correct the error.

Errors are checked in various stages. While editing a user program on WindLDR, incorrect devices and other data are rejected. User program syntax errors are found during compilation on WindLDR. When an incorrect program is downloaded to the SmartAXIS, user program syntax errors are still checked. Errors are also checked at starting and during operation of the SmartAXIS. When an error occurs, the error is reported by turning on the ERR LED on the SmartAXIS Lite and an error message can be viewed on WindLDR. For the procedure to confirm the error status and clear the error on the SmartAXIS Pro, see "Checking/Clearing Error Information" on page 6-20.

Reading Error Data

When any error occurs during the SmartAXIS operation, "Error" is indicated and error details can be read using WindLDR.

Monitoring WindLDR

1. From the WindLDR menu bar, select **Online > Monitor > Monitor**. The monitor mode is enabled.
2. From the WindLDR menu bar, select **Online > Status**. The PLC Status dialog box appears.
When any error exists, "Error" is displayed in the error status box.

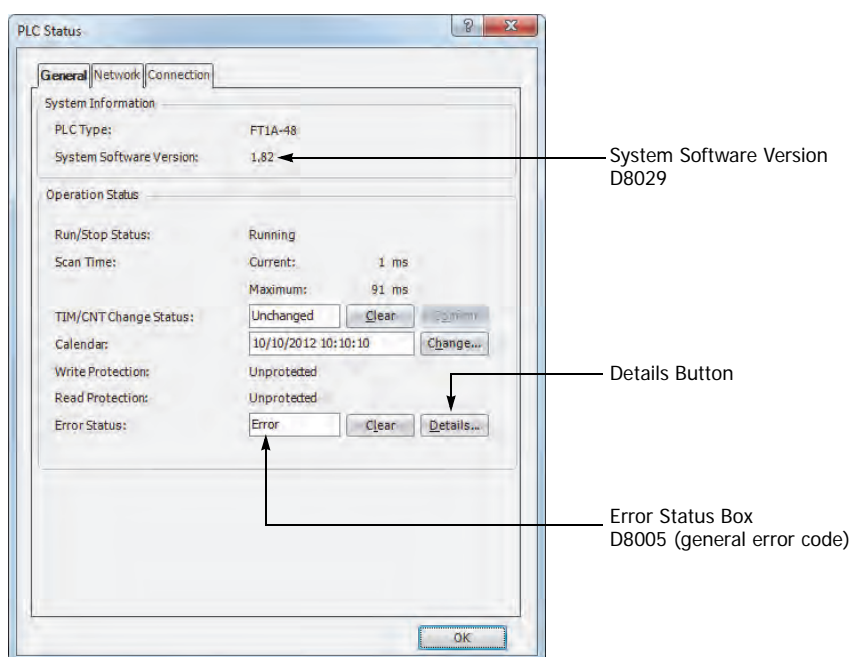

14: TROUBLESHOOTING

3. On the right of the Error Status in the PLC Status dialog box, click the **Details** button.
The PLC Error Status screen appears.

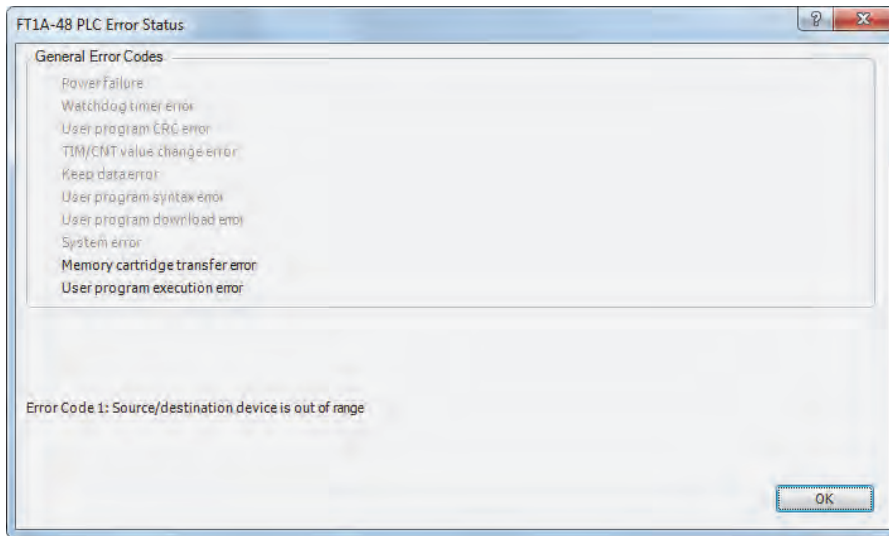

Clearing Error Codes from WindLDR

After removing the cause of the error, clear the error code using the following procedure:

1. From the WindLDR menu bar, select **Online > Monitor > Monitor**. The monitor mode is enabled.
2. From the WindLDR menu bar, select **Online > Status**. The PLC Status dialog box appears.
3. On the right of the **Error Status** in the PLC Status dialog box, click the **Clear** button.

This procedure clears the error code from special data register D8005 (general error code), and the error is cleared from the PLC Status dialog box.

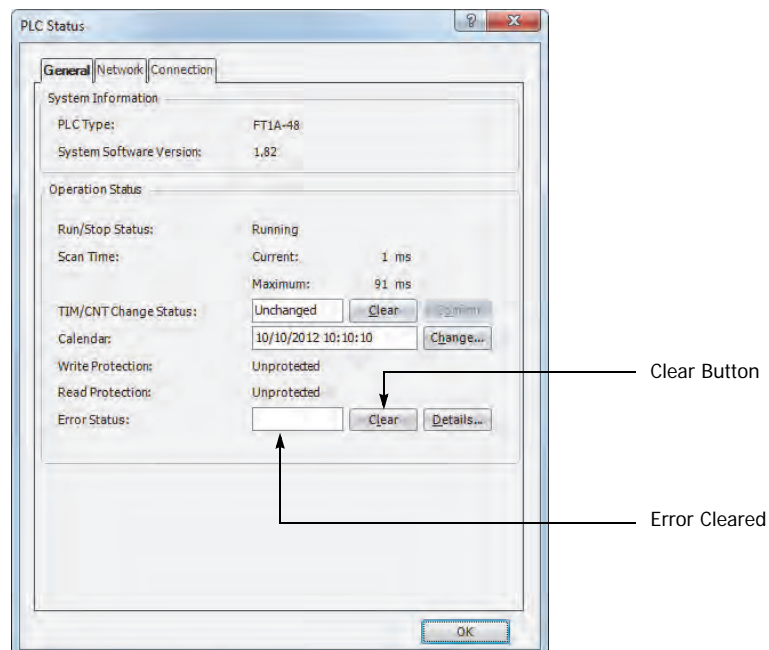

Special Data Registers for Error Information

Two data registers are assigned to store information on errors.

D8005	General Error Code
D8006	User Program Execution Error Code

Example: This ladder program clears the error information using the error clear bit of special data register D8005.

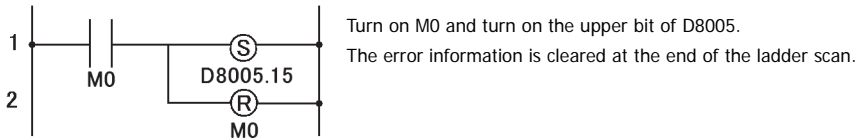

General Error Codes

The error code is stored in special data register D8005.

If '1' is stored in each bit of D8005, the corresponding error is occurring.

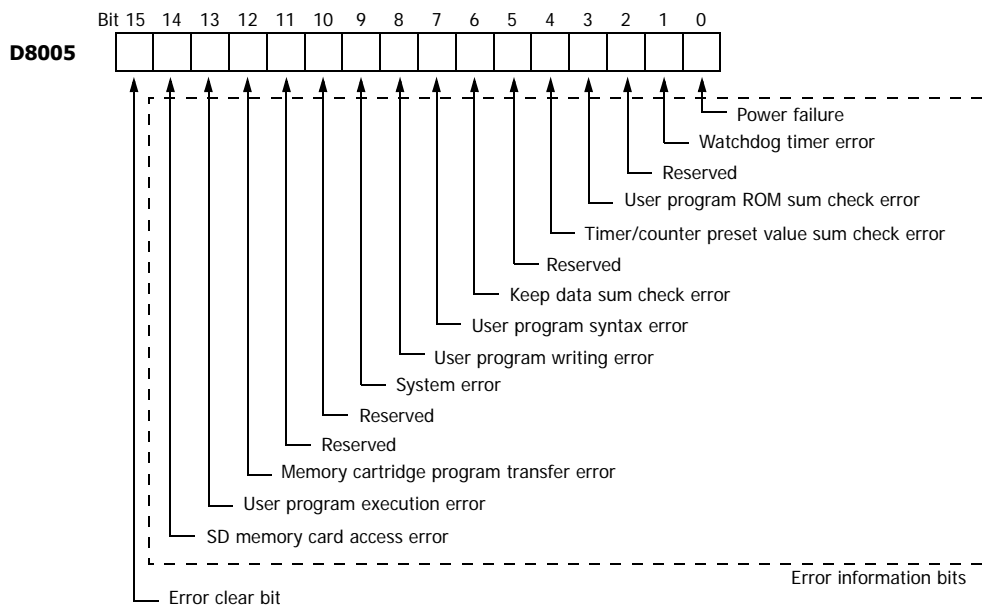

SmartAXIS Operating Status, Output, and ERR LED during Errors

Error Items	Operating Status	Output	ERR LED	Checked at
Power failure	Stop	OFF	OFF	Any time
Watchdog timer error	Stop	OFF	ON	Any time
User program ROM sum check error	Stop	OFF	ON	Starting operation
TIM/CNT preset value sum check error	Maintained	Maintained	ON	When checking a change in timer/counter settings
Keep data error	Maintained/Stop *1	Maintained/OFF *1	OFF	Turning power on
User program syntax error	Stop	OFF	ON	Downloading user program
User program writing error	Stop	OFF	ON	Downloading user program
System error	Stop	OFF	ON	Turning power on
Memory cartridge program transfer error	Stop	OFF	ON	Turning power on
User program execution error	Maintained	Maintained	ON	Executing user program
SD memory card access error	Maintained	Maintained	ON	When an SD memory card is inserted

*1: Operation starts to run and outputs are turned on or off according to the user program as default, but it is also possible to stop operation and turn off outputs using the Function Area Settings on WindLDR. See "Run/Stop Selection at Memory Backup Error" on page 5-5.

*2: The SmartAXIS Pro has no error status LED.

Error Causes and Actions

0001h: Power Failure

This error indicates when the power supply is lower than the specified voltage. This error is also recorded when the power is turned off. Clear the error code using WindLDR.

0002h: Watchdog Timer Error

The watchdog timer monitors the time required for one program cycle (scan time). When the time exceeds the allowed time, the watchdog timer indicates an error. Clear the error code using WindLDR. If this error occurs frequently, the SmartAXIS has to be replaced.

0008h: User Program ROM Sum Check Error

The user program stored in the SmartAXIS ROM is corrupted. Download a correct user program to the SmartAXIS, and clear the error code using WindLDR.

When a memory cartridge is installed on the SmartAXIS, the user program in the memory cartridge is checked.

0010h: Timer/Counter Preset Value Sum Check Error

The execution data of timer/counter preset values is corrupted. The timer/counter preset values are initialized to the values of the user program automatically. Note that changed preset values are cleared and that the original values are restored. Clear the error code using WindLDR.

0040h: Keep Data Sum Check Error

This error indicates that the data designated to be maintained during power failure is corrupted because of memory backup failure. Note that the "keep" data of internal relays and shift registers are cleared. Data of counters and data registers are also cleared. Clear the error code using WindLDR.

If this error occurs in a short period of power interruption after the battery has been charged as specified, the battery is defective and the SmartAXIS has to be replaced.

0080h: User Program Syntax Error

This error indicates that the user program has a syntax error. Correct the user program, and download the corrected user program to the SmartAXIS. The error code is cleared when a correct user program is transferred.

0100h: User Program Writing Error

This error indicates a failure of writing into the SmartAXIS ROM when downloading a user program. The error code is cleared when writing into the ROM is completed successfully. If this error occurs frequently, the SmartAXIS has to be replaced.

When a memory cartridge is installed on the SmartAXIS, writing into the memory cartridge is checked.

0200h: System Error

This error is issued when ROM is not found. When this error occurred, turn power off and on. Clear the error code using WindLDR. If this error occurs frequently, the SmartAXIS has to be replaced.

1000h: Memory Cartridge Program Transfer Error

This error indicates that the user program cannot be downloaded to/uploaded from SmartAXIS using the memory cartridge. The memory cartridge program transfer fails when one of the following conditions is met:

- When the user program in the SmartAXIS is password-protected and the password of the user program in the memory cartridge does not match. Configure the correct password to the user program in the memory cartridge. For details on entering the password, see "User Program Protection" on page 5-64.
- When uploading the user program from the SmartAXIS is prohibited. Upload cannot be executed.

2000h: User Program Execution Error

This error indicates that invalid data is found during execution of a user program. When this error occurs, special internal relay M8004 (user program execution error) is turned on.

Referring to the next page to fix and clear the error code.

User Program Execution Error

This error indicates that invalid data is found during execution of a user program. When this error occurs, the ERR LED and special internal relay M8004 (user program execution error) turned on. The detailed information of this error can be viewed from the error code stored in special data register D8006 (user program execution error code).

User Program Execution Error Code (D8006)	Error Details
1	Source/destination device exceeds range.
2	MUL result exceeds data type range.
3	DIV result exceeds data type range, or division by 0.
4	BCDLS has S1 or S1+1 exceeding 9999.
5	S1 is 10,000 or higher in the HTOB(W) instruction, or S1 is 100,000,000 or higher in the HTOB(D) instruction.
6	BTOH has any digit of S1 exceeding 9.
7	HTOA/ATOH/BTOA/ATOB has quantity of digits to convert out of range.
8	ATOH/ATOB has non-ASCII data for S1 through S1+4.
9	In the WEEK instruction, the ON time data exceeds range (hour data is 24 or higher, minute data is 60 or higher), or the OFF time data exceeds range (hour data is 25 or higher, minute data is 60 or higher).
10	In the YEAR instruction, the month and day data exceeds range (month data is 13 or higher, day data is 32 or higher).
12	CVXTY/CVYTX is executed without matching XYFS. XYFS and CVXTY/CVYTX have the same S1, but have different data types.
13	CVXTY/CVYTX has S2 exceeding the value specified in XYFS.
14	Label in LJMP, LCAL, or DJNZ is not found.
18	Attempt was made to execute an instruction that cannot be used in an interrupt program: SOTU, SOTD, TML, TIM, TMH, TMS, CNT, CDP, CUD, SFR, SFRN, WEEK, YEAR, MSG, TXD, RXD, DI, EI, XYFS, CVXTY, CVYTX, AVRG, PULS, PWM, RAMP, ZRN, ARAMP, DTML, DTIM, DTMH, DTMS, TTIM, FIFOF, NDSRL, HOUR, ETXD, ERXD, DLOG, and TRACE (see "Ladder Program Instructions List" on page 8-1).
19	Attempt was made to execute an instruction that is not available for the PLC.
20	PULS, PWM, RAMP, ZRN, or ARAMP has an invalid value in control registers.
21	DECO has S1 exceeding 255.
22	BCNT has S2 exceeding 256.
23	ICMP>= has S1 < S3.
25	BCDLS has S2 exceeding 7.
26	DI or EI is executed when interrupt input or timer interrupt is not programmed in the Function Area Settings.
27	Work area is broken when using DTML, DTIM, DTMH, DTMS, or TTIM.
28	S1 for trigonometric function instruction is invalid.
29	Result of F (float) data type instruction exceeds the data type range.
30	The number of bits configured in the SFTL/SFTR instruction or SFR FB exceeds the valid range.
31	In the FIFOF instruction, the FIEX instruction or the FOEX instruction was executed before the FIFO data file was registered.
32	TADD, TSUB, HOUR, or HTOS has invalid data for source device S1 or HOUR FB has invalid data for the Preset value.
34	NDSRC has invalid data for source device S3.
35	In the SUM instruction, the execution result exceeds the valid range for the selected data type, or S2 data is 0.
36	DLOG/TRACE is executed but the capacity of CSV file exceeds 5 MB.
41	SD memory card is write protected.
42	The result of execution using the SCRPT instruction/FB is a value that indicates anything other than normal completion.
43	The minimum value is greater than the maximum value in RCMP FB.
44	The shift registers specified by the start shift register and the number of bits in SFR FB does not exist.
45	In RPULS FB, the minimum value of ON time is greater than the maximum value of ON time, or the maximum value of ON time is greater than the cycle time.

Troubleshooting Diagrams

When one of the following problems is encountered, see the following trouble shooting diagrams:

Problem	Troubleshooting Diagram
The power is not on.	Diagram 1
Operation has not started.	Diagram 2
An error has occurred.	Diagram 3
Input does not operate normally.	Diagram 4
Output does not operate normally.	Diagram 5
Communication between WindLDR on a computer and the SmartAXIS is not possible.	Diagram 6
Cannot stop or reset operation.	Diagram 7
Watchdog timer error occurs and the CPU does not run.	Diagram 8
The interrupt/catch input cannot receive short pulses.	Diagram 9
Frequency measurement does not work.	Diagram 10
Data is not transmitted at all in the user communication mode. (24-, 40-, 48-I/O types only)	Diagram 11
Data is not transmitted correctly in the user communication mode. (24-, 40-, 48-I/O types only)	Diagram 12
Data is not received at all in the user communication mode. (24-, 40-, 48-I/O types only)	Diagram 13
Data is not received correctly in the user communication mode. (24-, 40-, 48-I/O types only)	Diagram 14
Modbus master communication does not work. (24-, 40-, 48-I/O types only)	Diagram 15
Long communication cycle for Modbus RTU master communication or Modbus TCP client communication. (24-, 40-, 48-I/O types only)	Diagram 16
WindLDR and the SmartAXIS cannot communicate.	Diagram 17
WindLDR does not communicate with PLC via USB.	Diagram 18
Modbus master communication request is slow.	Diagram 19
Remote I/O Communication is not possible between the Remote I/O master and slaves.	Diagram 20

Troubleshooting Diagram 1

• SmartAXIS Lite - The Power/Run Status LED (PWR/RUN) is not On or Flashing

The SmartAXIS Lite power/run status LED (PWR/RUN) is on while running and flashes while stopped.

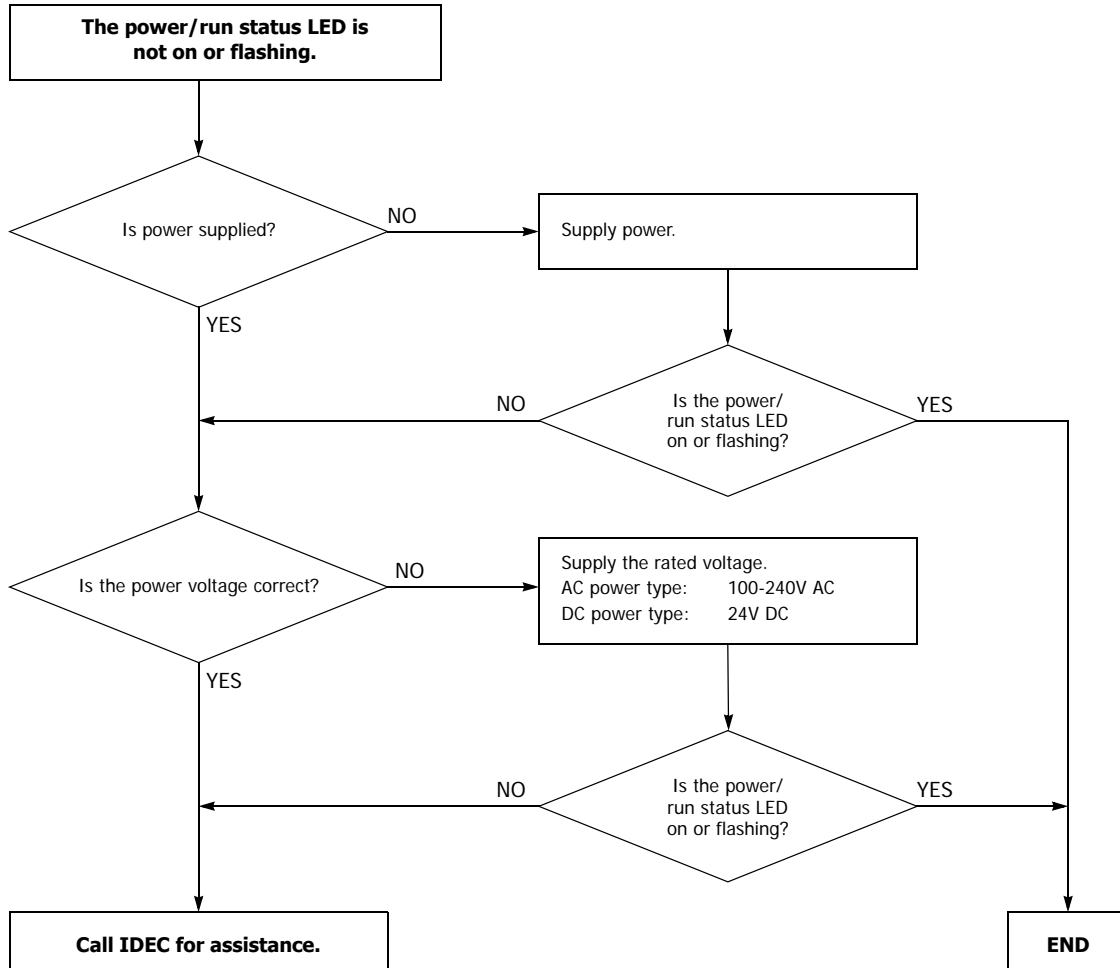

• SmartAXIS Pro - The Backlight is not On

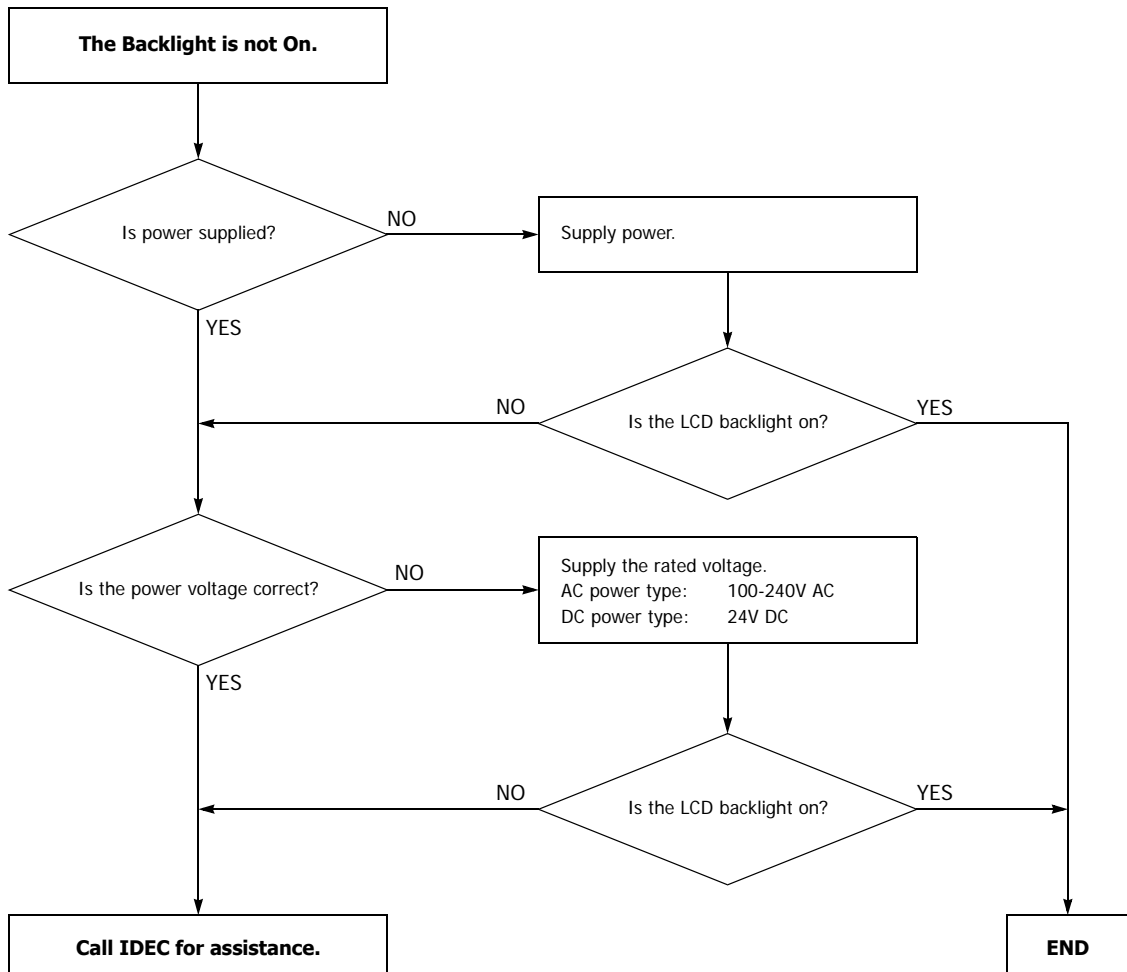

Troubleshooting Diagram 2

• SmartAXIS Lite - The Power/Run Status LED (PWR/RUN) is not On

The SmartAXIS Lite power/run status LED (PWR/RUN) is on while running and flashes while stopped.

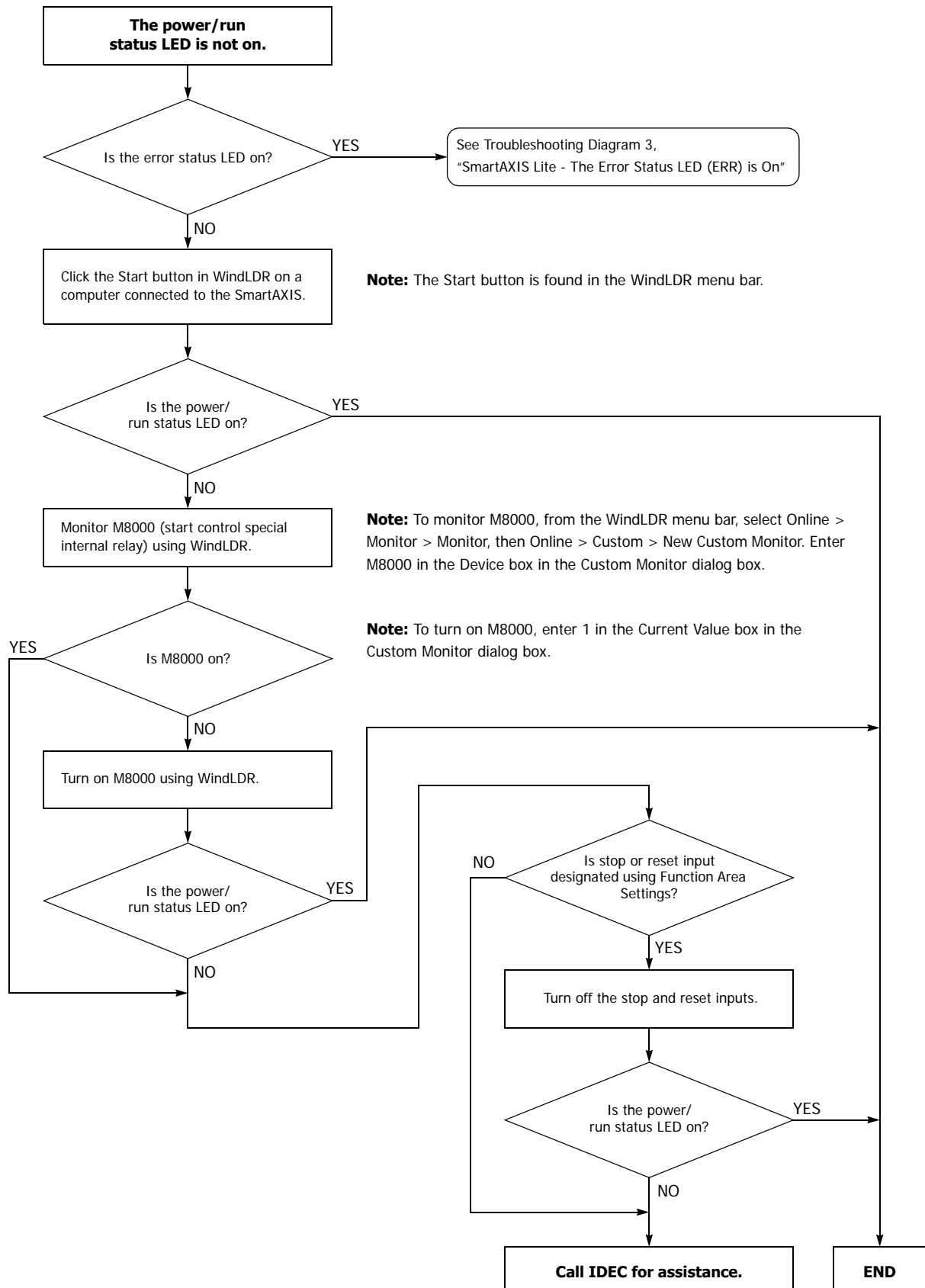

Troubleshooting Diagram 3

- **SmartAXIS Lite - The Error Status LED (ERR) is On**

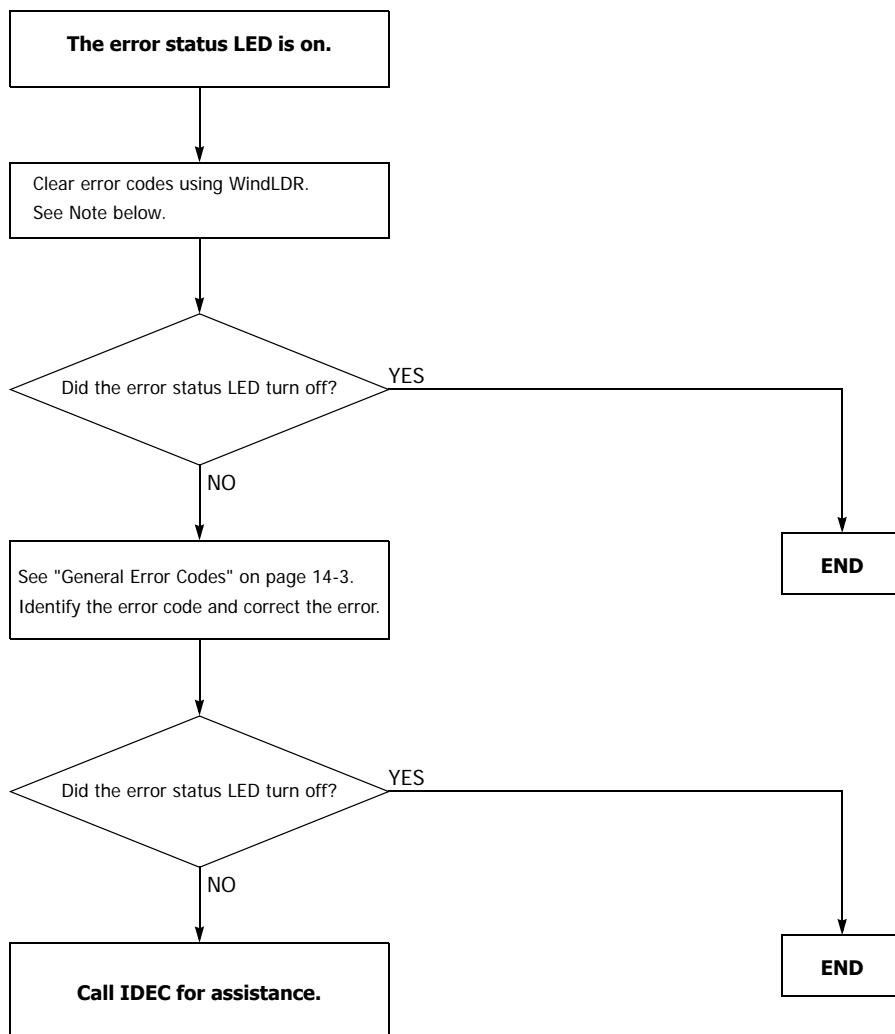

Note: Temporary errors can be cleared to restore normal operation by clearing error codes from WindLDR. See "Clearing Error Codes from WindLDR" on page 14-2.

Troubleshooting Diagram 4

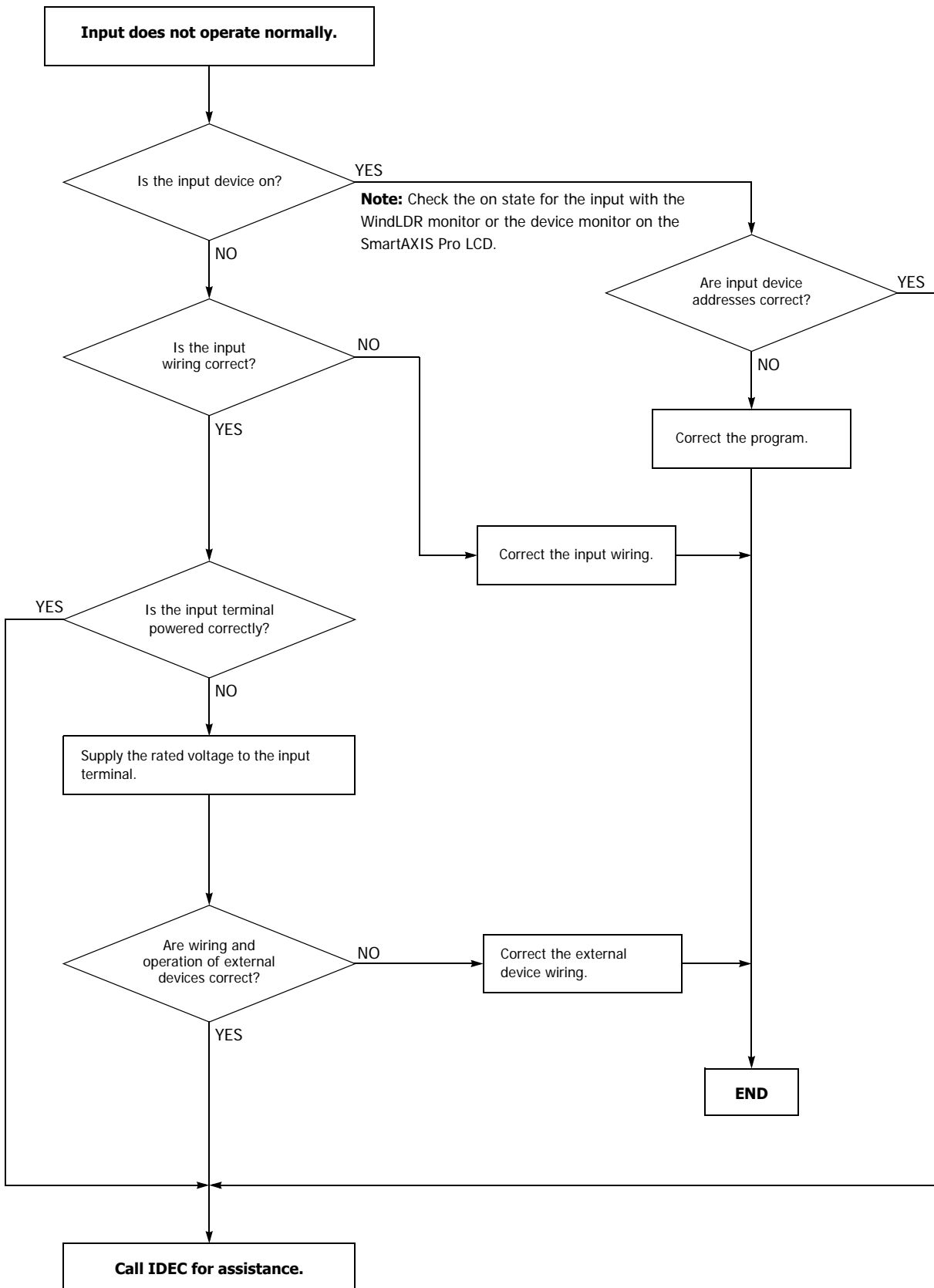

Troubleshooting Diagram 5

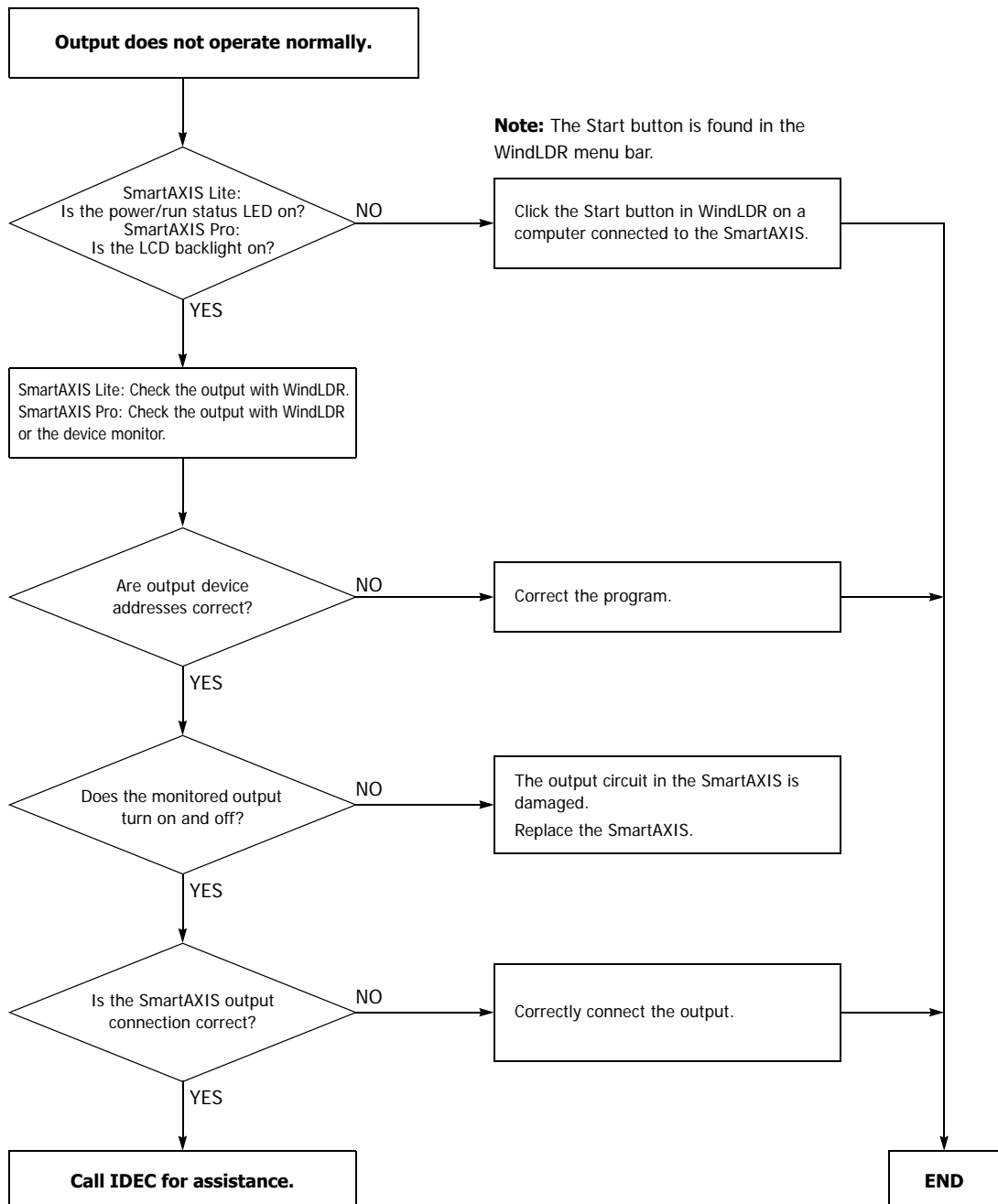

Troubleshooting Diagram 6

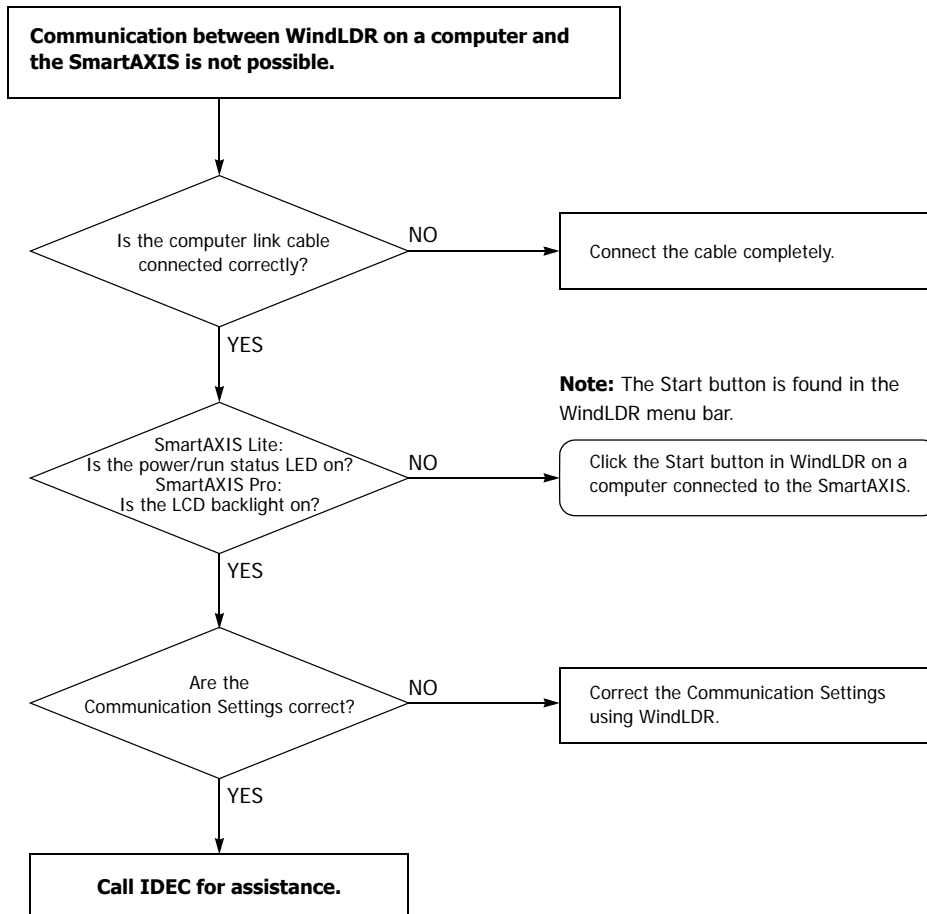

When only program download is not possible:

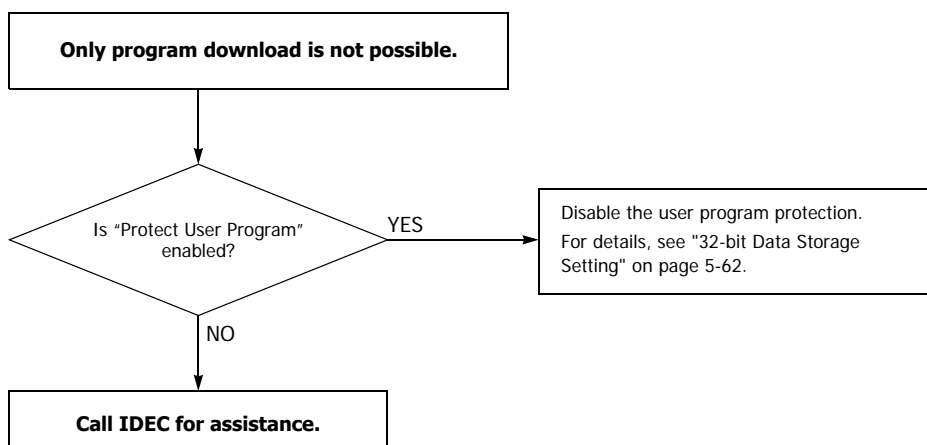

Troubleshooting Diagram 7

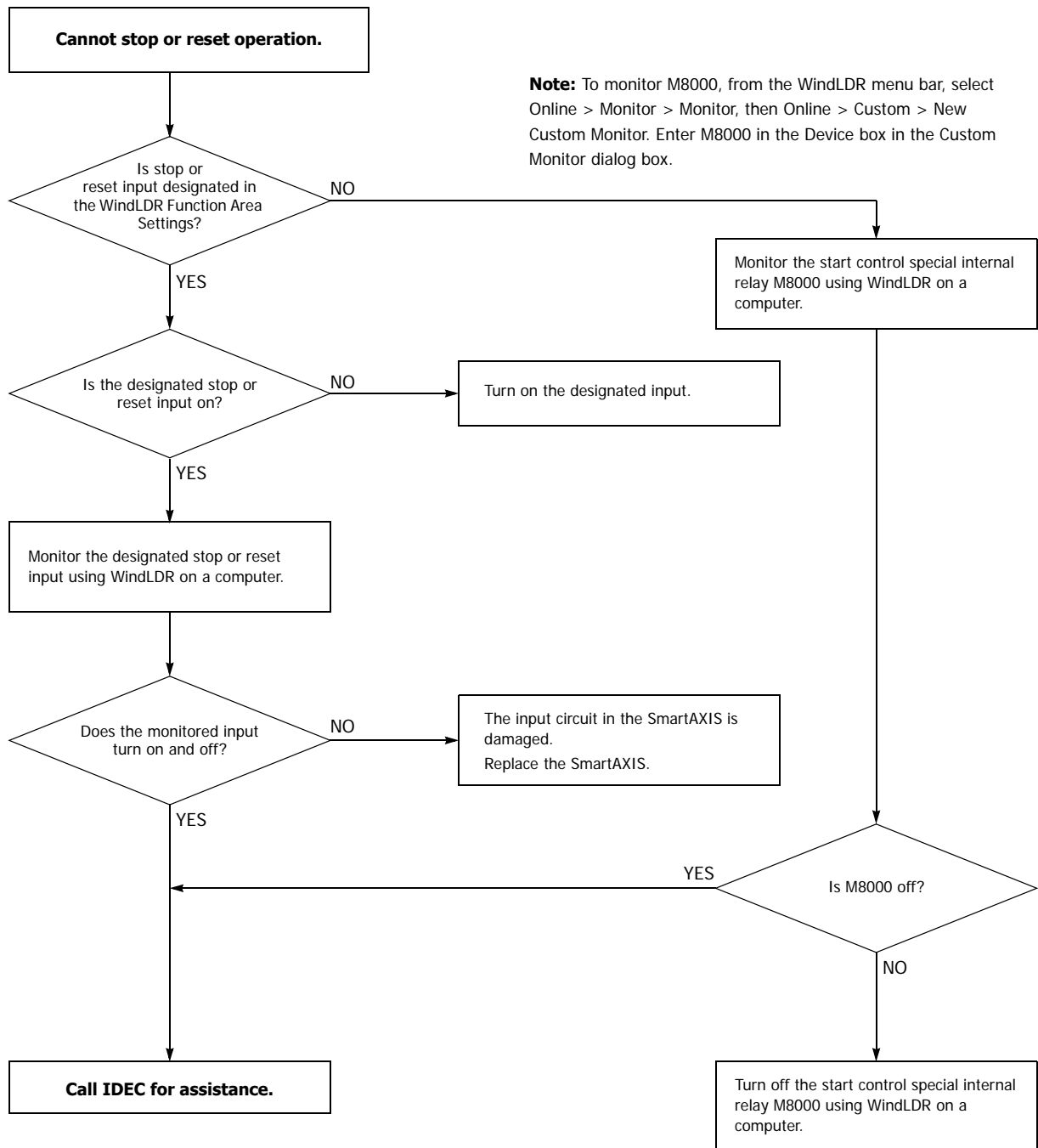

Note: To turn off M8000, enter 0 in the Current Value box in the Custom Monitor dialog box.

Troubleshooting Diagram 8

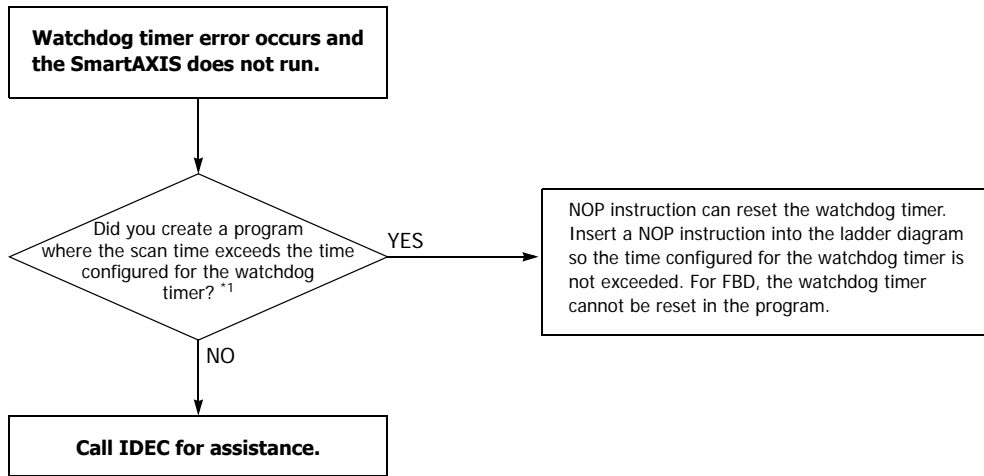

*1 See "Watchdog Timer Setting" on page 5-66.

Troubleshooting Diagram 9

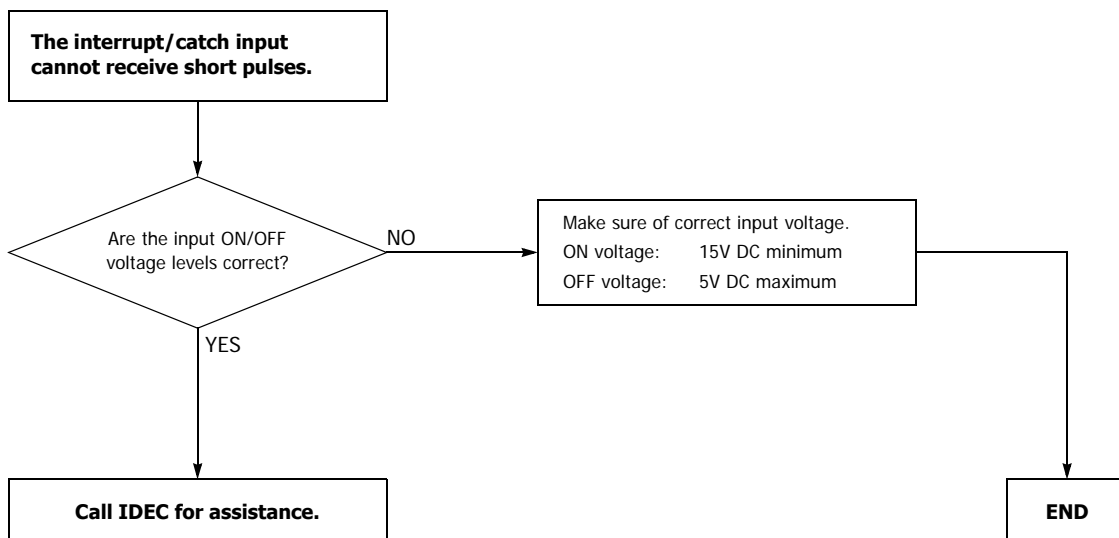

Troubleshooting Diagram 10

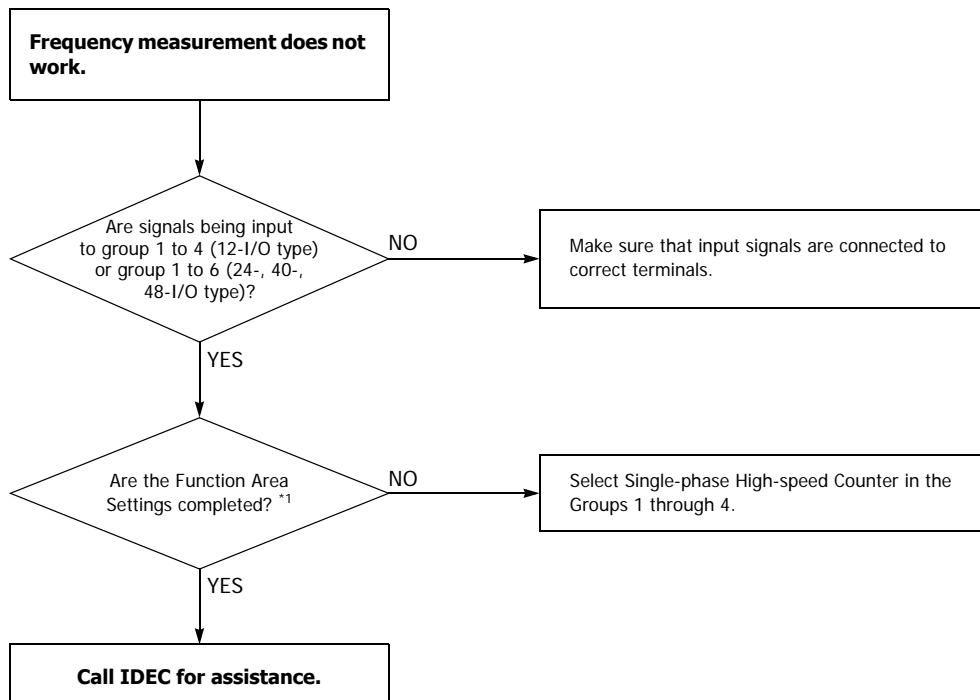

*1 See "Frequency Measurement" on page 5-36.

Troubleshooting Diagram 11

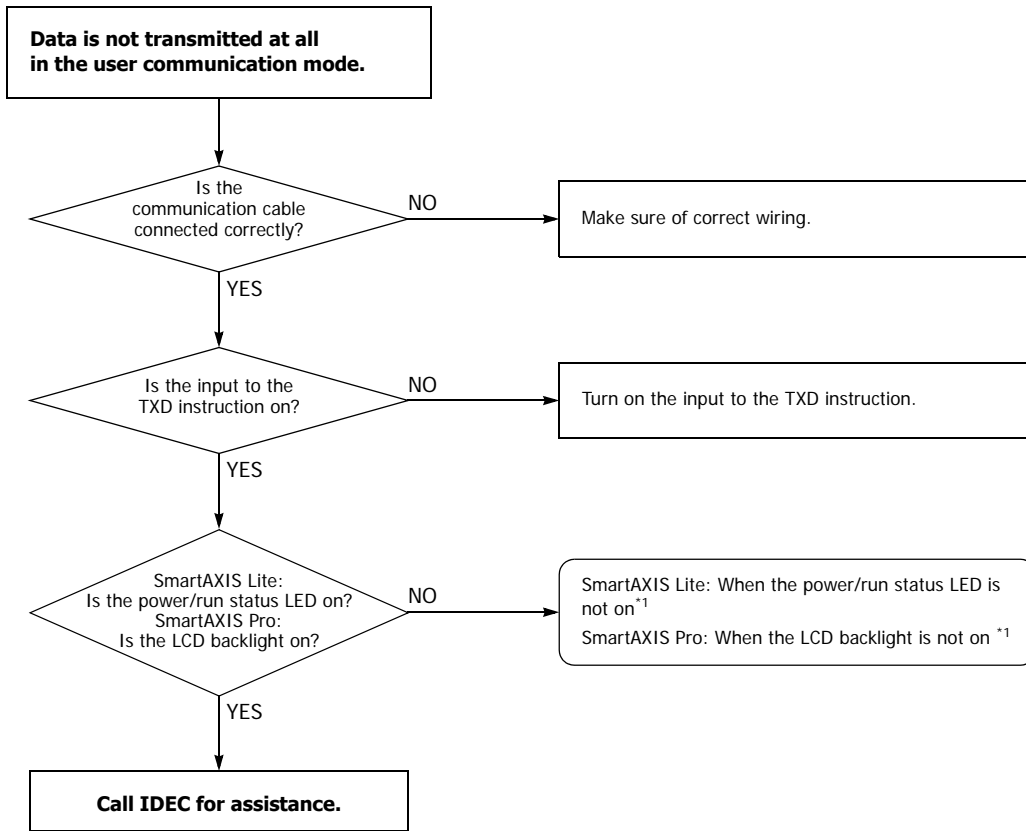

*1 "SmartAXIS Pro - The Backlight is not On" on page 14-9 or "SmartAXIS Lite - The Power/Run Status LED (PWR/RUN) is not On" on page 14-10.

Troubleshooting Diagram 12

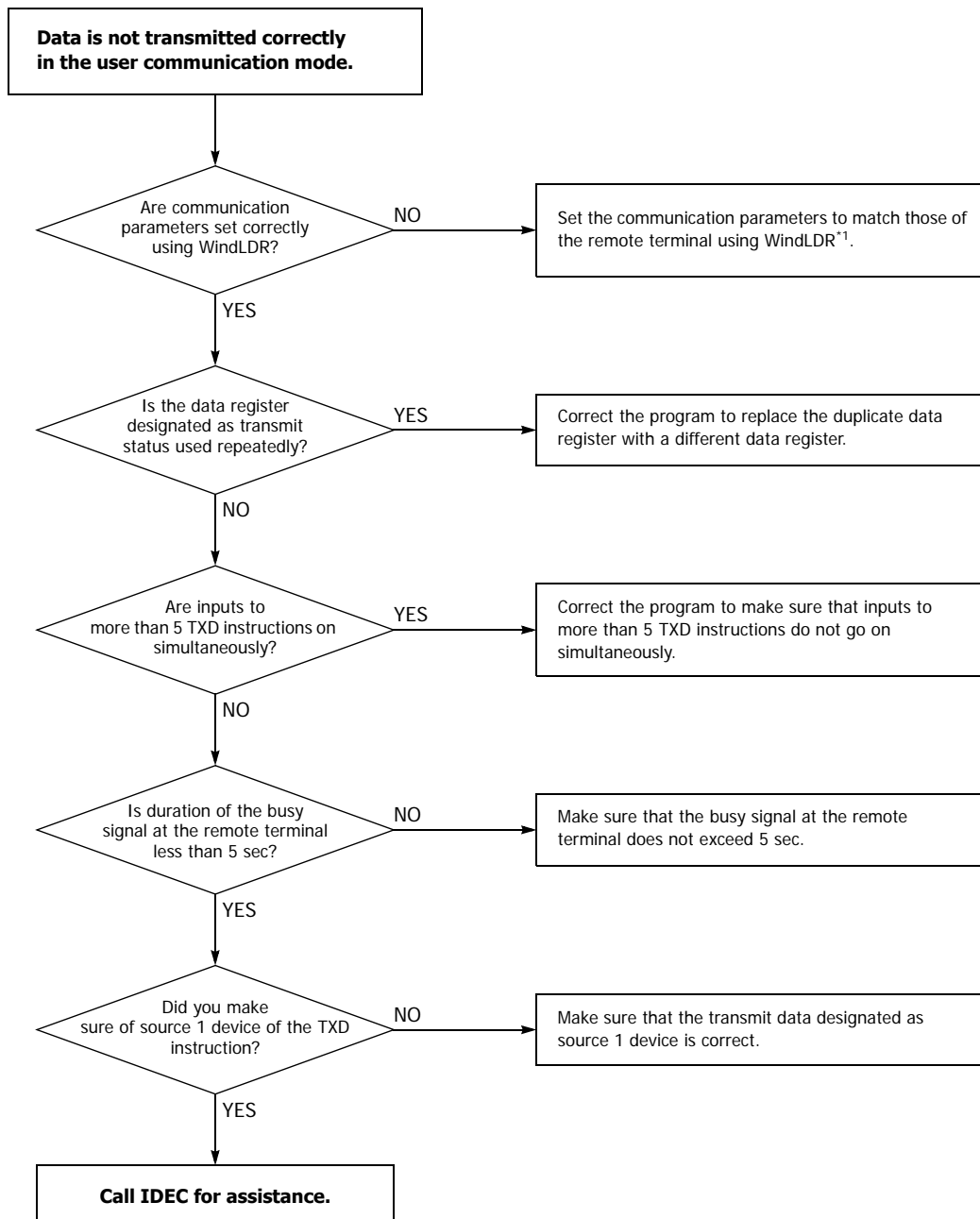

*1 See "Programming WindLDR" on page 10-4.

If the user communication still has a problem after completing the above procedure, also perform the procedure of Diagram 11, described on the preceding page.

Troubleshooting Diagram 13

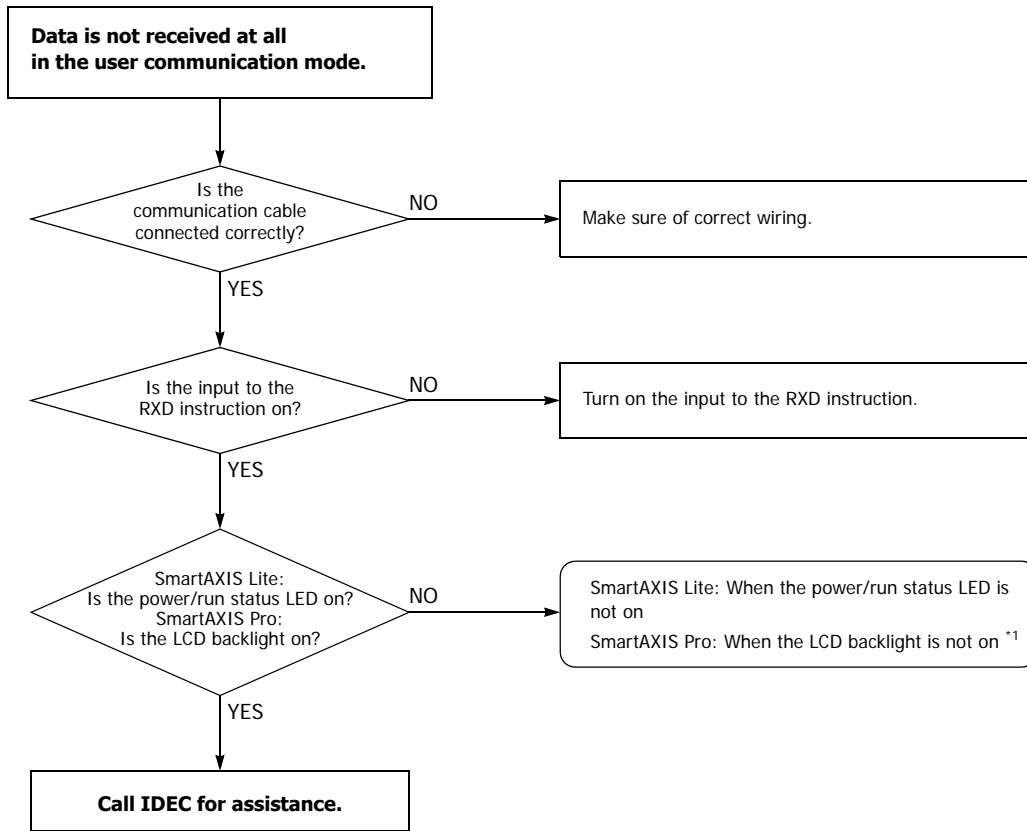

*1 See "SmartAXIS Pro - The Backlight is not On" on page 14-9 or "SmartAXIS Lite - The Power/Run Status LED (PWR/RUN) is not On" on page 14-10.

Troubleshooting Diagram 14

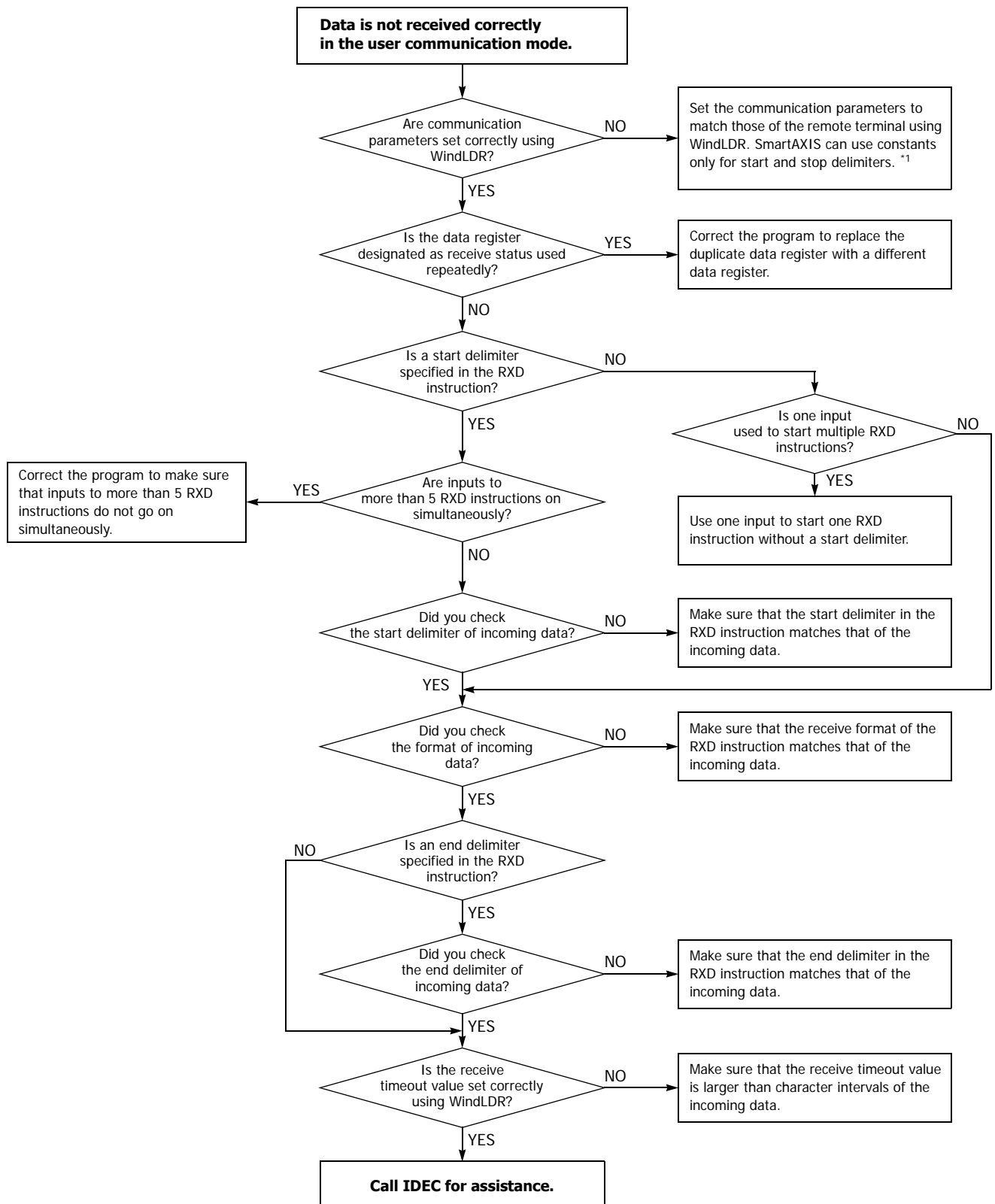

*1 See "Programming WindLDR" on page 10-4.

If the user communication still has a problem after completing the above procedure, also perform the procedure of Diagram 13 described on the preceding page.

Troubleshooting Diagram 15

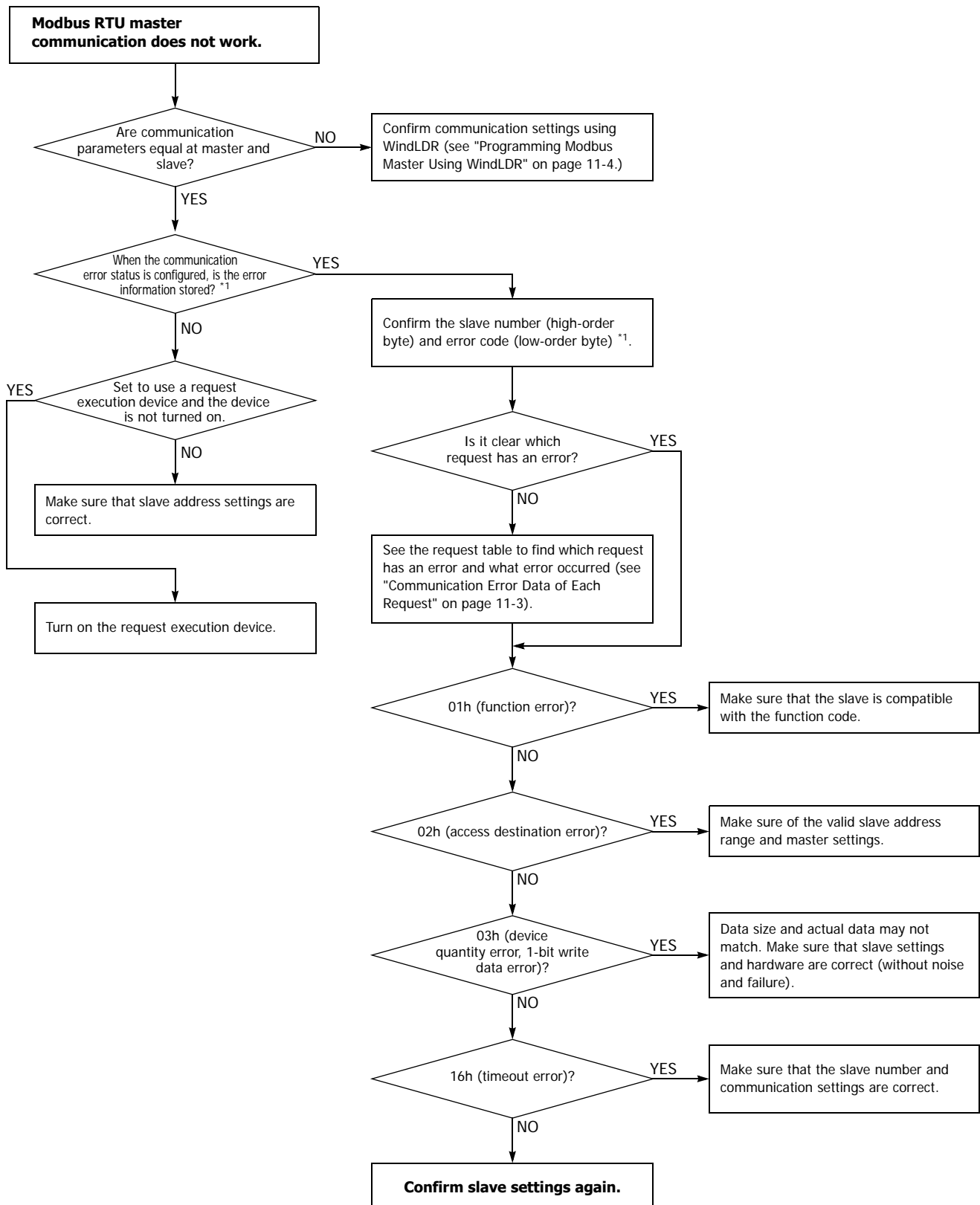

*1 See "Communication Error Data" on page 11-3.

Troubleshooting Diagram 16

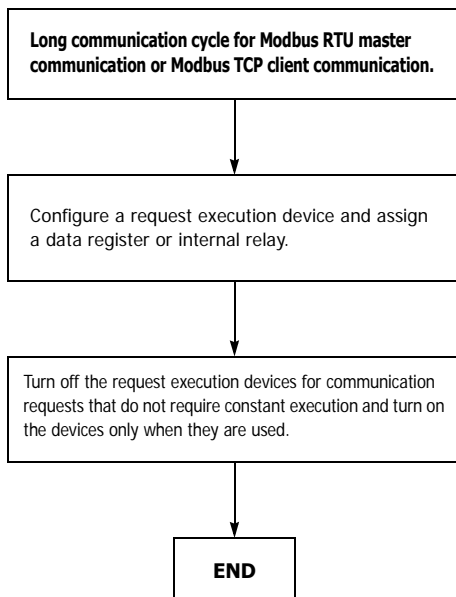

Troubleshooting Diagram 17

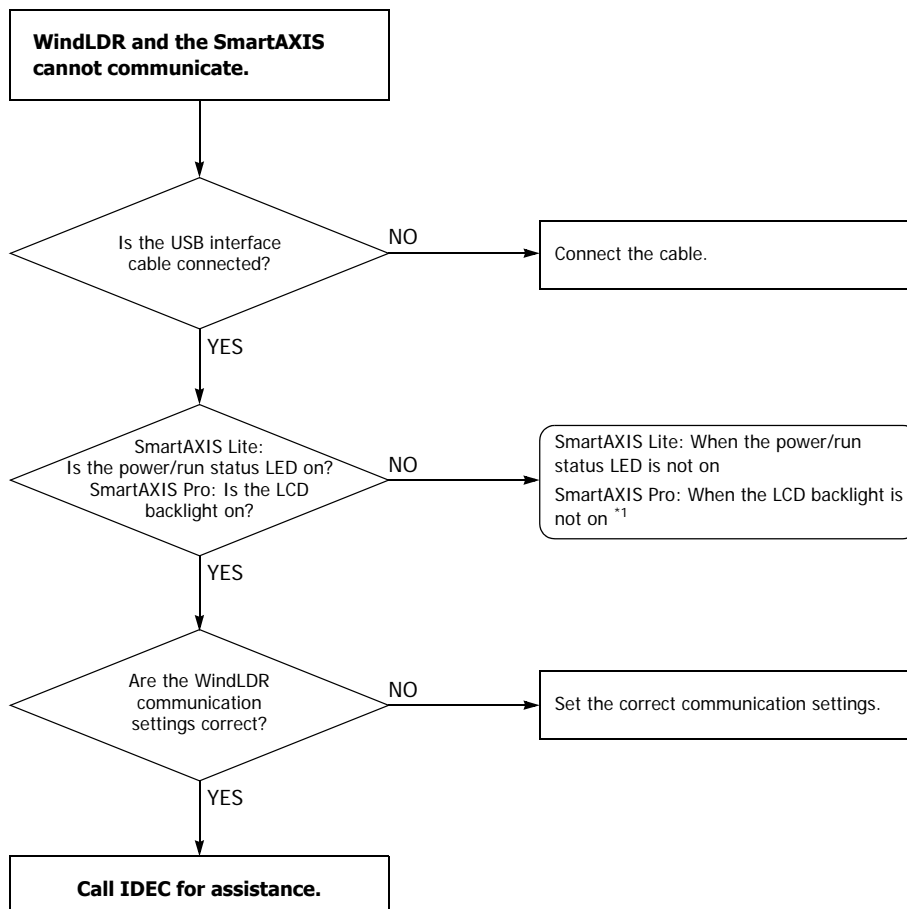

*1 See "SmartAXIS Pro - The Backlight is not On" on page 14-9 or "SmartAXIS Lite - The Power/Run Status LED (PWR/RUN) is not On" on page 14-10.

Troubleshooting Diagram 18

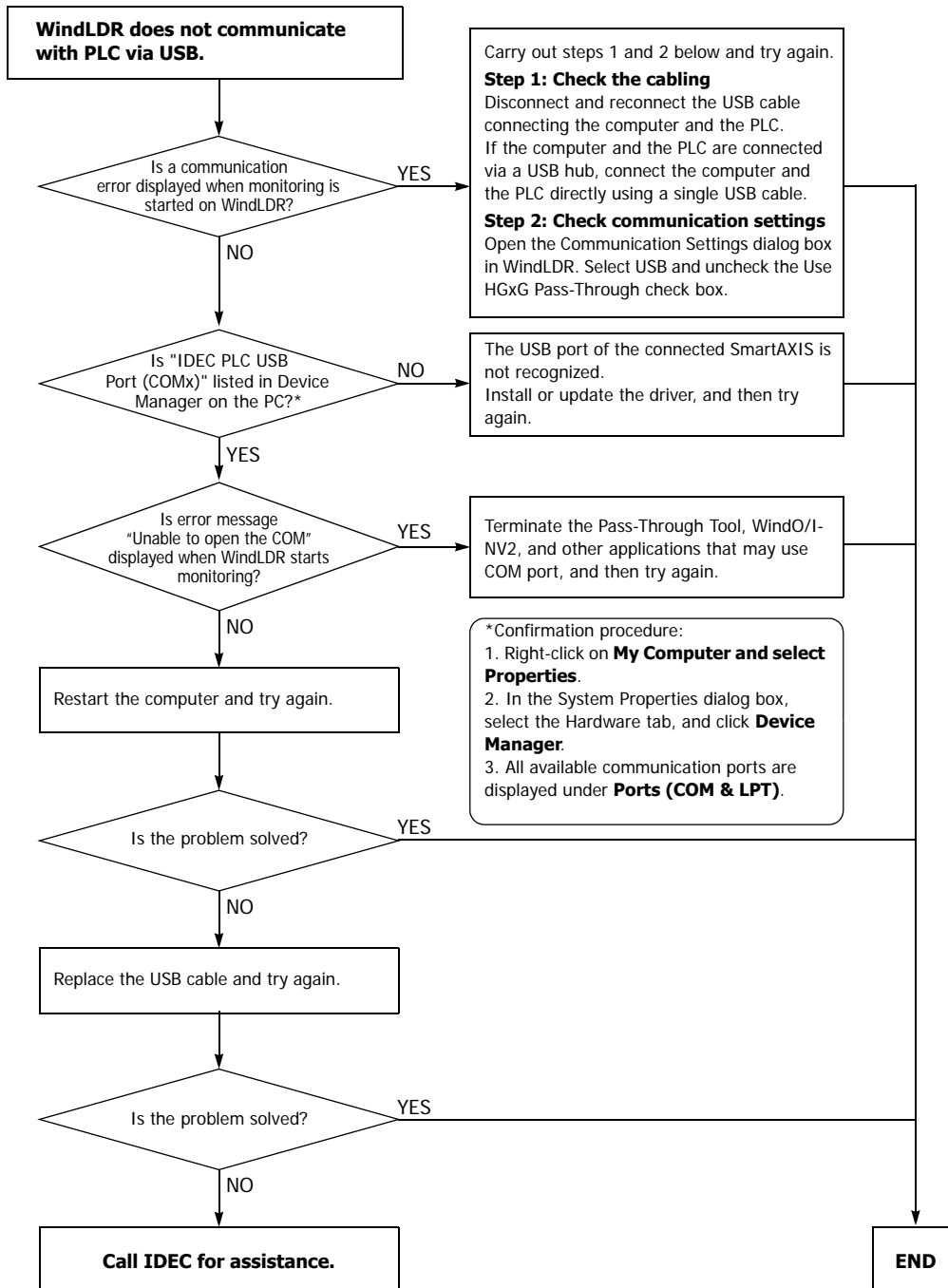

Troubleshooting Diagram 19

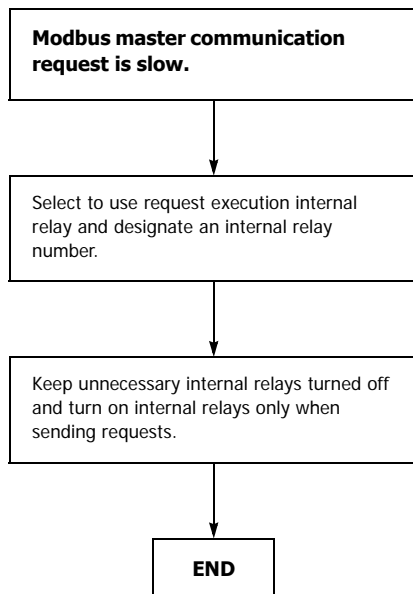

Troubleshooting Diagram 20

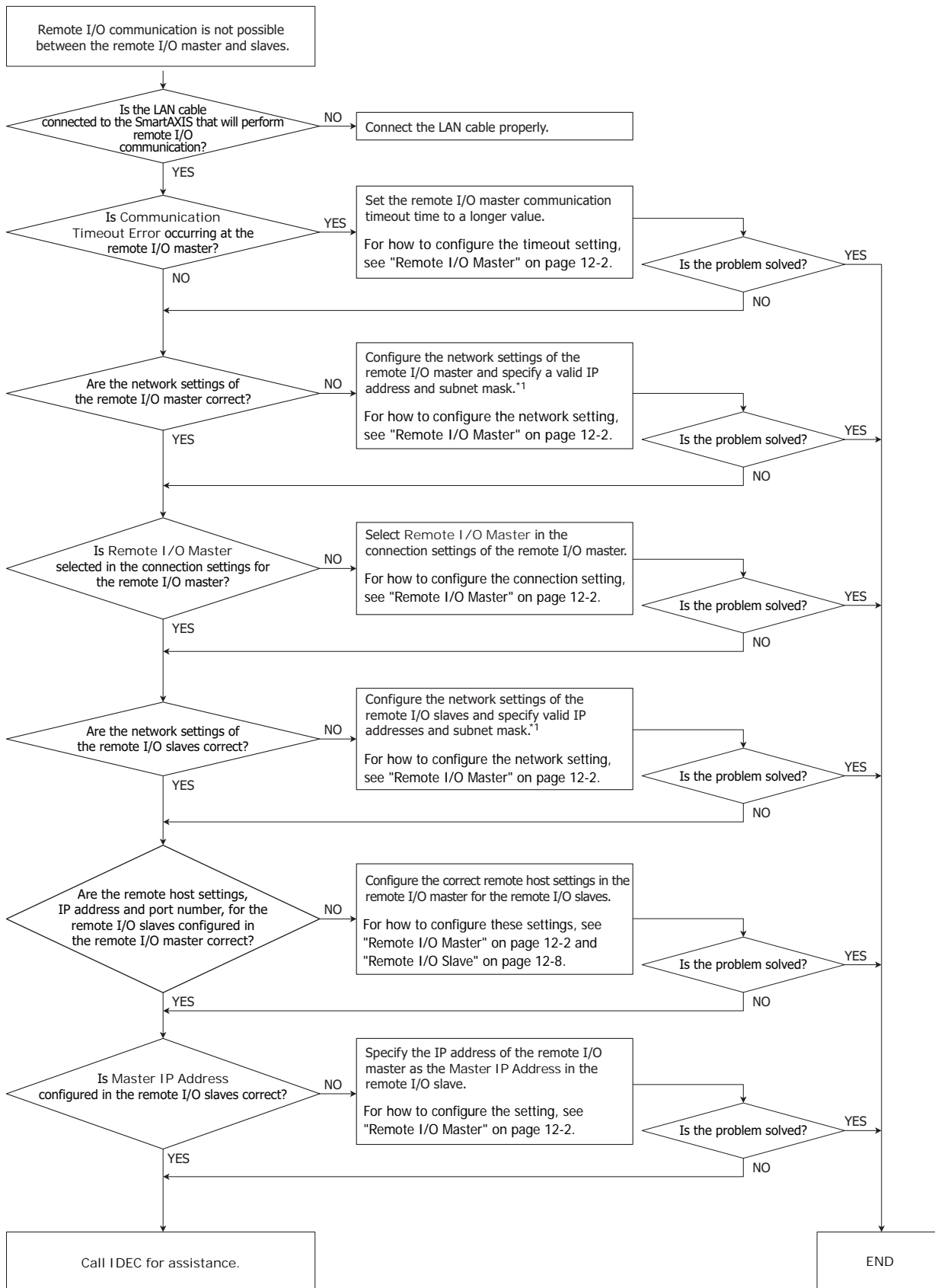

*1 Use valid network settings, IP address, subnet mask, and port number, for the remote I/O communication. For the valid network settings for the SmartAXIS, contact the network administrator.

APPENDIX

System Software

Getting the Latest Version of the System Software

When you install or upgrade to the latest version of Automation Organizer, the latest system software is also available along with the software.

Checking the Version

You can check the SmartAXIS system software version with the following steps.

1. Connect the computer to the SmartAXIS USB port with the USB maintenance cable (HG9Z-XCM42).
2. From the WindLDR menu bar, select **Online > Monitor > Start Monitor**.
WindLDR enters monitor mode.
3. Select **Online > PLC > Status**.
The PLC Status dialog box is displayed.

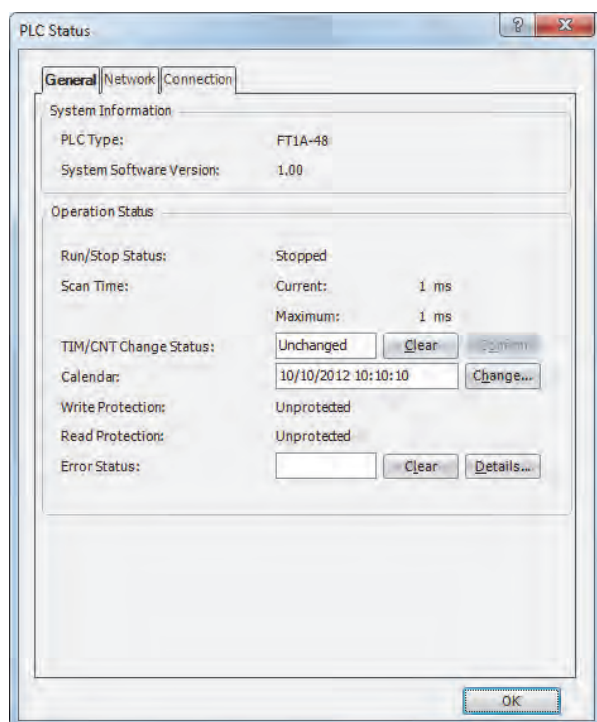

You can check the SmartAXIS system software version with **System Software Version**.

Note: SmartAXIS system software downloads can be executed from WindLDR.

For how to download the system software, see "Upgrade SmartAXIS System Software" on page A-2.

Upgrade SmartAXIS System Software

The system software of SmartAXIS can be upgraded using WindLDR. If the system software of your SmartAXIS is old, upgrade the system software with the following procedure:

1. Connect the SmartAXIS to the computer where WindLDR is installed using USB maintenance cable (recommended cable: HG9Z-XCM42).

Note: System software cannot be downloaded via the expansion communication ports or the Ethernet port.

2. From the WindLDR menu bar, select **Online > Download > System Software Download**.

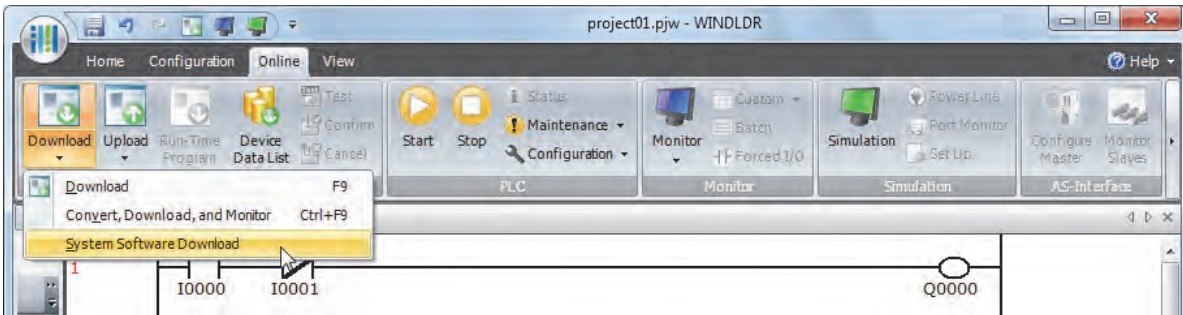

The System Software Download dialog box appears.

3. Select the PLC type and the system software version to download, and then click **Start System Software Download**.

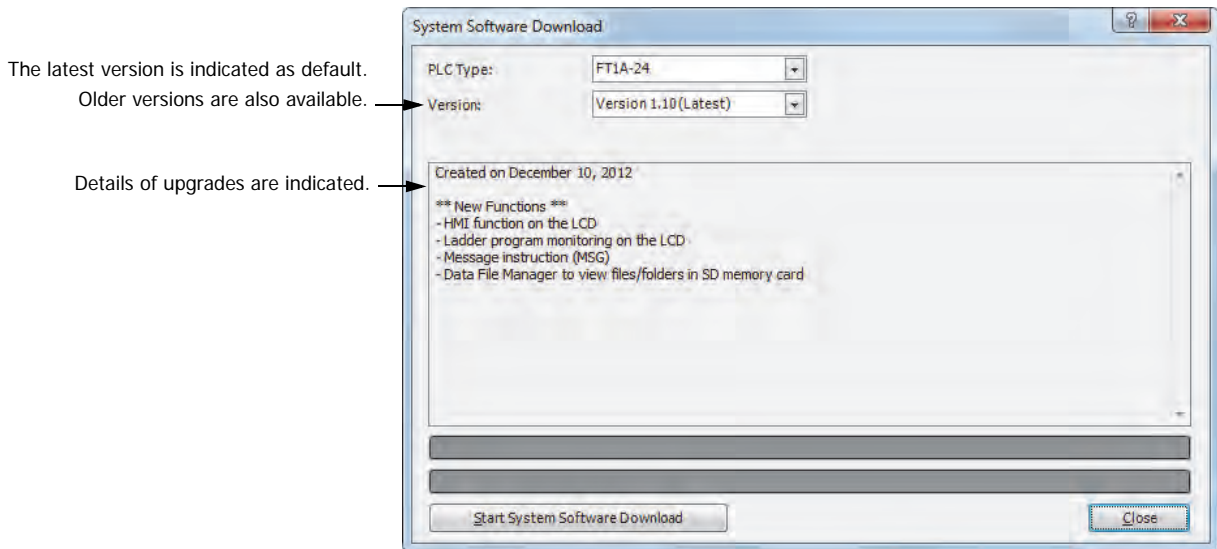

Notes:

- If the SmartAXIS is running, it is stopped automatically before the system software download starts.
- Older system software can also be downloaded to the SmartAXIS if required.
- The system software download takes about one minute.

4. A confirmation message is displayed. Click **OK** to start downloading the system software.

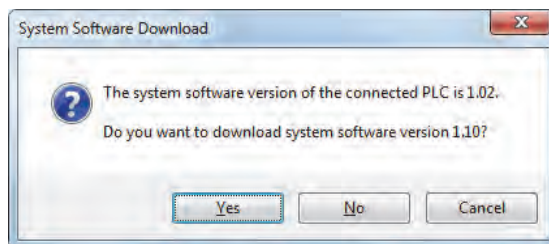

5. System software download status is shown by a progress bar. A completion message appears when the system software has been downloaded successfully. Click **OK** to close the System Software Download dialog box.

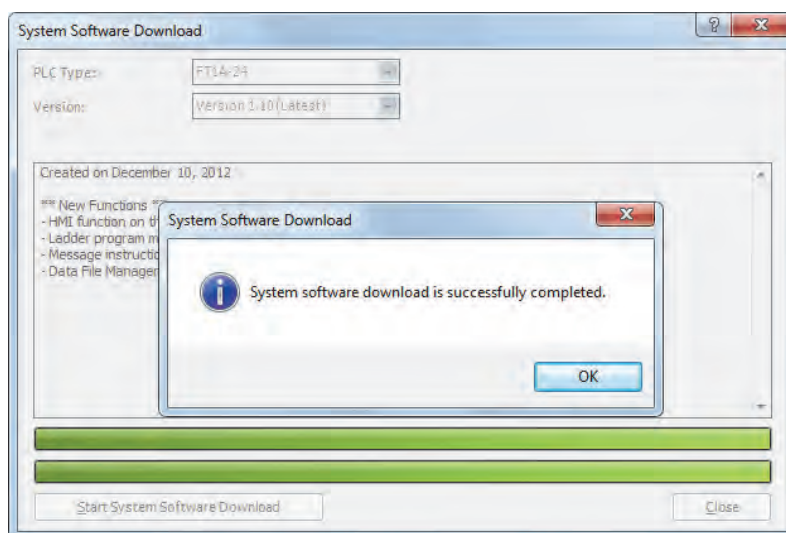

Notes:

- For the SmartAXIS Pro, its backlight will flash while the system software is downloading. For the SmartAXIS Lite, its error status LED will flash.
- After the system software has downloaded, the SmartAXIS will be in the STOP state. Start the SmartAXIS with WindLDR or the SmartAXIS Pro LCD/operation switches.
- The user program stored in the SmartAXIS before downloading the system software remains and is executed when the SmartAXIS is restarted. A user program execution error may occur if an older system software is downloaded to the SmartAXIS.
- If the system software download fails, the backlight on the SmartAXIS Pro will remain flashing or the error status LED on the SmartAXIS Lite will remain flashing. In this situation, turn on the SmartAXIS power again and redo the download from step 1. If the SmartAXIS Pro backlight is still flashing or the SmartAXIS Lite error status LED is still flashing even after turning on the power again, the communication error dialog box is displayed before step 4.

1. A communication error dialog box is displayed. Click **Cancel**.

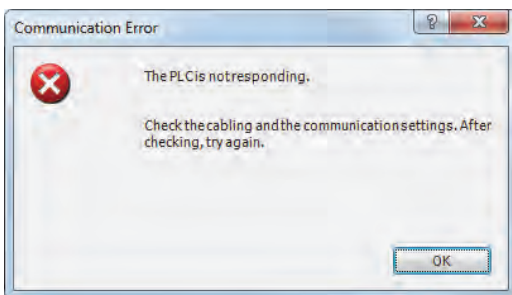

2. A dialog box prompting you to check the status of the SmartAXIS is displayed. Click **Yes**.

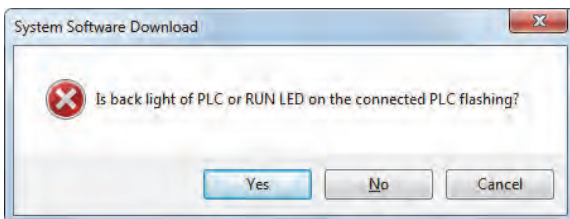

USB Driver Installation Procedure

Installing on Windows XP

1. Connect a USB cable to the USB port on the SmartAXIS (with power supplied) while the computer is running.
2. After the message "Found New Hardware" appears on the computer, the driver installation wizard appears. Select **No, not this time** and click **Next**.

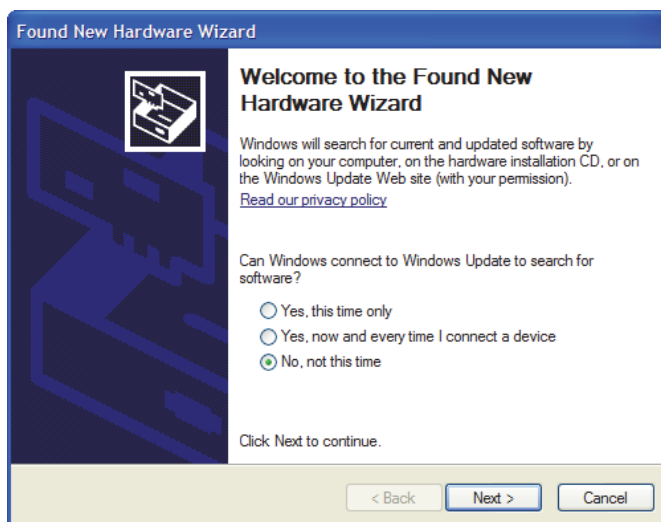

3. Select **Install the software automatically (Recommended)** and click **Next**.

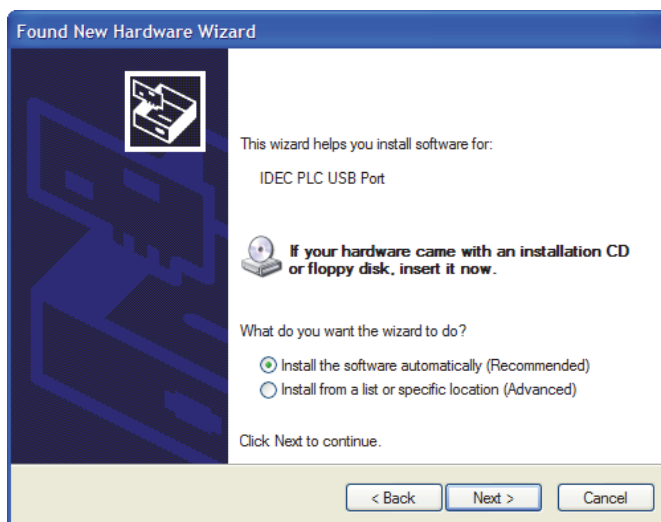

4. Click **Continue Anyway** button.



If the installation is aborted without showing the dialog box above, **Block** is selected in the Driver Signing Options in **Driver Signing** in the **System Properties** dialog box. If the installation is aborted, this option should be changed to **Warn**. After changing the option to **Warn**, reconnect the SmartAXIS and retry the installation procedure from the step 1.

5. Installation is now complete. Click **Finish**.

Installing on Windows Vista/7 (32-bit or 64-bit)

1. Connect a USB cable to the USB port on the SmartAXIS with the power supplied and the computer running.
2. The following message appears in the bottom right corner of the desktop.

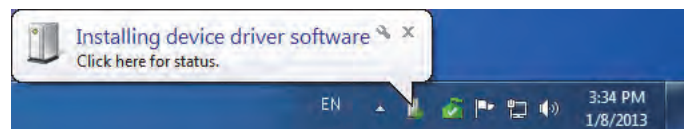

3. The installation is complete once the message "Your device is ready to use" appears in the bottom right corner of the desktop.

Installing on Windows 8 (32-bit or 64-bit)

1. Connect a USB cable to the USB port on the SmartAXIS with the power supplied and the computer running.
2. An icon is displayed in the taskbar. Click to display the progress dialog.

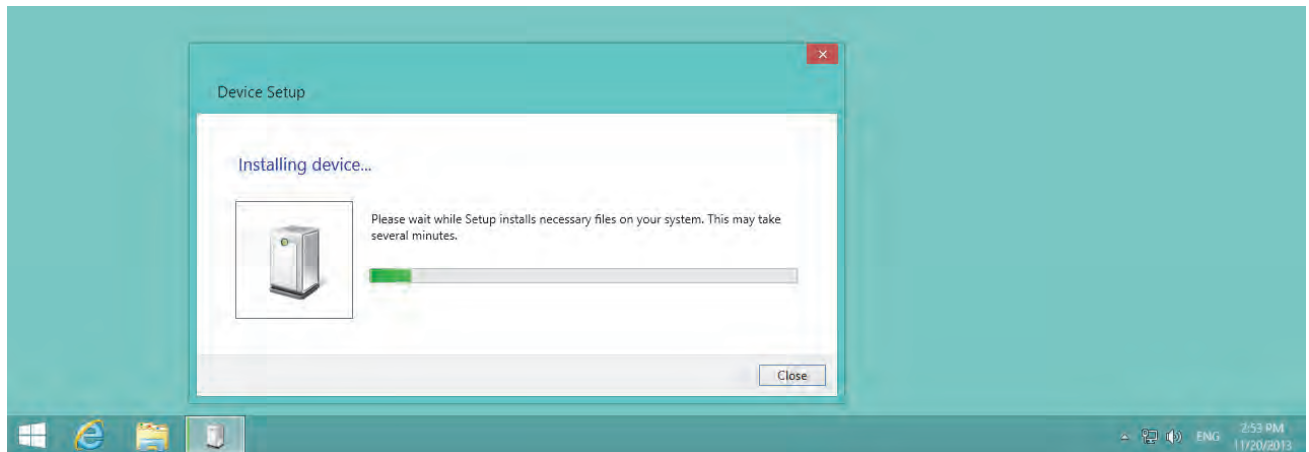

3. When the installation is complete, the icon in the taskbar automatically disappears. The installation is completed.

Cables

Communication cables and their connector pinouts are described in this section.

Communication Port and Applicable Cables

Communication Port	Communication Cartridge	Applicable Cable
Expansion Communication Port 2 Expansion Communication Port 3	RS232C communication cartridge FT1A-PC1 (Mini-DIN type)	FC2A-KC4C FC2A-KP1C HG9Z-XC295 FC4A-KC1C FC4A-KC2C
	RS485 communication cartridge FT1A-PC2 (Mini-DIN type)	FC2A-KP1C
	RS485 communication cartridge FT1A-PC3 (Terminal block type)	Twisted-pair shielded cable with a minimum core wire of 0.3mm ² (Conductor resistance 85Ω/km maximum, shield resistance 20Ω/km maximum)

Computer Link Cable 4C (FC2A-KC4C)

Cable Length: 3m (9.84 feet)

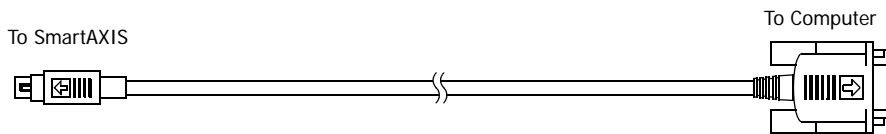

Mini DIN Connector Pinouts

Description	Pin
Shield	Cover
TXD Transmit Data	3
RXD Receive Data	4
RTS Request to Send	1
NC No Connection	8
DSR Data Set Ready	5
DTR Data Terminal Ready	2
SG Signal Ground	7
SG Signal Ground	6

D-sub 9-pin Female Connector Pinouts

Pin	Description
Cover	FG Frame Ground
3	TXD Transmit Data
2	RXD Receive Data
6	DSR Data Set Ready
8	CTS Clear to Send
1	DCD Data Carrier Detect
4	DTR Data Terminal Ready
5	SG Signal Ground
7	NC No Connection
9	NC No Connection

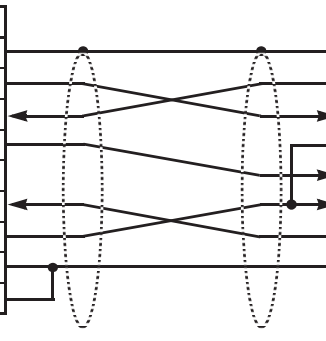

User Communication Cable 1C (FC2A-KP1C)

Cable Length: 2.5m (8.2 feet)

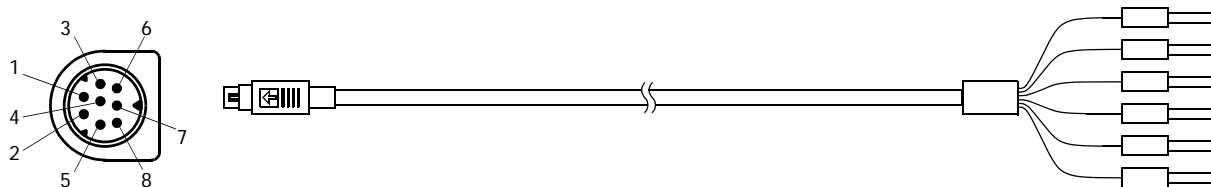

Mini DIN Connector Pinouts

Pin	Signal line (RS232C)		Signal line (RS485)		AWG#	Color	Signal Direction
1	RTS	Request to Send	B		28 Twisted	Black	→
2	DTR	Data Terminal Ready	A			Yellow	
3	TXD	Transmit Data	NC	No Connection	28	Blue	→
4	RXD	Receive Data	NC	No Connection	28	Green	←
5	DSR	Data Set Ready	NC	No Connection	28	Brown	←
6	SG	Signal Ground	NC	No Connection	28	Gray	
7	SG	Signal Ground	SG	Signal Ground	26 Twisted	Red	
8	NC	No Connection	NC	No Connection		26	White
Cover	—		—		—	Shield	

Caution • Do not connect any wiring to NC terminals, otherwise operation failure or device damage may be caused.

O/I Communication Cable (HG9Z-XC295)

Cable Length: 5m (16.4 feet)



D-sub 9-pin Female Connector Pinouts

Description	Pin
RS	1
ER	2
SD	3
RD	4
DR	5
SG	6
SG	7
NC	8
Shield	Cover

Mini DIN Connector Pinouts

Pin	Description
2	RD
3	SD
5	SG
7	RS
8	CS
Cover	Shield

O/I Communication Cable 1C (FC4A-KC1C)

Cable Length: 5m (16.4 feet)

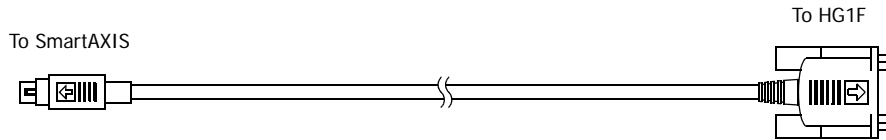

Mini DIN Connector Pinouts

Description	Pin	
NC	No Connection	1
NC	No Connection	2
TXD	Transmit Data	3
RXD	Receive Data	4
NC	No Connection	5
SG	Signal Ground	6
SG	Signal Ground	7
NC	No Connection	8
Shield	Cover	

D-sub 9-pin Male Connector Pinouts

Pin	Description
1	FG Frame Ground
2	TXD1 Transmit Data 1
3	RXD1 Receive Data 1
4	TXD2 Transmit Data 2
5	RXD2 Receive Data 2
6	DSR Data Set Ready
7	SG Signal Ground
8	NC No Connection
9	DTR Data Terminal Ready

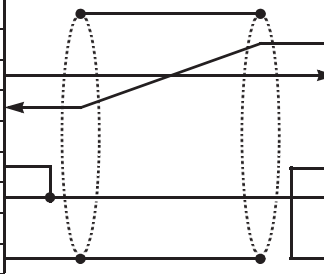

O/I Communication Cable 2C (FC4A-KC2C)

Cable Length: 5m (16.4 feet)

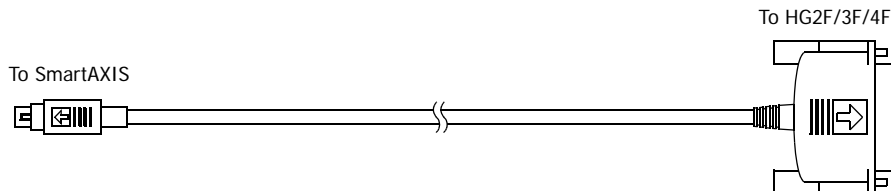

Mini DIN Connector Pinouts

Description	Pin	
NC	No Connection	1
NC	No Connection	2
TXD	Transmit Data	3
RXD	Receive Data	4
NC	No Connection	5
CMSW	Communication Switch	6
SG	Signal Ground	7
NC	No Connection	8
Shield	Cover	

D-sub 25-pin Male Connector Pinouts

Pin	Description
1	FG Frame Ground
2	TXD Transmit Data
3	RXD Receive Data
4	RTS Request to Send
5	CTS Clear to Send
6	DSR Data Set Ready
7	SG Signal Ground
8	DCD Data Carrier Detect
20	DTR Data Terminal Ready

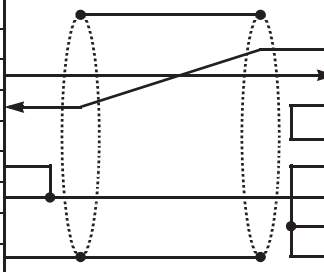

HMI Screen Transition Diagram

System menu overall transition diagram

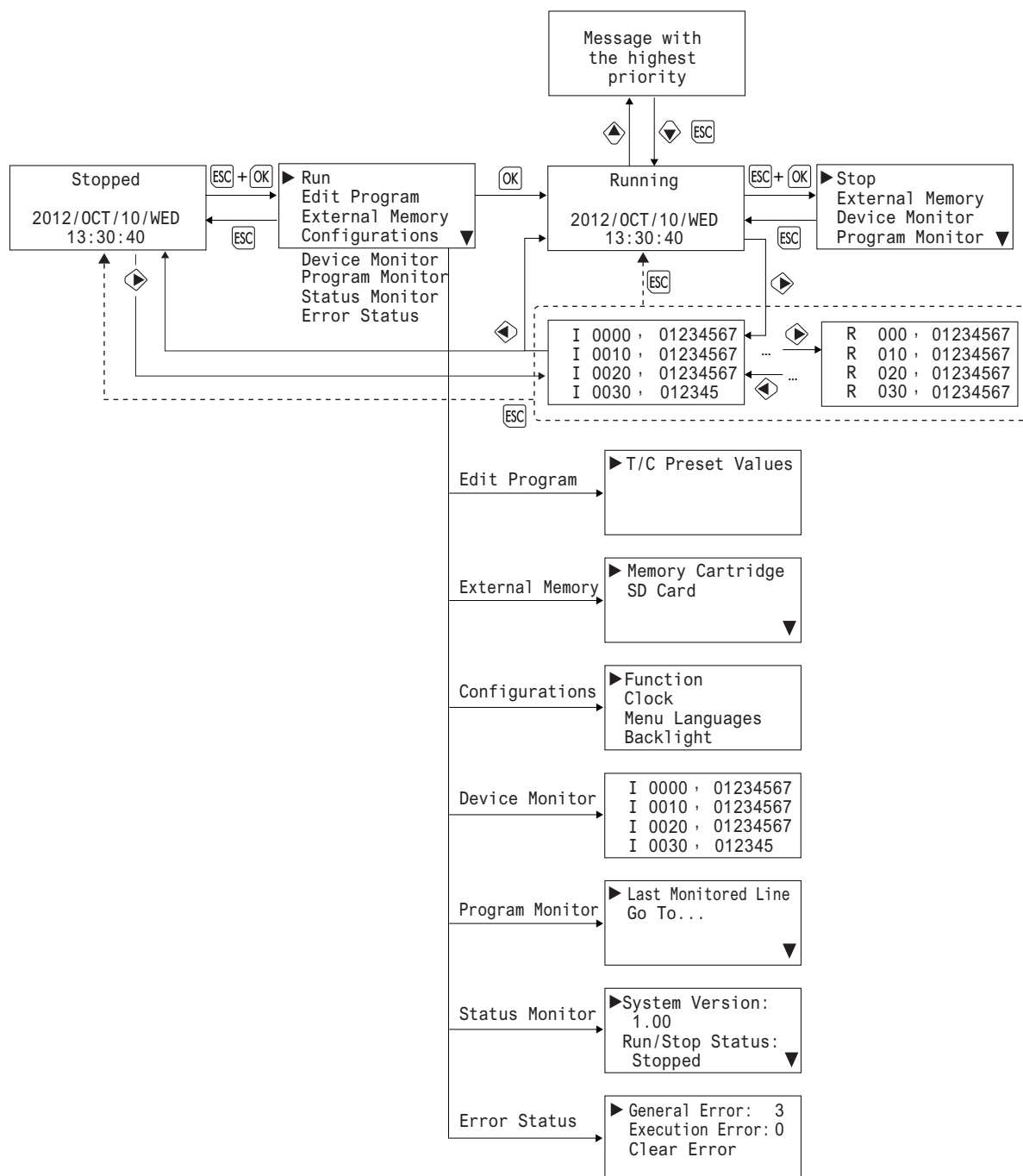

Switching run/stop

Running the SmartAXIS

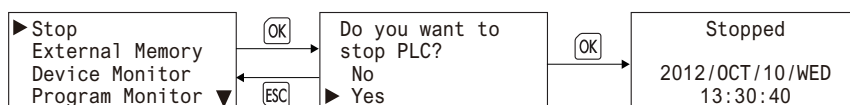

Stopping the SmartAXIS

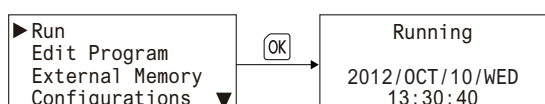

Writing/Clearing TP (Timer Preset Values) and CP (Counter Preset Values) in the User Program

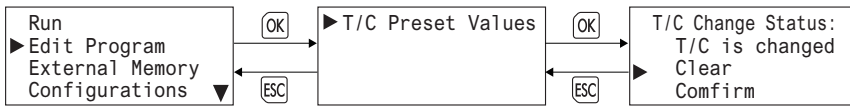

Uploading/Downloading the User Program

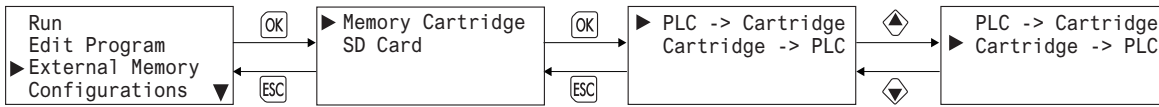

Stopping Access to the SD Memory Card/Formatting the SD Memory Card

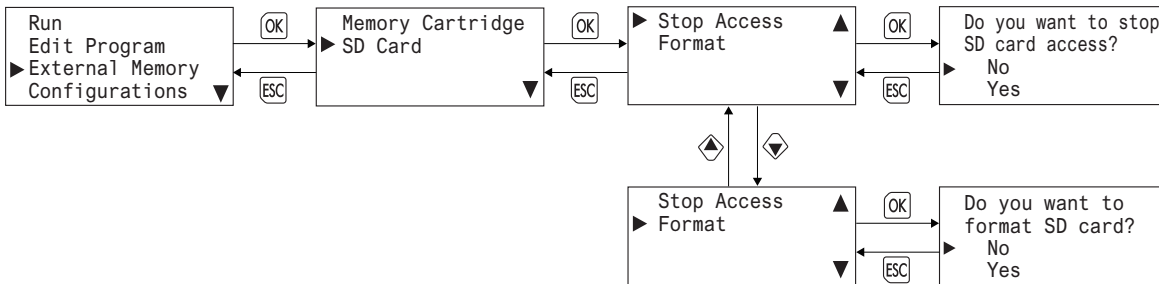

Configuring the Slave Number

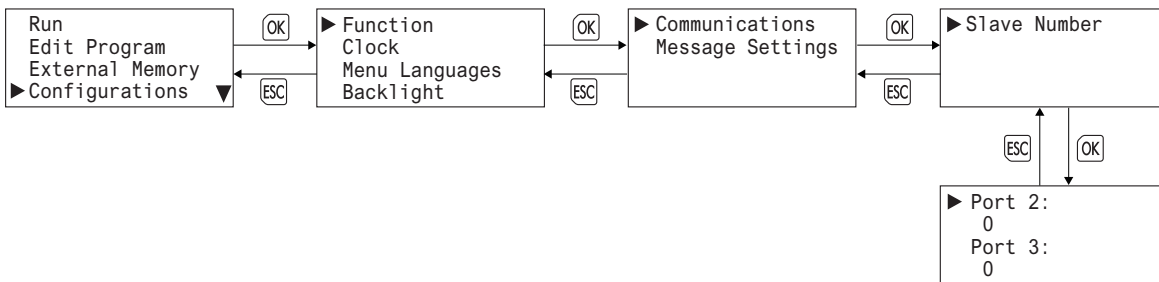

Configuring the Network Settings

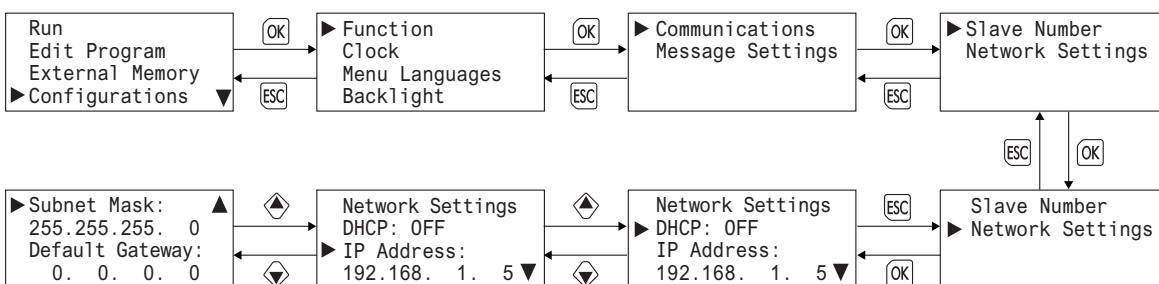

Modifying the Scroll Speed/Configuring the Scroll Unit

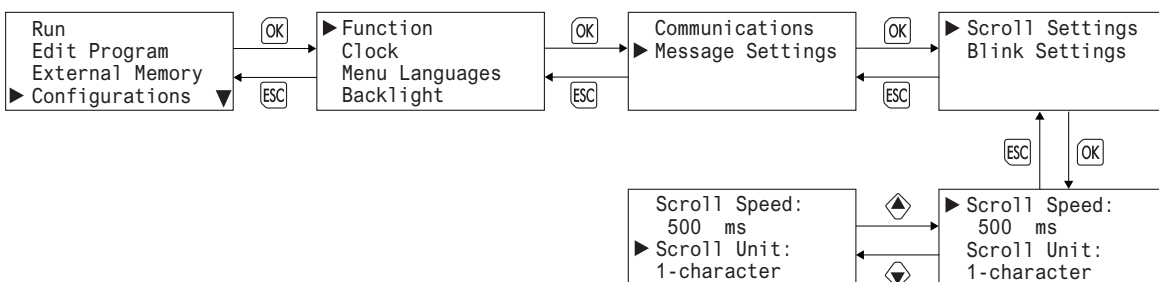

Configuring the Blinking Speed

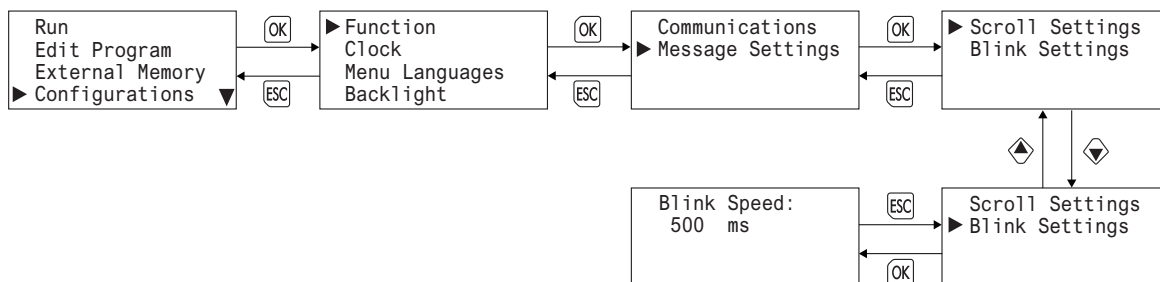

Setting the Calendar/Clock

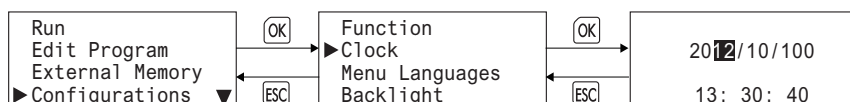

Changing the Menu Language

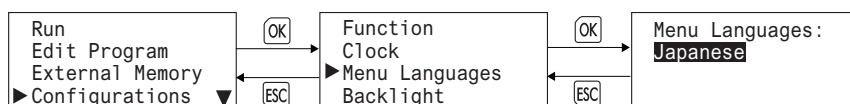

Setting the LCD Backlight ON Time

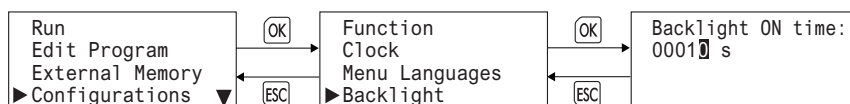

Monitoring Device Values

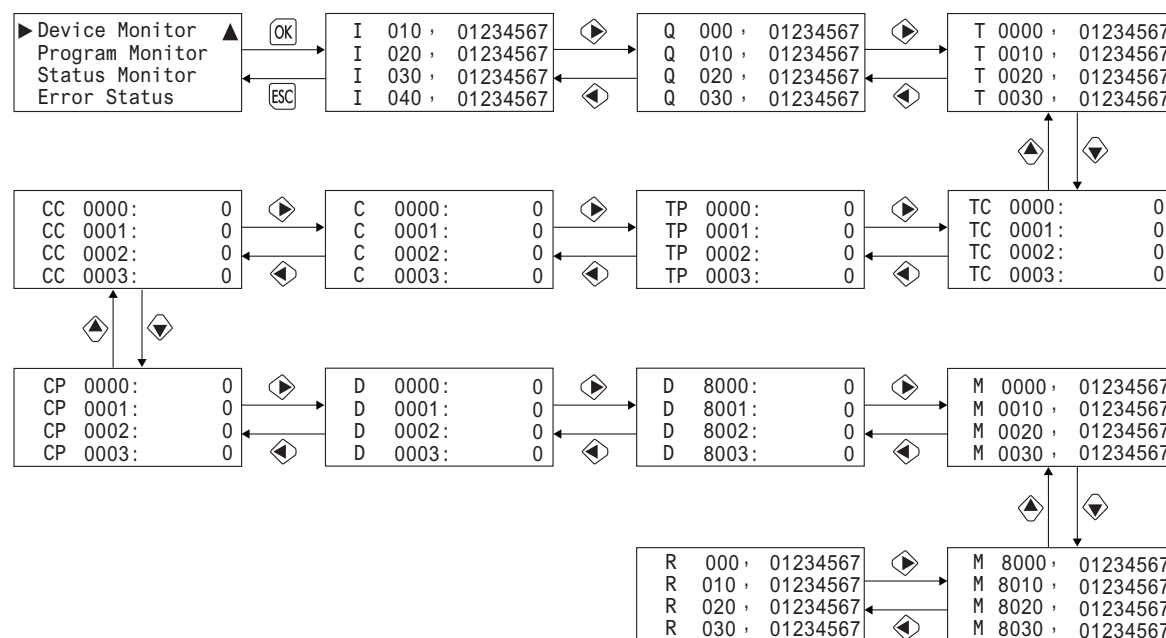

Monitoring the User Program

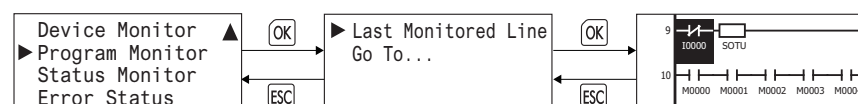

When FBD program is selected as the programming language, **Program Monitor** and the System Menu items under it are not displayed.

Monitoring the SmartAXIS Status

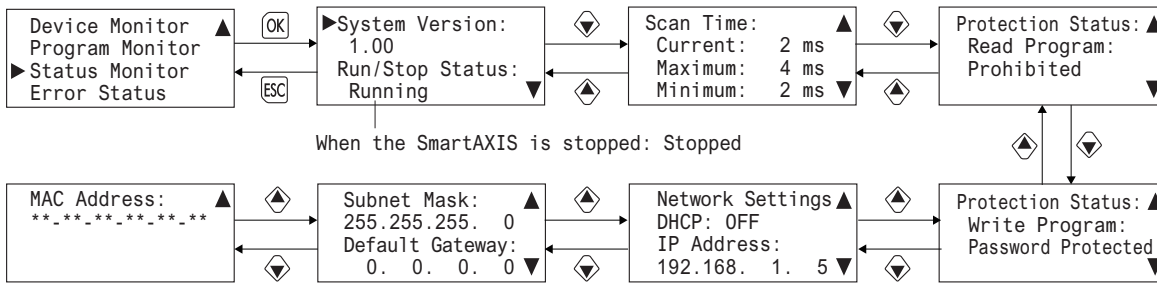

Checking/clearing error information

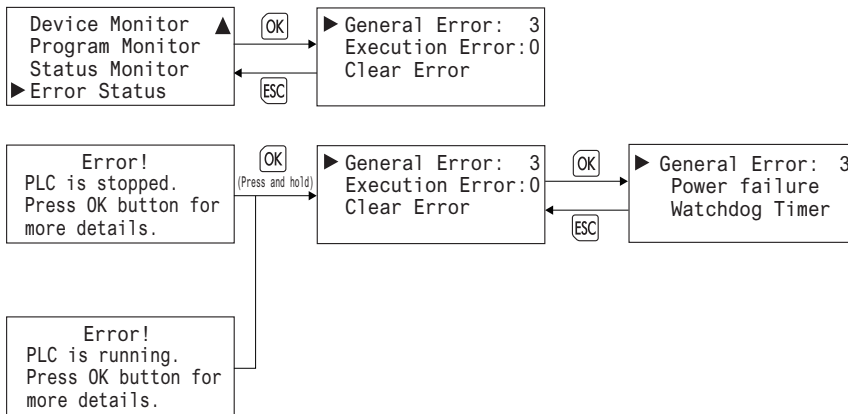

Type List

SmartAXIS Pro / Lite

Type	Power Voltage	I/O Points (Input Points/ Output Points)	Input Type		Output Type			Type No.
			Digital Input	Analog Input (Note)	Relay Output (10A)	Relay Output (2A)	Transistor Output	
Pro	24V DC	12 points (8/4)	6	2	4	—	—	FT1A-H12RA
		24 points (16/8)	12	4		4	—	FT1A-H24RA
		40 points (24/16)	18	6		8	4 (Sink)	FT1A-H40RKA
						4 (Source)	FT1A-H40RSA	
		48 points (30/18)	22	8	—	—	18 (Sink)	FT1A-H48KA
							18 (Source)	FT1A-H48SA
	100-240V AC 50/60Hz	12 points (8/4)	8	—	4	—	—	FT1A-H12RC
		24 points (16/8)	16			4		FT1A-H24RC
40 points (24/16)		24	12			FT1A-H40RC		
48 points (30/18)		30	—		18 (Sink)	FT1A-H48KC		
						18 (Source)	FT1A-H48SC	
Lite	24V DC	12 points (8/4)	6	2	4	—	—	FT1A-B12RA
		24 points (16/8)	12	4		4	—	FT1A-B24RA
		40 points (24/16)	18	6		8	4 (Sink)	FT1A-B40RKA
						4 (Source)	FT1A-B40RSA	
		48 points (30/18)	22	8	—	—	18 (Sink)	FT1A-B48KA
							18 (Source)	FT1A-B48SA
	100-240V AC 50/60Hz	12 points (8/4)	8	—	4	—	—	FT1A-B12RC
		24 points (16/8)	16			4		FT1A-B24RC
40 points (24/16)		24	12			FT1A-B40RC		
48 points (30/18)		30	—		18 (Sink)	FT1A-B48KC		
						18 (Source)	FT1A-B48SC	

Note: Shared with digital inputs

Options

Name	Description/specification		Type No.
SmartAXIS Pro/Lite User's Manual	Japanese	Describes product specifications, installation and wiring instructions, instructions for basic programming operations and special functions, device and instruction lists, communication functions, and troubleshooting procedures for the SmartAXIS Pro/Lite series.	FT9Y-B1377
	English		FT9Y-B1378
	Chinese (simplified)		FT9Y-B1379
	German		FT9Y-B1380
SmartAXIS Ladder Programming Manual	Japanese	Describes basic operations for ladder programming, instructions for monitoring ladders on the SmartAXIS, available devices and instruction lists, and details of each instruction.	FT9Y-B1381
	English		FT9Y-B1382
	Chinese (simplified)		FT9Y-B1383
	German		FT9Y-B1384
SmartAXIS FBD Programming Manual	Japanese	Describes basic operations for function block programming, device and function block lists, and function block actions.	FT9Y-B1385
	English		FT9Y-B1386
Application Software	Automation Organizer		SW1A-W1C
Communication Cartridge	Connection Specifications	Mini DIN	FT1A-PC1
	Standards	EIA RS232C	
	Maximum Baud Rate	115,200bps	
	Communication Functions	Maintenance communication, User communication, Modbus RTU master/slave	
	Isolation between Internal Circuit and Communication Port	Not isolated	
	Connection Specifications	Mini DIN	FT1A-PC2
	Standards	EIA RS485	
	Maximum Baud Rate	115,200bps	
	Communication Functions	Maintenance communication, User communication, Modbus RTU master/slave	
	Isolation between Internal Circuit and Communication Port	Not isolated	
	Connection Specifications	Terminal block	FT1A-PC3
	Standards	EIA RS485	
Maximum Baud Rate	115,200bps		
Communication Functions	Maintenance communication, User communication, Modbus RTU master/slave		
Isolation between Internal Circuit and Communication Port	Not isolated		
End Clips	Used on DIN rail to fasten SmartAXIS modules (package quantity 10)		BNL6PN10
Direct Mounting Hook	Direct mounting hook for 12- and 24-I/O types for maintenance, 5 pcs.		FT9Z-PSP1PN05
SD Memory Card	Capacity: 2GB		HG9Z-XMS2
Memory Cartridge	Dedicated user program save memory		FT1A-PM1
Maintenance Cable	USB maintenance cable USB A male to USB mini-B male, 2m		HG9Z-XCM42
	USB extension cable (for panel attachment) USB mini-B female to USB mini-B male, 1m		HG9Z-XCM21

Fonts

This section describes the fonts that can be displayed on the SmartAXIS Pro LCD.

Supported Languages

The SmartAXIS Pro is equipped with fonts for multiple languages as standard. Messages in the language selected with the MSG instruction can be displayed on the LCD.

The menu can be displayed in English, Chinese, or Japanese, and messages can be displayed in a desired language out of the following languages: German, English, Italian, Spanish, Dutch, French, Cyrillic, Chinese, and Japanese.

Installed Fonts List

Setting name	Character code system	Supported languages
European	ISO8859-1 (Latin-1)	English, German, Italian, Spanish, Dutch (Note), French (Note)
Japanese	Shift-JIS	Japanese (level 1)
Chinese	GB2312	Chinese (simplified)
Cyrillic	ANSI1251	Russian

Note: Some of the characters cannot be input.

Character Code Table

Using the Character Code Table

Example: Finding the character code for the character "a" in the table.

	0	1	2	3	4	5	6	7	8	9	A	B	C	D	E	F	Upper 4 bits of the code (hexadecimal)
0			0	@	P		p					°	À	Đ	à	đ	
1		:	1	^	Q		a	q			i	±	Á	Ñ	á	ñ	
2			"	2	B	R	b	r			ø	²	Ã	Ò	ã	ò	
:			#	3	C	S	c	s			£	³	Ñ	Ó	ã	ó	

Lower 4 bits of the code (hexadecimal)

The upper 4 bits of the code are hexadecimal 6.

The lower 4 bits of the code are hexadecimal 1.

Therefore, the character code for "a" is as follows.

"a": 61

Lower 4 bits

Upper 4 bits

Note: For other fonts and two-byte characters, refer to the table of the relevant code system.

European Font (ISO 8859-1)

	0	1	2	3	4	5	6	7	8	9	A	B	C	D	E	F
0				0	@	P	`	p				°	À	Ð	à	ð
1			!	1	À	Q	a	q			ı	±	Á	Ñ	á	ñ
2			"	2	B	R	b	r			ø	²	Â	Ò	â	ò
3			#	3	C	S	c	s			£	³	Ã	Ó	ã	ó
4			\$	4	D	T	d	t			¤	´	Ä	Ô	ä	ô
5			%	5	E	U	e	u			¥	µ	Å	Õ	å	õ
6			&	6	F	V	f	v			¦	¶	Æ	Ö	æ	ö
7			'	7	G	W	g	w			§	·	Ç	×	ç	÷
8			(8	H	X	h	x			¨	,	È	Ø	è	ø
9)	9	I	Y	i	y			©	¹	É	Ù	é	ù
A			*	:	J	Z	j	z			ª	º	Ê	Ú	ê	ú
B			+	;	K	[k	{			«	»	Ë	Û	ë	û
C			,	<	L	\	l				¬	¼	Ì	Ü	ì	ü
D			-	=	M]	m	}				½	Í	Ý	í	ý
E			.	>	N	^	n	~			®	¾	Î	Þ	î	þ
F			/	?	O	_	o				¯	¿	Ï	Ë	ï	ë

Cyrillic Font (ANSI 1251)

	0	1	2	3	4	5	6	7	8	9	A	B	C	D	E	F
0				0	@	P	`	p	Ђ	ђ		°	А	Р	а	р
1			!	1	А	Q	a	q	ѓ	`	ѳ	±	Б	С	б	с
2			"	2	В	Р	b	r	,	'	ѳ	І	В	Т	в	т
3			#	3	С	Ѕ	c	ѕ	ѓ	"	Ј	і	Г	У	г	у
4			\$	4	Д	Т	d	t	„	“	ѳ	г	Д	Ф	д	ф
5			%	5	Е	У	e	у	…	•	Г	µ	Е	Х	e	x
6			&	6	Ф	В	f	v	†	-	!	¶	Ж	Ц	ж	ц
7			'	7	Г	W	g	w	‡	-	§	·	З	Ч	з	ч
8			(8	Н	Х	h	x	€		Ё	ё	И	Ш	и	ш
9)	9	И	У	i	у	‰	™	©	®	Й	Щ	й	щ
A			*	:	Ј	Ѕ	j	ѕ	љ	љ	Є	е	К	Ѳ	к	ѳ
B			+	;	К	[k	{	<	>	«	»	Л	Ѳ	л	ѳ
C			,	<	Л	\	l		њ	њ	¬	ј	М	Ѳ	м	ѳ
D			-	=	М]	m	}	ќ	ќ	-	ѕ	Н	Э	н	э
E			.	>	Н	^	n	~	ћ	ћ	®	ѕ	О	Ю	о	ю
F			/	?	О	_	o		Ѵ	ѵ	Ї	ї	П	Я	п	я

Japanese Font (JIS X0201)

	0	1	2	3	4	5	6	7	8	9	A	B	C	D	E	F
0				0	@	P	`	p				-	夕	ミ		
1			!	1	A	Q	a	q			。	ア	チ	ム		
2			"	2	B	R	b	r			「	イ	ツ	メ		
3			#	3	C	S	c	s			」	ウ	テ	モ		
4			\$	4	D	T	d	t			、	エ	ト	ヤ		
5			%	5	E	U	e	u			・	オ	ナ	ル		
6			&	6	F	V	f	v			ヲ	カ	ニ	ヨ		
7			'	7	G	W	g	w			ァ	キ	ヌ	ラ		
8			(8	H	X	h	x			イ	ク	ネ	リ		
9)	9	I	Y	i	y			ウ	ケ	ノ	ル		
A			*	:	J	Z	j	z			エ	コ	ハ	レ		
B			+	:	K	[k	{			オ	サ	ヒ	ロ		
C			,	<	L	¥	l				ヤ	シ	フ	ワ		
D			-	=	M]	m	}			ユ	ス	ハ	ン		
E			.	>	N	^	n	~			ヨ	セ	ホ	ッ		
F			/	?	O	_	o				ツ	ソ	マ	°		

INDEX

- #
 - 1:1 Maintenance Communication System 1-7
 - 1:N Maintenance Communication System 1-7
 - 100-ms
 - clock M8122 7-6
 - 10-ms
 - clock M8123 7-6
 - 1-sec
 - clock
 - reset M8001 7-4
 - 2-edge count 5-16
 - 4-edge count 5-16
- A**
 - About the Priority of the Operator 13-35
 - AC Power Type 3-8, 3-11
 - ADD-2comp 10-28
 - Adding counter 5-16
 - address
 - map 11-9, 11-24
 - Adjust
 - function 5-69
 - advanced instruction
 - applicable SmartAXIS 8-6
 - list 8-3
 - all outputs OFF M8002 7-4
 - Allow Access by IP Address 9-7, 11-26
 - Analog
 - Input
 - Allocation 5-39
 - Filter 5-39
 - Arithmetic operation 13-12
 - Arithmetic operator 13-11, 13-23
 - ASCII
 - character code table 10-23
- B**
 - Backlight 14-9
 - basic
 - instructions 8-1
 - Baud Rate (bps) 9-4
 - Bit function 13-12, 13-26
 - Bit operator 13-12
 - Bitwise Operators 13-24
 - BMOV/WSFT executing flag M8024 7-5
 - busy
 - control 10-12
- C**
 - Cable
 - Computer Link
 - 4C A-8
 - O/I Communication A-9
 - 1C A-10
 - 2C A-10
 - cable 10-24, A-6, A-8
 - computer link 4C A-8
 - user communication 1C A-9
 - Calendar & Clock 5-3
 - Calendar and clock
 - data storage locations 5-70
 - calendar data
 - write flag M8016 7-5
 - Calendar/clock
 - error 5-69
 - calendar/clock
 - data
 - read error flag M8014 7-5
 - write flag M8020 7-5
 - write/adjust error flag M8013 7-5
 - carry
 - (Cy) and borrow (Bw) M8003 7-4
 - catch input
 - ON/OFF status M8090-M8095 7-6
 - Character Code Table A-17
 - Checking
 - Error
 - Information 6-20
 - Checking Error Information from the System Menu 6-21
 - Checking the Version A-1
 - Clearing
 - Error
 - Information 6-20
 - clearing
 - error
 - codes 14-2
 - client
 - user communication 10-16
 - client connection
 - connected IP address 5-73
 - Clock
 - Function 5-69
 - clock
 - data
 - adjust flag M8021 5-69, 7-5
 - write flag M8017 7-5
 - Comment 13-15
 - Communication
 - Cartridge 2-23
 - Functions 1-6
 - Ports 1-6, 5-46
 - communication
 - adapter information D8030 7-12
 - error
 - M8005 7-5
 - format 11-12
 - mode information (port 1 through 7) D8026 7-12
 - parameters 10-25, 10-26, 11-5, 11-10
 - settings 11-5
 - Communication Error Information 12-4
 - Communication Ports and Communication Methods 5-46
 - Communication timeout 12-1
 - Comparison
 - Actions 5-17
 - ON status 5-23
 - comparison
 - result
 - 1 M8151 7-7
 - 2 M8150 7-7
 - 3 M8152 7-7

Comparison output reset 5-24
 computer link
 cable 4C A-8
 Conditional branch 13-10
 Configuration file 12-13
 Configuring the Network Settings 6-12
 Configuring the Slave Number 6-11
 confirm
 password 5-65
 connected IP address
 client connection 5-73
 Connection Status 5-73
 Constant 13-15
 Constant Scan Time 5-67
 control
 signal
 option DSR D8105/D8205 10-12
 option DTR D8106/D8206 10-13
 status D8104/D8204 10-11
 Control Statements 13-10, 13-16
 Count direction flag 5-25
 counter
 high-speed 5-13
 keep designation 5-7
 Counter FB 8-12
 CPU module
 type information D8002 7-11
 CRC-16 10-28, 11-11
 Crimping Tool 3-13
 CSV files 5-52
 Current value
 storage locations 5-23
 cyclic redundancy checksum 10-28, 11-11

D

data
 storage setting
 from lower word 5-62
 from upper word 5-62
 Data Bits 9-4
 Data comparison and copy 13-13
 Data Comparison FB 8-12
 Data Conversion FB 8-13
 Data Logging FB 8-14
 data register
 keep designation 5-7
 Data Register ROM Backup 5-9
 Data type conversion 13-13
 Daylight Savings Time 5-68
 DC Power Type 2-5, 3-7, 3-11
 Default gateway 12-8
 default gateway D8092-D8095 7-14
 Derating 2-13
 details button 14-1
 device
 addresses 7-1
 Device Address 13-15
 Device Settings 5-3
 DHCP 5-72
 Dimensions 2-30
 direct
 mounting
 on panel surface 3-4
 disable

 and enable interrupts 5-34, 5-41
 disabling protection 5-65
 Download
 user program 9-1
 download
 program 4-14
 Downloading and uploading user programs 5-49
 Downloading the User Program 6-23
 DSR
 control signal status 10-11
 input control signal option 7-14
 D8105/D8205 10-12
 DTR
 control signal status 10-11
 output control signal option 7-14
 D8106/D8206 10-13
 D-type (type 3) ground 3-7

E

edit user program 4-4
 Entering a Password 6-27
 Environment Settings 6-8
 ERR LED
 during errors 14-4
 Error
 Status LED 2-3, 14-11
 error
 causes and actions 14-4
 code
 user program execution 14-6
 status box 14-1
 ERXD 10-16
 Ethernet 1-9
 Communication 1-9
 Port 2-2, 2-27
 port 5-46
 Status LED 2-2
 use-defined communication 2-27
 ethernet
 user communication 5-75
 ETXD 10-16
 Expansion
 Communication
 Port 2-2
 Wiring Diagram 5-47
 communication
 ports 5-46
 expansion
 communication
 port 2-23
 cover 2-24
 port cover 2-23
 data register
 data status M8026 7-5
 data writing flag M8027 7-5
 external input 5-36

F

falling edge of catch input 5-33
 Ferrules 3-13
 filter
 input 5-38
 Fonts A-17
 forced
 I/O 5-43

- I/O status 5-43
- Format List 13-10
- Format SD memory card with the SmartAXIS 6-26
- Frequency Measurement 5-36
- from
 - lower word 5-62
 - upper word 5-62
- Function 13-12
 - Area Settings 5-2
 - List 5-1, 13-8
 - Specifications 2-6
- function
 - code 11-6, 11-24
- G**
 - general
 - specifications
 - AC power type 2-4
 - DC power type 2-5
- H**
 - Halt and exit 13-11
 - High-speed Counter
 - External Inputs 5-14
 - high-speed counter 5-13
 - comparison output reset M8030, M8040, M8045 7-2
 - gate input M8031, M8035, M8041, M8045 7-6
 - gate input M8031, M8041, M8046 7-2
 - reset input M8032, M8042, M8047 7-2
 - High-speed counter devices 5-22
 - host name 5-75
 - how to use the SmartAXIS buttons 6-3
 - HSC
 - reset input 5-25
- I**
 - I/O
 - forced 5-43
 - status 5-43
 - I/O refresh timing 12-1
 - in-operation output M8125 7-6
 - Input
 - Internal Circuit 2-9, 2-12
 - Operating Range 2-9, 2-12
 - Specifications
 - AC Power Type 2-8
 - DC Power Type 2-10
 - Terminal
 - Wiring 3-7
 - Terminals 2-1
 - input
 - filter 5-38
 - Input Configuration 5-2
 - Input FB 8-9
 - installation
 - and wiring 3-1
 - location 3-1
 - Installed Fonts List A-17
 - instruction
 - ERXD 10-16
 - ETXD 10-16
 - instructions
 - user communication 10-1
 - Interface FB 8-13
 - internal
 - relay
 - keep designation 5-7
- interrupt
 - input 5-34
 - I2 through I5 edge M8080-M8085 7-6
 - status M8070-M8075 7-6
 - IP address 5-75, 12-8
 - IP address D8084-D8087 7-13
 - IP Addresses 9-7
- K**
 - keep
 - data sum check Error 14-4
 - designation 5-7
- L**
 - LCD 2-2
 - Backlight ON Time 6-10
 - Specifications 2-8
 - line
 - control signals RS232C 10-11
 - list
 - advanced instruction 8-3
 - basic instruction 8-1
 - Local Host Port No. 9-7, 11-26
 - Logical Operation FB 8-10
 - Logical operator 13-11, 13-22
 - longitudinal redundancy check 10-28
 - LRC 10-28
- M**
 - MAC address D8078-D8083 7-13
 - maintain outputs while CPU stopped M8025 7-5
 - maintaining catch input 5-33
 - Maintenance
 - Communication 1-7
 - via Ethernet Port 9-5
 - via Expansion Communication Port 9-3
 - via USB Port 9-2
 - maintenance
 - communication 9-1
 - Master communication timeout 12-8
 - Master receive timeout 12-1
 - Memory
 - Cartridge 2-25, 5-49, 6-22, 6-23
 - memory
 - backup error run/stop selection 5-5
 - cartridge
 - cover 2-25, 2-26
 - information D8003 7-11
 - cartridge program transfer error 14-5
 - Memory Backup 5-2
 - Menu Screen 6-2
 - Message Screen 6-2, 6-24
 - Modbus
 - ASCII 10-28
 - communication 11-1
 - Communication 1-8
 - via Ethernet Communication 11-18
 - via via RS-232C/RS-485 11-1
 - master request table 11-4
 - RTU 10-28, 11-11
 - Modbus TCP
 - server specifications 11-24
 - modbus TCP
 - client 5-75, 11-19
 - client specifications 11-19

- communication error 11-19
 - communication format 11-26
 - error status 11-23
 - function code 11-22
 - remote host number 11-23
 - request execution device 11-23
 - server 11-24
 - Modifying a Bit Device Value 6-15
 - Modifying a Word Device Value 6-16
 - monitor
 - operation 4-15
 - Monitor/change
 - device values 9-1
 - Monitoring
 - the SmartAXIS Status 6-19
 - the User Program 6-18
 - monitoring
 - WindLDR 14-1
 - Monitoring Device Values 6-15
 - Mounting
 - Space 3-2
 - mounting
 - hole layout
 - for direct mounting 3-5
 - on panel surface 3-4
- N**
- network settings 5-72
 - Number of I/Os 12-1
 - Number of simultaneously connectable masters 12-8
- O**
- O/I Communication Cable
 - 1C A-10
 - Offset 13-14
 - operating
 - status during errors 14-4
 - Operation
 - Buttons 2-2
 - operation
 - basics 4-1
 - Operator 13-11
 - Operator Interface Connectivity 1-10
 - optional cartridge information D8031 7-12
 - Options 1-2, A-16
 - Output
 - Delay 2-13, 2-14
 - Internal Circuit 2-15
 - Specifications
 - 10A Relay 2-13
 - 2A Relay 2-14
 - Transistor 2-15
 - Terminals 2-2
 - output
 - during errors 14-4
 - Output FB 8-9
 - Overflow 5-24
- P**
- Panel Attachment USB Extension Cable 3-14
 - Parity 9-4
 - password 5-65
 - Password protected 5-64
 - PLC Selection 4-2
 - PLC status 14-1, 14-2
 - port number 5-75
- power
 - failure 14-4
 - supply 3-11
 - wiring 3-12
 - Power Supply
 - Terminals 2-1
 - Power/Run
 - Status LED 2-3, 14-8, 14-10
 - Preset value
 - storage locations 5-17
 - Preset value, reset value
 - storage locations 5-24
 - programming
 - 32-bit data storage setting using WindLDR 5-63
 - catch input 5-32
 - catch input using WindLDR 5-34
 - forced I/O using WindLDR 5-44
 - input filter using WindLDR 5-38
 - interrupt input using WindLDR 5-34
 - Modbus master using WindLDR 11-4
 - Modbus slave using WindLDR 11-10
 - RXD instruction using WindLDR 10-8
 - special data register 10-24
 - timer interrupt using WindLDR 5-41
 - TXD instruction using WindLDR 10-5
 - user communication using WindLDR 10-4
 - user program protection using WindLDR 5-64
 - Programming Scripts 13-10
 - Prohibited 5-64
 - protection
 - user program 5-64
 - Pulse Output FB 8-14
- Q**
- quit WindLDR 4-16
- R**
- read program 5-65
 - reading
 - error data 14-1
 - Reading the data register values from ROM 5-11
 - receive
 - timeout 10-4
 - Receive Timeout (ms) 9-4, 9-7
 - Recommended
 - SD Memory Card 2-28
 - Relational operator 13-11, 13-21
 - remote host list 5-75
 - remote host number
 - modbus TCP 11-23
 - Remote I/O 1-9, 12-1
 - Remote I/O Communication Memory Refresh Image 12-3
 - Remote I/O master 12-1, 12-2, 12-3
 - Remote I/O slave 12-1, 12-3
 - Remote I/O Slave Configuration dialog box 12-1
 - removing
 - from DIN rail 3-3
 - Repeat 13-10
 - request
 - table 11-5
 - reset
 - input 4-18, 5-4, 5-24
 - status 5-25
 - rising edge of catch input 5-33
 - rising/falling edge selection 5-32, 5-34

- RS232C
 - control signal status 7-14
 - DSR input control signal option 7-14
 - DTR output control signal option 7-14
 - line control signals 10-11
 - User Communication 1-8
 - RS232C/RS485 communication 1-6
 - RS485
 - Modbus Communication 1-8
 - RUN mode control signal status 10-11
 - Run/Stop Control 5-2
 - run/stop selection
 - at memory backup error 5-5
 - at power up 5-6
 - rung 4-3, 4-4
 - Running 6-7
- S**
- save destination for log data 5-55
 - Save Log Data 5-52
 - Script Editor 13-6
 - Script FB 8-15
 - Script Manager 13-5
 - Script Programming Examples 13-16
 - Scroll Speed 6-13
 - Scroll Unit 6-14
 - SD Memory Card 2-28, 5-52
 - Access Stop Flag 7-6
 - Capacity 7-13
 - Slot 2-2
 - Special Internal Relays 5-56
 - Status LED 2-2, 5-56
 - SD Memory Card Maintenance 5-53
 - Self Diagnostic 5-3
 - sensor
 - power
 - terminals 2-3
 - server
 - connection (1 through 8) connected IP address D8110-D8121 7-14
 - user communication 10-19
 - Setting
 - Calender/Clock 6-9
 - Clock 5-69, 5-70, 6-9
 - shift
 - register
 - keep designation 5-7
 - Shift Register FB 8-12
 - simulate operation 4-12
 - Single-phase high-speed counter 5-14, 5-15
 - Slave Number 9-4
 - special
 - functions 5-1
 - Special data register
 - list 5-23, 7-8
 - special data register 7-8, 12-3
 - for error information 14-3
 - for interrupt inputs 5-34
 - for RS232C line control signals 10-11
 - for scan time 5-67
 - for timer interrupt 5-41
 - list 7-8
 - Special FB 8-15
 - Special internal relay
 - list 5-23
 - special internal relay 7-2, 12-3
 - for catch inputs 5-32
 - for interrupt inputs 5-34
 - for timer interrupt 5-41
 - specifications
 - catch input 5-32
 - Modbus master communication 11-2
 - user communication mode 10-1
 - Standard Screen 6-2
 - start
 - control M8000 7-4
 - WindLDR 4-1, 4-3
 - Start/stop
 - high-speed counter 5-23
 - start/stop
 - operation 4-17
 - schematic 4-17
 - using power supply 4-18
 - using WindLDR 4-17
 - Starting the Data File Manager 5-53
 - status
 - system 4-18
 - stop
 - input 4-18, 5-4
 - Stop Bits 9-4
 - STOP mode control signal status 10-11
 - Stopping 6-7
 - Stopping Access to the SD Memory Card 6-25
 - Subnet mask 12-8
 - subnet mask D8088-D8091 7-13
 - Supported Languages 1-3, A-17
 - Switching to the System Menu 6-6
 - System
 - Menu
 - Hierarchy Diagram 6-28
 - system
 - program
 - version D8029 7-12, 14-1
 - setup
 - ID quantity of inputs D8000 7-11
 - ID quantity of outputs D8001 7-11
 - RS232C user communication 10-2
 - RS485 user communication 10-3
 - software
 - upgrade A-1
 - statuses at stop, reset, and restart 4-18
- T**
- table ASCII character code 10-23
 - Temporary Device 13-15
 - Terminal
 - Arrangement 2-16
 - terminal
 - connection 3-13
 - Terminals for Terminal Blocks 3-13
 - timer
 - interrupt
 - status M8144 7-7
 - Timer FB 8-11
 - timer/counter
 - preset value
 - sum check error 14-4
 - troubleshooting 14-1

- diagrams 14-7
 - Two-phase high-speed counter 5-14, 5-15
 - Type
 - List 1-2, A-15
- U**
- Underflow 5-24
 - Up/down selection reversible counter 5-16
 - upgrade SmartAXIS system software A-1
 - Upload
 - user programs 9-7
 - Uploading the User Program 6-22
 - USB 4-14
 - Port 2-2
 - port 5-46
 - USB Port
 - Cover 2-2
 - User
 - Communication 1-8
 - Program
 - Protection 5-64
 - Program Passwords 5-51
 - user
 - communication
 - cable 1C A-9
 - error code 10-22
 - instructions 10-1
 - receive instruction cancel flag
 - M8100-M8102 7-6
 - port 2 M8022 7-5
 - port 3 M8023 7-5
 - system
 - setup RS232C 10-2
 - setup RS485 10-3
 - program
 - execution error 14-6
 - M8004 7-5
 - keep data sum check error 14-4
 - protection 5-64
 - ROM sum check error 14-4
 - syntax error 14-4
 - writing error 14-4
 - protocol 10-4
 - User Communication
 - via Ethernet Communication 10-14
 - via Serial Communication 10-1
 - user communication
 - cancel flag 10-16, 10-19
 - server 10-19
- master 11-4
 - slave 11-10
 - RXD instruction 10-8
 - timer interrupt 5-41
 - TXD instruction 10-5
 - user
 - communication 10-4
 - program protection 5-64
 - quit 4-16
 - start 4-1, 4-3
 - wiring 3-7
 - power supply 3-12
 - Word function 13-12, 13-26
 - write program 5-65
 - Writing the data register values to ROM 5-10
 - Writing/Clearing CP(Counter Preset Values) 6-17
 - Writing/Clearing TP(Timer Preset Values) 6-17

IDEC CORPORATION

 www.idec.com

Head Office

6-64, Nishi-Miyahara-2-Chome, Yodogawa-ku, Osaka 532-0004, Japan

USA	IDEC Corporation	Tel: +1-408-747-0550	opencontact@idec.com	Hong Kong	IDEC Izumi (H.K.) Co., Ltd.	Tel: +852-2803-8989	info@hk.idec.com
Germany	APEM GmbH	Tel: +49-40-25 30 54 - 0	service@eu.idec.com	China/Shanghai	IDEC (Shanghai) Corporation	Tel: +86-21-6135-1515	idec@cn.idec.com
Singapore	IDEC Izumi Asia Pte. Ltd.	Tel: +65-6746-1155	info@sg.idec.com	China/Shenzhen	IDEC (Shenzhen) Corporation	Tel: +86-755-8356-2977	idec@cn.idec.com
Thailand	IDEC Asia (Thailand) Co., Ltd.	Tel: +66-2-392-9765	sales@th.idec.com	China/Beijing	IDEC (Beijing) Corporation	Tel: +86-10-6581-6131	idec@cn.idec.com
Australia	IDEC Australia Pty. Ltd.	Tel: +61-3-8523-5900	sales@au.idec.com	Japan	IDEC Corporation	Tel: +81-6-6398-2527	marketing@idec.co.jp
Taiwan	IDEC Taiwan Corporation	Tel: +886-2-2698-3929	service@tw.idec.com				

Specification and other descriptions in this brochure are subject to change without notice.

Information in this brochure is current as of May, 2019.

2019 IDEC Corporation, All Rights Reserved.

FT9Y-B1378(5)

