

INSTRUCTION SHEET
EB3L-N Lamp Barrier
(Lamp and Buzzer Signal Transducer)

To make sure of correct installation, wiring, operation, maintenance, and inspection of the EB3L-N lamp barrier, read this instruction manual, manual No. **B-1341-1~8** for intrinsically safe system, and for use in Japan, additional manual No. **B-755, B-756, B-757** for Pilot Light, Buzzer, Illuminated Switches.

Make sure that this manual be kept at the last user of the EB3L-N lamp barrier.

[Specifications]

Certification Body	Applicable Standard	Performance for Type of Protection	Manual
TIIS	International explosion protecting guideline	[Ex ia] IIC	No.B-1341-1
IECEX(PTB)	IEC 60079-11	[Ex ia] IIC / [Ex ia] IIIC	No.B-1341-2
ATEX(PTB)	EN 60079-11	II(1)G[Ex ia] IIC / II(1)D[Ex ia] IIIC	No.B-1341-3
FM	3610	[I/O] AEx[ia]/IIC ※1	No.B-1341-4
CQST	GB3836.1 GB3836.4	[Ex ia Ga] IIC	No.B-1341-5
NK	Ship's classification	[Ex ia] IIC	※2
KCS	IEC 60079-11	[Ex ia] IIC/[Ex iaD]	No.B-1341-6
UL	UL913 UL60079-0 UL60079-11 UL61010-1	CL I Gr A,B,C,D; CL II Gr E,F,G; CL III [AEx ia] II C	No.B-1341-7
CNS	IEC 60079-11	[Ex ia] IIC/[Ex ia] IIIC	No.B-1341-8
KR	IEC 60079-11	[Ex ia] IIC/[Ex ia] IIIC	※3

※1 : and AIS Cl. I, II, III, Div. 1, Gr. A,B,C,D,E,F,G
 ※2 : see No.B1341-1, therefor Certificate Body not specified Manual.
 ※3 : see No.B1341-2, therefor Certificate Body not specified Manual.

Standard for equipment	IEC60079-11, IEC60947-5-1
Degree of Protection	IP20
Operating Temperature	-20 to +60°C (no freezing)
Operating Humidity	45 to 85% RH (no condensation)
Atmosphere	800 to 1100 hPa
Pollution Degree	2
Rated Power Voltage	100 to 240V AC, +10 or -15% , 24V DC ±10%
Power Consumption	AC(approx.) 10.2 VA (EB3L-S10SAN at 200V AC) DC(approx.) 5.2 W (EB3L-S16CSDN at 24V DC)
Inrush Current	AC: 10A (100V AC), 20A (200V AC) DC: 10A (24V DC)
Operation	Input ON: Output ON (1:1) ※4
Signal Input	24VDC, 5mA <Connector Type: 24VDC, 4mA> Class2 DC power supply voltage: Rated voltage -1.2V
Signal Output	12V DC, 10mA ※5 (n = number of lines per common) Wiring allowable resistance: Lw = 200Ω/(1+n) maximum
Dielectric Strength	Between intrinsically safe circuit and non-intrinsically safe circuit: 1526.4V AC※6 Between AC power and input terminal: 1500V AC※6 Except for between DC power and input terminal
Terminal Style	M3 screw terminal
Connector(Barrier)	JE1H-202 (IDEC Corp.) <ACCESSORY(mating connector): JE1S-201>※7
Wire Size (per one terminal)	One wire : 0.5 to 2.0 mm ² (AWG20 to 14) Two wires : 0.5 to 1.5 mm ² (AWG24 to 16) (same size)
Mounting	35mm-wide DIN rail or panel mounting (M4 screw)
Weight (approx.)	0.35 kg (EB3L-S16CSDN)

※4: When the protection circuit for the intrinsically safe explosion protection is actuated, all LEDs and all outputs turn off.

※5: (EB3P-L*): typ. 3.5V 8.5mA, (IPL1-*): typ. 2.0V 10mA, (EB3P-Z*): typ. 6.5V 5.5mA

※6: Leak current less than 5mA

※7: Connector type only. If used as UL Listed product, please use "HIF3BA-20D-2.54R(HIROSE Electric)" for the mating connector.

Additional Items for UL Listing

Overvoltage category	II
Rated Voltage	100 to 120V AC, +10 or -15% 50/60Hz 24V DC±10%(Class2 power supply)
Power Consumption	AC: (MAX)10.3 VA (EB3L-S10SAN at 120V AC) DC: (MAX)6.5W(EB3L-S16CSDN at 26.4V DC)
Mating Connector	HIF3BA-20D-2.54R(HIROSE Electric) ※7
Wire Size (per one terminal)	One wire : AWG16 to 14 (1.25 to 2.0 mm ²) voltage rating minimum 125V, temperature minimum 70 deg.C

< Safety Precautions >

Use the EB3L-N lamp barrier only for the protection of electrical equipment used in potentially explosive atmospheres. In this instruction manual, safety precautions are categorized in order of importance to Warning and Caution.

! WARNING *Improper operation may cause severe personal injury or death.*

- Special expertise is required to install, wire, operate, maintain, and inspect the EB3L-N lamp barrier. People without such expertise and knowledge in the installation of electrical equipment used in potentially explosive atmospheres and electric systems, relevant regulations, principle, function, and skill must not use the EB3L-N lamp barrier.
- Install the EB3L lamp barrier in non-hazardous areas.
- Make sure that the operating environment is in accordance with the specifications.

! CAUTION *Inattention might cause personal injury or damage to equipment.*

- Use the EB3L-N lamp barrier within the rated values of the specifications.
- Do not use the damaged EB3L-N lamp barrier, otherwise injury or fire may result.
- Indoor use
- When disposing of the EB3L-N lamp barrier, do so as an industrial waste

[Installation]

< Mounting Hole Layout (Screw mounting) > (All Dimensions in mm)

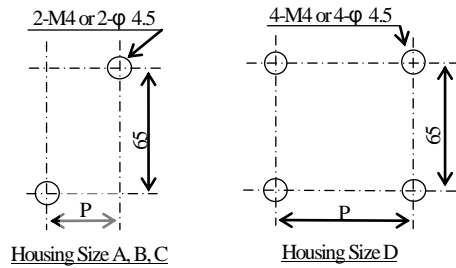

< Mounting Hole Dimensions >

Housing Size	Number of Circuits	P (mm)	L (mm)
A	1	28.0	42.0
B	2,3	51.0	65.0
C	5,6, 8 common	97.0	110.5
D	8,10, 16 common connector 16	97.0	171.5

•Screw Terminal Type

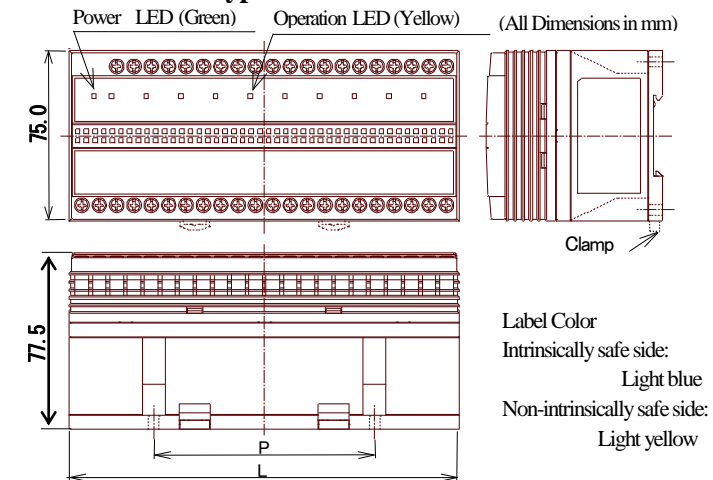

•Connector Type

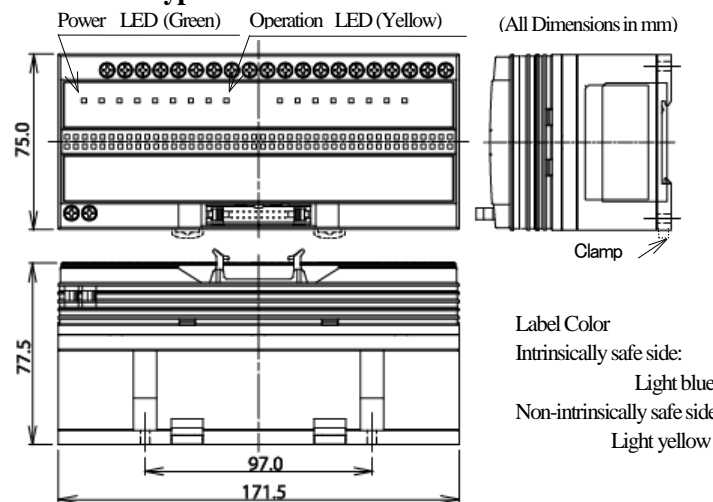

[Instructions]

1) Mounting

- The EB3L-N lamp barrier can be installed in any direction.
- Install the EB3L-N lamp barrier securely to withstand vibrations.
- When mounting the EB3L-N lamp barrier onto a DIN rail, make sure to press in the clamp completely. Use the BNI6 mounting clips to prevent the EB3L-N lamp barrier from moving sideways.

2) Terminal Wiring

- Provide IP20 for wiring of the EB3L-N lamp barrier. Use shielded wires for bare crimping terminals.
- Using a φ5.5 mm or smaller screw driver, tighten the screw to a torque of 0.6 to 1.0N·m.

3) Power

- Do not apply an expressive power, otherwise the EB3L-N lamp barrier may be damaged.
- AC power type may operate at a low voltage (20V AC).

4) Signal Input

- Connect to switches or output devices with a small leakage current (0.1 mA maximum).
- Do not apply a voltage to input terminals because a power supply is contained.

6) Wiring

- Separate the EB3L-N lamp barrier wiring from motor lines which cause noises. When the LED lamp blinks due to noises caused by an inductive load, insert a line filter into the power line. The line filter must be for the rated current of the lamp barrier or larger.
- When the protection circuit has been actuated, remove the cause and power up again.

< Stripping the Wire End >

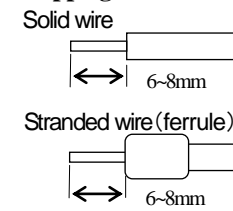

< Applicable Crimping Terminal >

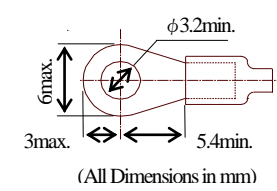

[Internal Circuit Block Diagram]

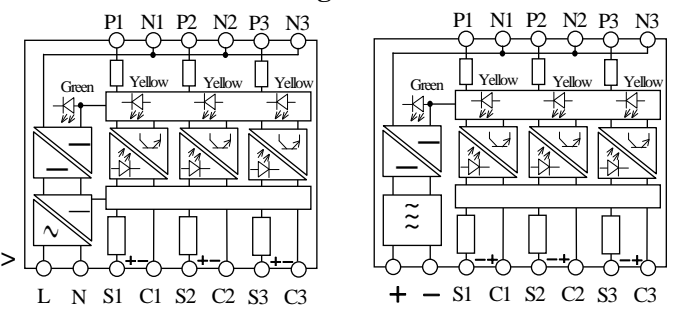

< Ex.1 AC power source input >

< Ex.2 DC power sink input >

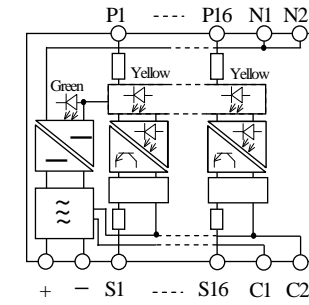

< Ex.3 Connector Type Source input >

[Input Circuit]

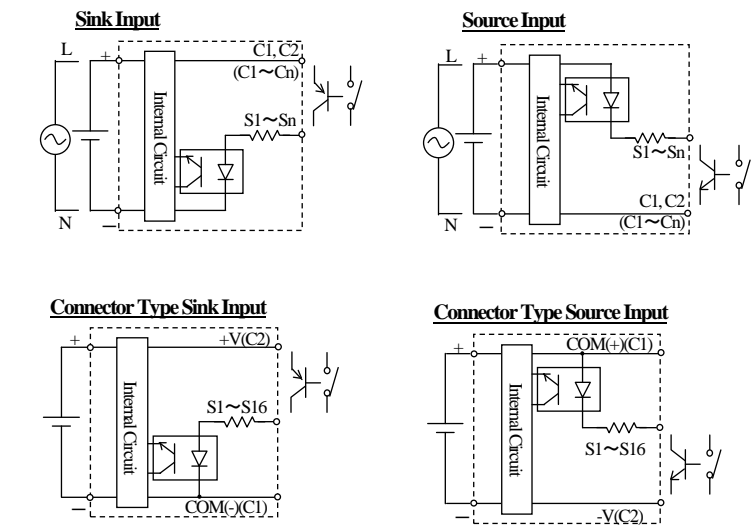

[Wiring of Connector Type]

< Connection with PLC (FC4A series)>

EB3L-S16CSD-CN		FC4A-T16K3		EB3L-S16CKD-CN		FC4A-T16S3	
Terminal	Input	Output	Terminal	Terminal	Input	Output	Terminal
20	S1	Y0	20	19	S1	Y0	20
19	S9	Y10	19	18	S9	Y10	19
18	S2	Y1	18	18	S2	Y1	18
17	S10	Y11	17	17	S10	Y11	17
16	S3	Y2	16	16	S3	Y2	16
15	S11	Y12	15	15	S11	Y12	15
14	S4	Y3	14	14	S4	Y3	14
13	S12	Y13	13	13	S12	Y13	13
12	S5	Y4	12	12	S5	Y4	12
11	S13	Y14	11	11	S13	Y14	11
10	S6	Y5	10	10	S6	Y5	10
9	S14	Y15	9	9	S14	Y15	9
8	S7	Y6	8	8	S7	Y6	8
7	S15	Y16	7	7	S15	Y16	7
6	S8	Y7	6	6	S8	Y7	6
5	S16	Y17	5	5	S16	Y17	5
4	C1 (COM-)	COM(-)	4	4	C1 (COM+)	COM(+)	4
3	NC	COM(-)	3	3	NC	COM(+)	3
2	C2 (+V)	+V	2	2	C2 (-V)	-V	2
1	NC	+V	1	1	NC	-V	1

(Note) A dotted line is not related to operation.

Applicable Connector : JE1S-201(IDEC CORPORATION)

Note:

• When connecting multiple barrier in parallel, use one power supply to power the barrier.

• Terminals C1 and C2 are external power supply terminals which can supply a maximum current of 50 mA to an external device such as a PLC.