

# PS5R-S

## Switching Power Supplies



# The Slimmest Switching Power Supplies in Its



**Before**

A cluster of switching power supplies occupied a large space in a panel, making it difficult to install other products.

**Width: 22.5mm (10/15W), 36mm (30/60W), 46mm (90W), 50mm (120W), 80mm (240W)**

Large capacity slim style.

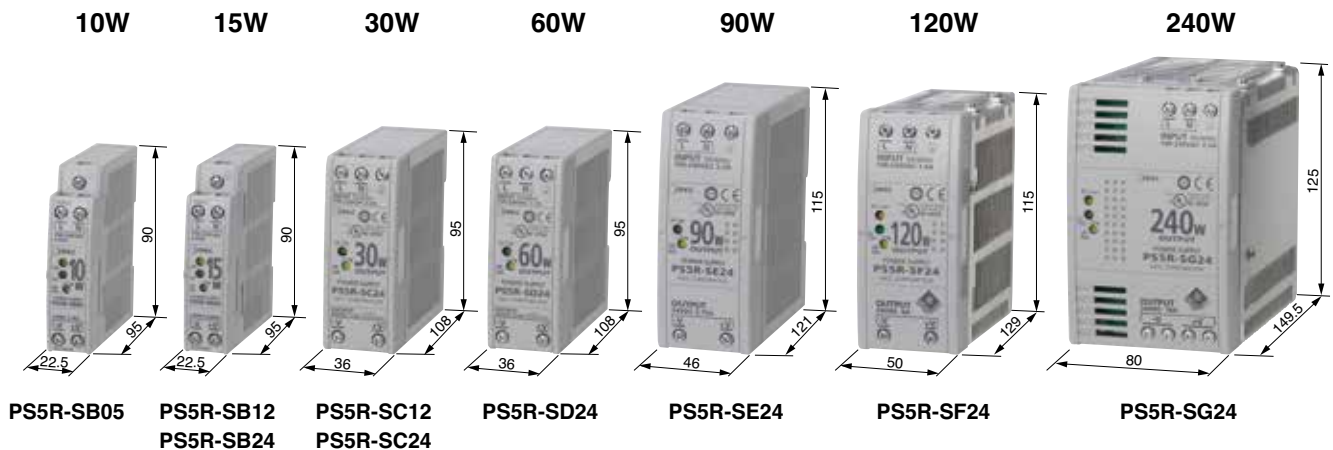

All dimensions in mm.

# Class Create More Space in Your Panel.

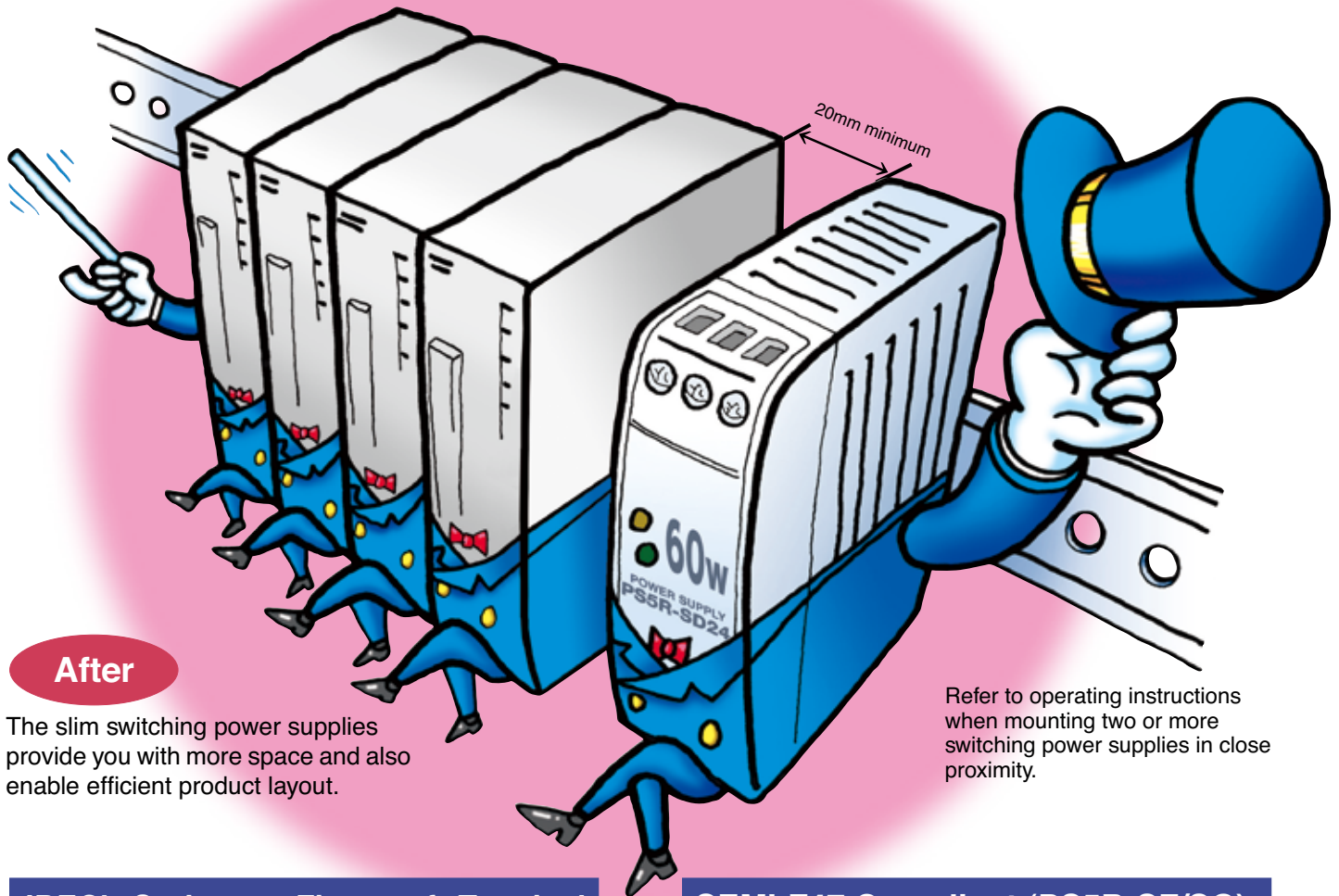

**After**

The slim switching power supplies provide you with more space and also enable efficient product layout.

Refer to operating instructions when mounting two or more switching power supplies in close proximity.

## IDEC's Spring-up, Fingersafe Terminal

Spring-up, fingersafe terminals reduce wiring time and provide enhanced safety.

### Less wiring time

- Spring-up screws are captive, therefore screws will not be lost.
- Ring terminals can be connected.

### Finger-safe

- Terminals cannot be touched, preventing electric shocks.



## Separate Input and Output Terminals

Upper terminals: Input  
Lower terminals: Output

## Universal AC Voltage (100 to 240V AC)

## 3-Year Warranty

## SEMI-F47 Compliant (PS5R-SF/SG)

The PS5R-S switching power supplies are certified by EPRI PEAC, and "PQ Star" is marked on the product. SEMI-F47 "Specification for Semiconductor Processing Equipment Voltage Sag Immunity" defines voltage sag ride-through capability design requirements for semiconductor processing, metrology, and automated test equipment.



## Safety and High Quality

Compliant with UL1604, the PS5R-S switching power supplies can be used in hazardous locations—Class 1 Division 2, Groups A, B, C, and D.

UL508, UL1310 Class 2 (PS5R-SB/SC/SD), UL1604, CSA No. 14, No. 213, No. 223, EN 60950-1, EN50178, EN61204-3 (Class B) compliant.



## Panel Mounting Possible

The PS5R-S switching power supplies can be installed on a panel using a mounting bracket.



Installation Example



# PS5R-S Switching Power Supplies

**Slim size DIN rail mount switching power supplies with finger-safe terminals**  
**Universal input; Wide power range 10W, 15W, 30W, 60W, 90W, 120W, and 240W**

- Compact and light-weight  
Width: 22.5 mm (10W/15W), 36 mm (30W/60W), 46 mm (90W), 50 mm (120W), 80 mm (240W)
- Universal AC input (DC compatible)
- DIN rail mounting. Optional mounting bracket is available for panel surface mount.
- IP20 fingersafe spring-up screw terminals
- CE marked (LVD and EMC)
- EN61204-3 (DC power supply EMC Directive Class B) approval, VCCI Class B compliant



## PS5R-S

Output Capacity	Part No.	Input Voltage	Output Voltage	Output Current
10W	PS5R-SB05	100 to 240V AC (Voltage range: 85 to 264V AC, 100 to 370V DC)	5V	2.0A
15W	PS5R-SB12		12V	1.2A
	PS5R-SB24		24V	0.65A
30W	PS5R-SC12		12V	2.5A
	PS5R-SC24		24V	1.3A
60W	PS5R-SD24		24V	2.5A
90W	PS5R-SE24		24V	3.75A
120W	PS5R-SF24		100 to 240V AC (Voltage range: 85 to 264V AC, 100 to 350V DC)	24V
240W	PS5R-SG24	24V	10.0A	

Applicable Standards	Mark	File No. or Organization
UL508 ANSI/ISA-12.12.01-2007 UL1310 Class 2 (PS5R-SB/SC/SD) CSA C22.2 No. 14/213 CSA C22.2 No. 223 (PS5R-SB/SC/SD)		UL/c-UL File No. E234997
EN60950-1 EN50178 EN61204-3		TÜV SÜD
		EU Low Voltage and EMC Directives
SEMI F47 (PS5R-SF/SG)		EPRI PEAC

## DIN Rail

Shape	Specifications	Part No.	Ordering No.	Package Quantity	Remarks
	Aluminum Weight: Approx. 200g	BAA1000	BAA1000PN10	10	Length: 1m Width: 35 mm
	Steel Weight: Approx. 320g	BAP1000	BAP1000PN10	10	

## End Clip

Shape	Specifications	Part No.	Ordering No.	Package Quantity	Remarks
	Zinc-plated steel Weight: Approx. 15g	BNL5	BNL5PN10	10	Used on a DIN rail to fasten switching power supplies.
		BNL6	BNL6PN10	10	

## Panel Mounting Bracket

Applicable Switching Power Supply	Ordering No.	Package Quantity	Remarks
PS5R-SB	PS9Z-5R1B	1	For upright mounting
	PS9Z-5R2B	1	For flat mounting
PS5R-SC PS5R-SD	PS9Z-5R1C	1	For upright mounting
PS5R-SE	PS9Z-5R1E	1	For upright mounting
PS5R-SF PS5R-SG	PS9Z-5R1G	1	For upright mounting

## Part No. Development

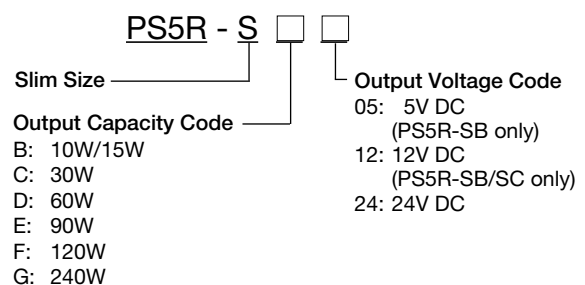

# PS5R-S Switching Power Supplies

## Specifications

Part No.		PS5R-SB05 PS5R-SB12 PS5R-SB24 (10W/15W)	PS5R-SC12 PS5R-SC24 (30W)	PS5R-SD24 (60W)	PS5R-SE24 (90W)	PS5R-SF24 (120W)	PS5R-SG24 (240W)	
Input	Rated Input Voltage (Single-phase two-wire) (Note 1)	100 to 240V AC (Voltage range: 85 to 264V AC/100 to 370V DC) (Load ≤ 80% at 100-105V DC)				100 to 240V AC (Voltage range: 85 to 264V AC/100 to 350V DC) (Load ≤ 80% at 100-110V DC)		
	Frequency	50/60 Hz						
	Input Current	100V AC	0.45A max.	0.9A max.	1.7A max.	2.3A max.	1.8A max.	3.5A max.
		200V AC	0.3A max.	0.6A max.	1.0A max.	1.4A max.	1.0A max.	1.7A max.
	Inrush Current	50A max. (Ta = 25°C, 200V AC cold start)						
	Leakage Current	132V AC	0.38 mA max.				0.5 mA max.	
		264V AC	0.75 mA max.				1.0 mA max.	
	Efficiency (Typical)	5V DC	69%	—	—	—	—	—
		12V DC	75%	78%	—	—	—	—
		24V DC	79%	80%	83%	82%	84%	84%
Power Factor (Typical)	100V AC	—	—	—	—	0.99	0.99	
	230V AC	—	—	—	—	0.90	0.92	
Output	Rated Voltage/Current	5V/2.0A (Note 2) 12V/1.2A 24V/0.65A	12V/2.5A 24V/1.3A	24V/2.5A	24V/3.75A	24V/5A	24V/10A	
	Adjustable Voltage Range	±10%						
	Output Holding Time	20 ms min. (at rated input and output)						
	Start Time (at rated input and output)	200 ms max.				650 ms max.	500 ms max.	
	Rise Time (at the rated input and output)	100 ms max.				200 ms max.		
	Regulation	Input Fluctuation	0.4% max.					0.8% max.
		Load Fluctuation	1.5% max.					
		Temperature Change	0.05%/°C max. (-10 to +60°C)	0.05%/°C max. (-10 to +55°C)	0.05%/°C max. (-10 to +40°C)			
		Ripple (including noise)	2% p-p max. (-10 to +60°C)	2% p-p max. (-10 to +55°C)	2% p-p max. (-10 to +40°C)		1% p-p max. (-10 to +40°C)	
	Supplementary Functions	Overcurrent Protection	105% min. (auto reset)			103 to 110% (auto reset)	105 to 130% (auto reset)	
Overvoltage Protection		Output off at 120% min. (Note 3)						
Operation Indicator		LED (green)						
Voltage Low Indication		LED (amber)	No			LED (amber)		
Dielectric Strength		Between input and output terminals: 3,000V AC, 1 minute (at 25°C, 70% RH) Between input and ground terminals: 2,000V AC, 1 minute (at 25°C, 70% RH) Between output and ground terminals: 500V AC, 1 minute (at 25°C, 70% RH)						
Insulation Resistance		Between input and output terminals: 100MΩ min. (500V DC megger) (at 25°C, 70% RH) Between input and ground terminals: 100MΩ min. (500V DC megger) (at 25°C, 70% RH)						
Operating Temperature		-10 to +65°C (no freezing) (Note 4)	-10 to +60°C (no freezing)					
Storage Temperature		-25 to +75°C (no freezing)						
Operating Humidity		20 to 90% RH (no condensation)						
Vibration Resistance		10 to 55 Hz, amplitude 0.375 m, 2 hours each in 3 axes						
Shock Resistance		300 m/s <sup>2</sup> (30G) (150 m/s <sup>2</sup> when using panel mounting bracket, except for PS5R-SB with 300 m/s <sup>2</sup> ), 3 shocks each in 6 axes						
EMC	EMI	EN61204-3 (Class B)						
	EMS	EN61204-3 (industrial)						
Applicable Standards		UL508 (Listing), ANSI/ISA-12.12.01-2007, UL1310 Class 2 CSA C22.2 No. 14 CSA C22.2 No. 213 CSA C22.2 No. 223 EN50178, EN60950-1			UL508 (Listing), ANSI/ISA-12.12.01-2007 CSA C22.2 No. 14 CSA C22.2 No. 213, EN50178, EN60950-1			
Other Standard		—				SEMI F47		
Dimensions (mm)		90H × 22.5W × 90D	95H × 36W × 108D		115H × 46W × 121D	115H × 50W × 129D	125H × 80W × 149.5D	
Weight (approx.)		160g	250g	286g	440g	630g	1000g	
Terminal Screw		M3.5 slotted-Phillips head screw						

Note 1: DC input voltage is not subjected to safety standards. The input voltage range approved by safety standards is 100 to 240V AC. When using on DC input, connect a fuse to the input terminal for DC input protection.

Note 2: PS5R-SB05 (5V DC/2.0A) is 10W.

Note 3: One minute after the output has been turned off, turn on the input again.

Note 4: See the output derating curves.

## Reference Value

Expected Life	8 years minimum (at the rated input, 50% load, operating temperature +40°C, standard mounting direction)
---------------	--

Calculation of the expected life is based on the actual life of the aluminum electrolytic capacitor. The expected life is subjected to operating conditions.

# PS5R-S Switching Power Supplies

## Block Diagrams

### PS5R-SB/SC

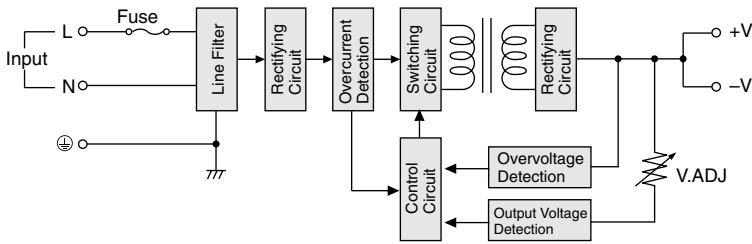

### PS5R-SD/SE

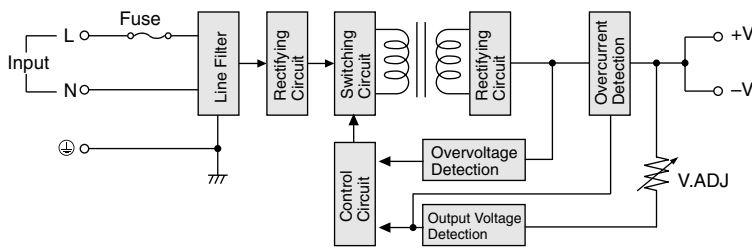

### PS5R-SF/SG

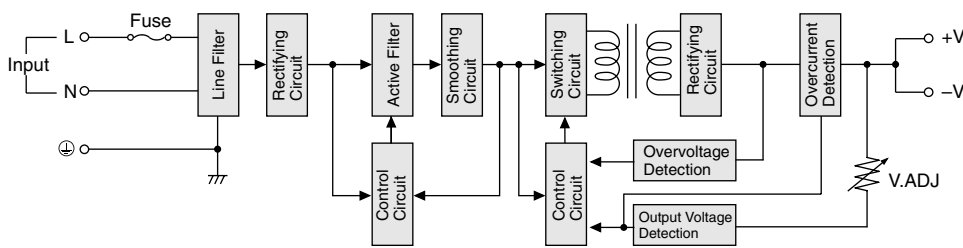

## Characteristics

### Operating Temperature vs. Output Current (Derating Curves)

Conditions: Natural air cooling

PS5R-SB

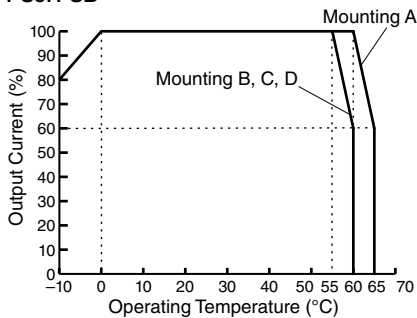

PS5R-SC

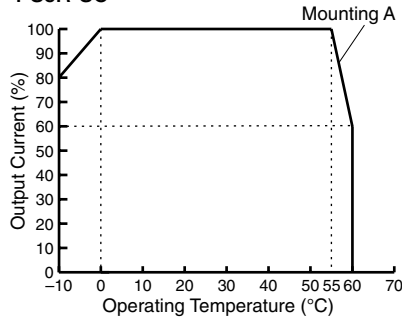

PS5R-SD/SE/SF

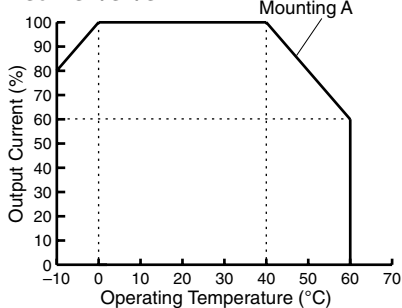

PS5R-SG

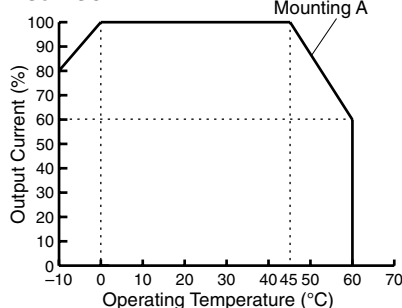

# PS5R-S Switching Power Supplies

Operating Temperature Approved by Safety Standards UL 508, EN 60950-1, and EN 50178

Part No.	UL 508		EN 60950-1, EN 50178	
	Mounting A	Mounting B, C, and D	Mounting A	Mounting B, C, and D
PS5R-SB05, -SB12, -SB24	55	55	60	55
PS5R-SC12, -SC24	55	Impossible	55	Impossible
PS5R-SD24, -SE24, -SF24	40	Impossible	40	Impossible
PS5R-SG24	45	Impossible	45	Impossible

## Mounting Style

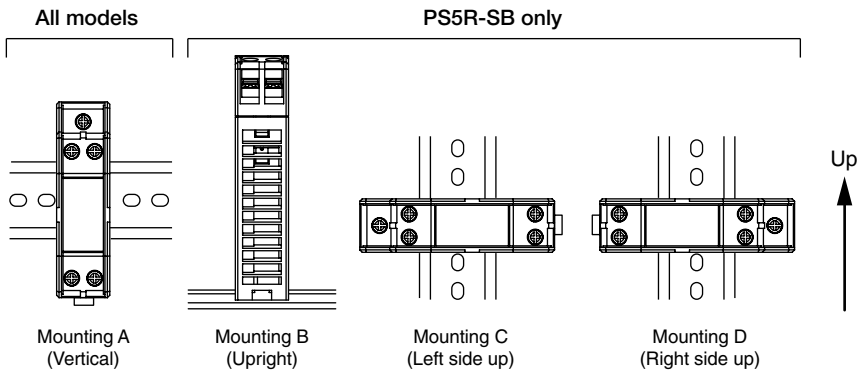

## Overcurrent Protection Characteristics

PS5R-SB

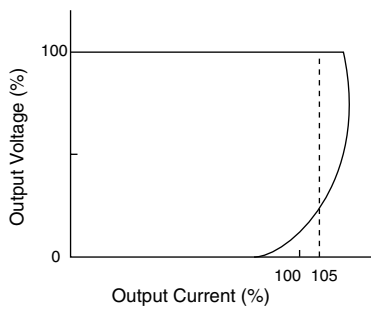

PS5R-SC

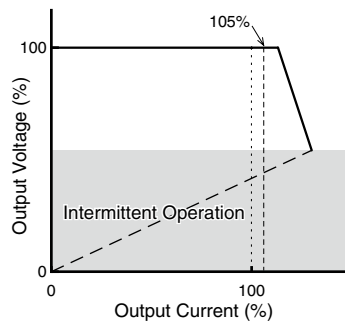

PS5R-SD

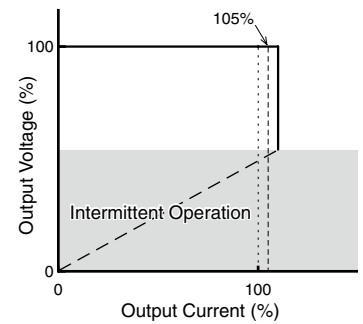

PS5R-SE

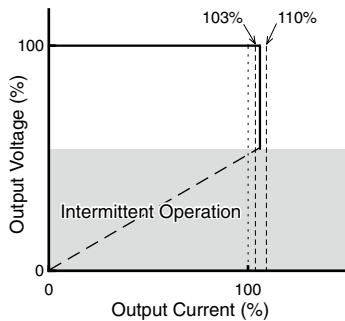

PS5R-SF/SG

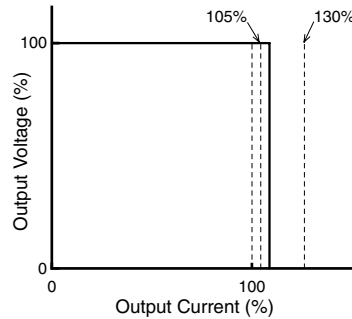

# PS5R-S Switching Power Supplies

## Dimensions

PS5R-SB

General tolerance: ±1 mm

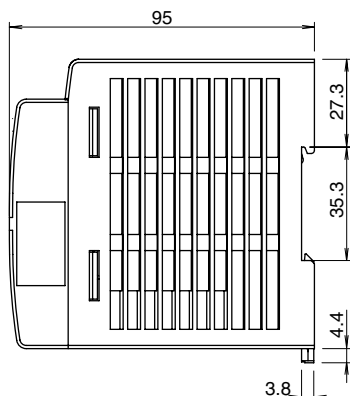
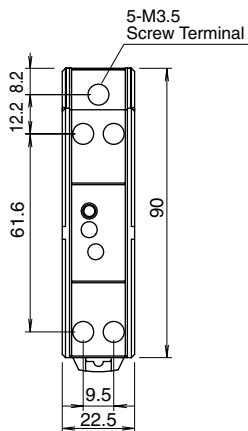

PS9Z-5R1B  
Panel Mounting Bracket

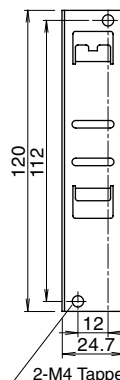

PS9Z-5R2B  
Panel Mounting Bracket

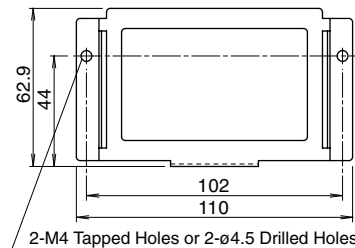

PS5R-SC/SD

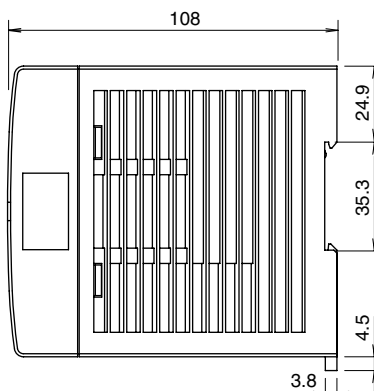
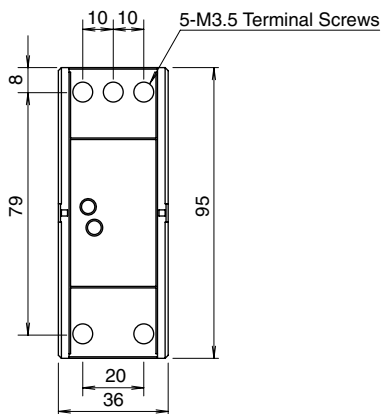

PS9Z-5R1C  
Panel Mounting Bracket

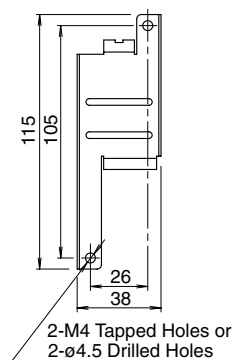

PS5R-SE

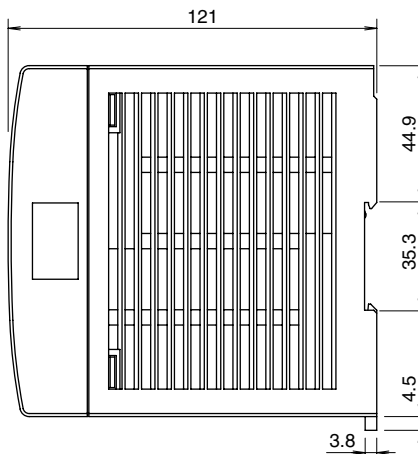
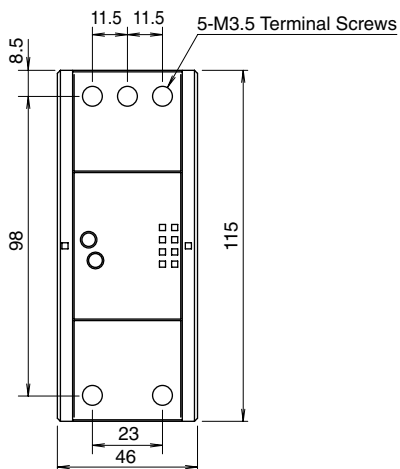

PS9Z-5R1E  
Panel Mounting Bracket

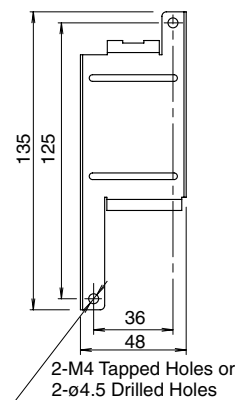

All dimensions in mm.



# PS5R-S Switching Power Supplies

PS5R-SF

General tolerance:  $\pm 1$  mm

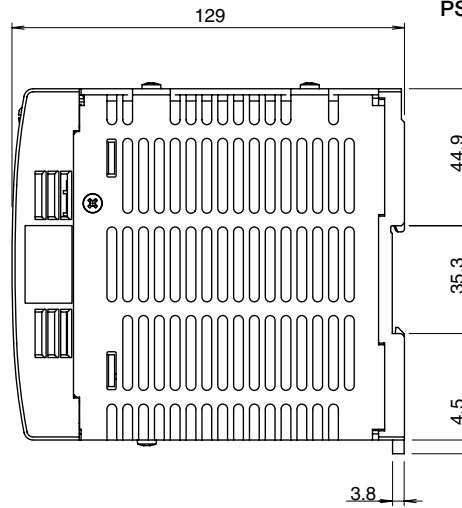
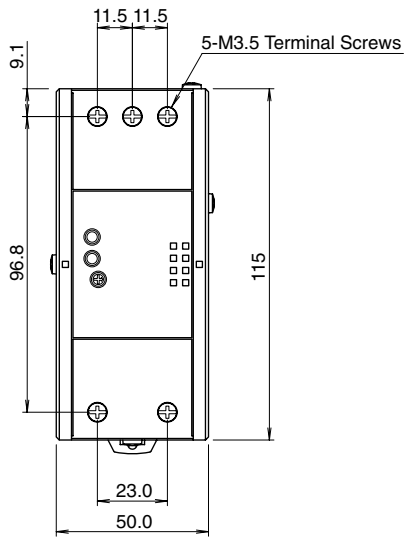

PS9Z-5R1G Panel Mounting Bracket

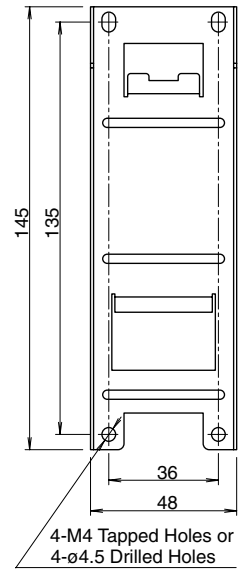

PS5R-SG

PS9Z-5R1G Panel Mounting Bracket

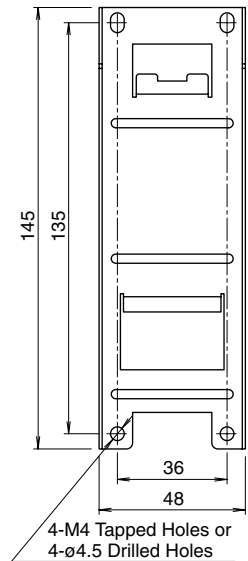
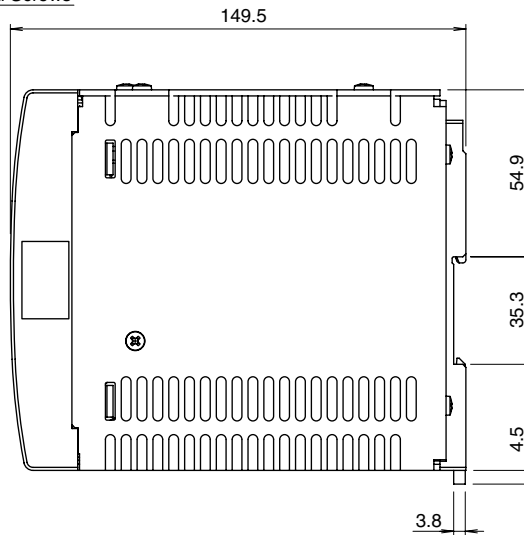
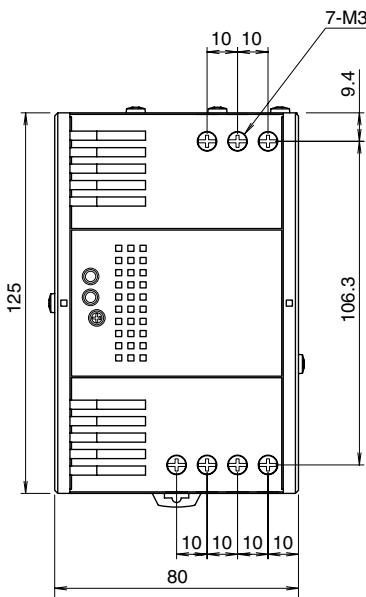

All dimensions in mm.

# PS5R-S Switching Power Supplies

## Parts Description

### PS5R-SB

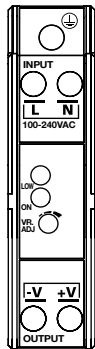

Marking	Name	Description
VR.ADJ	Output Voltage Adjustment	• Allows adjustment within $\pm 10\%$ . Turning clockwise increases the output voltage.
DC ON	Operation Indicator (Green)	• Lights on when the output voltage is on.
DC Low	Output Low Indicator (Amber)	• Lights on when the output voltage drops below approx. 80% of the rated value (PS5R-SB/SF/SG only).
+V -V	DC Output Terminals	• +V: Positive output terminal • -V: Negative output terminal
$\oplus$	Ground Terminal	• Be sure to connect this terminal to a proper ground.
L N	Input Terminal	• Accept a wide range of voltage and frequency. Polarity is irrelevant at DC input.

### PS5R-SC/SD/SE

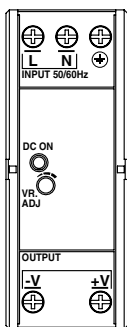

#### DC ON and DC Low Indicators

When the output voltage drops below approx. 80% of the rated value because of the activation of overcurrent protection or low input voltage, the DC Low LED goes on (PS5R-SB/SF/SG only).

The status of the switching power supply can be seen from the DC ON and DC Low indicators.

Status	Normal	Overload or Input Voltage Low*	Output Short-circuit	Output OFF
DC ON LED (Green)	ON	ON	OFF	OFF
DC Low LED (Amber)	OFF	ON	ON	OFF

### PS5R-SF/SG

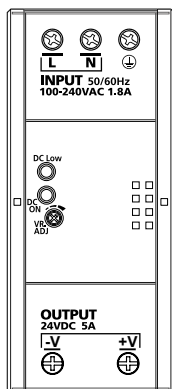

\* The LEDs go on when the input voltage drops below 57V AC at full load.

## Safety Precautions

- Do not use switching power supplies with electric equipment whose malfunction or inadvertent operation may damage the human body or life directly.
- Make sure that the input voltage and output current do not exceed the ratings. If the input voltage and output current exceed the ratings, electric shock, fire, or malfunction may occur.
- Do not touch the terminals of the switching power supply while input voltage is applied, otherwise electric shock may occur.
- Provide the final product with protection against malfunction or damage that may be caused by malfunction of the switching power supply.
- Operating temperatures should not exceed the ratings. Be sure to note the derating characteristics. If the operating temperature exceeds the ratings, electric shock, fire, or malfunction may occur.
- Blown fuses indicate that the internal circuits are damaged. Contact IDEC for repair. Do not just replace the fuse and reoperate, otherwise electric shock, fire, or malfunction may occur.
- Do not use the switching power supplies to charge rechargeable batteries.
- Connect all output terminals on the pin terminal type, otherwise fire may occur.
- Do not overload or short-circuit the switching power supply for a long period of time, otherwise the internal elements may be damaged.
- Do not disassemble, repair, or modify the power supplies, otherwise the high voltage internal part may cause electric shock, fire, or malfunction.

## Instructions

### Notes for Installation

1. When mounting the PS5R-S switching power supply, be sure to prevent heat built-up around the PS5R-S, taking the following precautions into consideration.

- (1) Do not close the top and bottom openings of the PS5R-S to allow for heat radiation by convection.

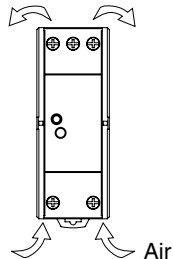

- (2) Maintain a minimum of 20 mm clearance around the PS5R-S, except for the top and bottom openings.
  - (3) When derating of the output does not work, provide forced air-cooling.
  - (4) For wiring, use wires with heat resistance of 60°C or higher.
  - (5) Recommended tightening torque of the input and output terminals is 0.8 N·m (UL listed torque value). Do not tighten to 1.8 N·m or higher.
  - (6) Use copper core wires of the following sizes.  
Recommended wire size: AWG14 to 18  
(cross section: 0.9 to 2 mm<sup>2</sup>)
2. When mounting multiple PS5R-S switching power supplies side by side, maintain a minimum of 20 mm clearance. Observe the derating curves in consideration of the ambient temperature.

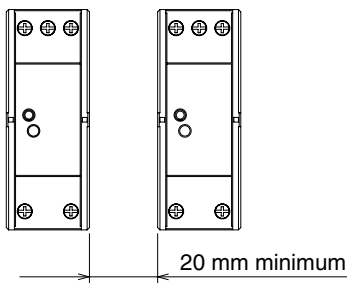

### 3. Mounting on 35-mm-wide DIN rails

#### Mounting

Fasten the DIN rail to a mounting plate using screws firmly. When mounting the PS5R-S on a DIN rail, place the PS5R-S as shown. With the clamp inserted, press the PS5R-S towards the DIN rail.

#### Removal

Insert a flat screwdriver into the slot in the clamp, and pull out the clamp until it clicks. Turn the PS5R-S bottom out.

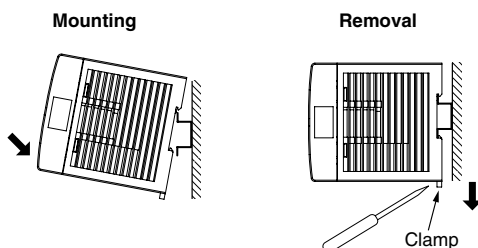

### 4. Installing the Panel Mounting Bracket

#### <Installing PS9Z-5R1 Panel Mounting Bracket>

##### Panel Mounting Bracket (PS9Z-5R1)

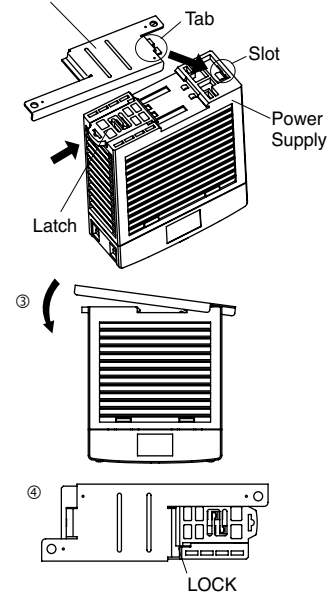

- ① Push in the latch to LOCK position.

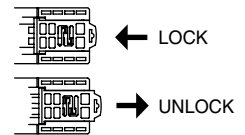

- ② Insert the tab on the panel mounting bracket into the slot on the power supply.

- ③ Install the bracket as shown on the left.

- ④ Ensure that the panel mounting bracket is locked by the latch.

#### <Installing PS9Z-5R2B Panel Mounting Bracket>

##### Panel Mounting Bracket (PS9Z-5R2B)

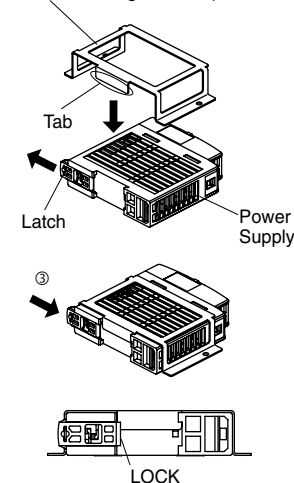

- ① Pull out the latch to UNLOCK position.

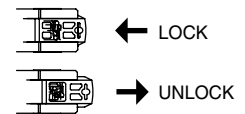

- ② Insert the tab on the panel mounting bracket into the slot on the power supply.

- ③ Push in the latch to LOCK position.

- ④ Ensure that the panel mounting bracket is locked by the latch.

# PS5R-S Switching Power Supplies

## Instructions

### Adjustment of Output Voltage

The output voltage can be adjusted within  $\pm 10\%$  of the rated output voltage by using the VR.ADJ control on the front. Turning the VR.ADJ clockwise increases the output voltage. When using a higher output voltage, reduce the output current to make sure that the output capacity is within the rating. Note that overvoltage protection may work when increasing the output voltage.

### Overcurrent Protection

The output voltage drops automatically when an overcurrent flows due to an overload or short circuit. Normal voltage is automatically restored when the load returns to normal conditions.

### Overvoltage Protection (OVP)

The output is turned off by overvoltage protection when an overvoltage is applied. When the output voltage has dropped due to an overvoltage, turn the input off, and after one minute, turn the input on again.

### Insulation/Dielectric Test

When performing an insulation/dielectric test, short-circuit the input (between L and N) and output (between +V and -V). Do not apply or interrupt the voltage quickly, otherwise surge voltages may be generated and the PS5R-S may be damaged.

### Series Operation

The following series operation is allowed. (When UL1310 Class 2 is applied, series operation is not allowed.)

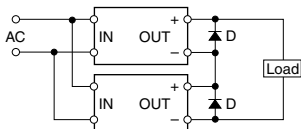

Connect Schottky diodes D as shown above. Select Schottky diodes in consideration of the rated current.

### Parallel Operation

Parallel operation is not possible to increase the output capacity, because the internal elements and load may be damaged.

### Backup Operation

Backup operation is a connection method of two switching power supplies in parallel for emergency. Normally one switching power supply has a sufficient output. If one switching power supply fails, another one operates to continue the output. Make sure that the sum of power consumption by load and diode is not greater than the rated wattage (rated voltage  $\times$  rated current) of one switching power supply.

### Notes for Operation

1. Output interruption may indicate blown fuses. Contact IDEC.
2. The PS5R-S switching power supply contains an internal fuse for AC input. When using with DC input, install an external fuse for DC input. To avoid blown fuses, select a fuse in consideration of the rated current of the internal fuse.

Specifications and other descriptions in this brochure are subject to change without notice.

### Rated Current of Internal Fuses

Part No.	Internal Fuse Rated Current
PS5R-SB	2A
PS5R-SC PS5R-SD	3.15A
PS5R-SE PS5R-SF	4A
PS5R-SG	6.3A

3. Avoid overload and short-circuit for a long period of time, otherwise the internal elements may be damaged.
4. DC input operation is not subject to safety standards.

### Rust and Scratches on Housing, Frame, and Metal Parts

Bonderized steel plate and hot-dip galvanized steel plates used for the PS5R-S switching power supplies may develop scratches on the surface or rust on the edge, depending on the storage condition.

### Ordering Information

- When ordering, specify the Part No. and quantity.

### Warranty

#### Period

IDEC warrants the PS5R-S switching power supply for a period of three years from the date of shipment.

#### Scope

IDEC agrees to free repair or replacement of the PS5R-S switching power supply if the product has been operated under the following conditions.

1. Average operating temperature (ambient temperature of switching power supply) is 40°C at maximum.
  2. The load is 80% at maximum.
  3. Input voltage is the rated input voltage.
  4. Standard mounting style
- IDEC shall not be liable for other damages including consequential, contingent or incidental damages. Warranty does not apply if the PS5R-S switching power supply was subject to:
1. Inappropriate handling, or operation beyond the specifications.
  2. Modification or repair by other than IDEC.
  3. Failure caused by other than the PS5R-S switching power supply.
  4. Failure caused by natural disasters.



## IDEC CORPORATION

6-64, Nishi-Miyahara 2-Chome, Yodogawa-ku, Osaka 532-0004, Japan  
Tel: +81-6-6398-2527, Fax: +81-6-6398-2547  
E-mail: marketing@idec.co.jp

**IDEC CORPORATION (USA)**  
1175 Elko Drive, Sunnyvale, CA 94089-2209, USA  
Tel: +1-408-747-0550 / (800) 262-IDEAC (4332)  
Fax: +1-408-744-9055 / (800) 635-6246  
E-mail: opencontact@idec.com

**IDEC CANADA LIMITED**  
3155 Pepper Mill Court, Unit 4  
Mississauga, Ontario, L5L 4X7, Canada  
Tel: +1-905-890-8561, Toll Free: (888) 317-IDEAC (4332)  
Fax: +1-905-890-8562  
E-mail: sales@ca.idec.com

**IDEC AUSTRALIA PTY. LTD.**  
Unit 17, 104 Ferntree Gully Road,  
Oakleigh, Victoria 3166, Australia  
Tel: +61-3-8523-5900, Toll Free: 1800-68-4332  
Fax: +61-3-8523-5999  
E-mail: sales@au.idec.com

**IDEC ELEKTROTECHNIK GmbH**  
Heselerstrucken 8, 22453 Hamburg, Germany  
Tel: +49-40-25 30 54 - 0, Fax: +49-40-25 30 54 - 24  
E-mail: service@eu.idec.com

**IDEC (SHANGHAI) CORPORATION**  
Room 701-702 Chong Hing Finance Center,  
No. 288 Nanjing Road West, Shanghai 200003, PRC  
Tel: +86-21-6135-1515  
Fax: +86-21-6135-6225 / +86-21-6135-6226  
E-mail: idecS@cn.idec.com

**IDEC (BEIJING) CORPORATION**  
Room 211B, Tower B, The Grand Pacific Building,  
8A Guanghua Road, Chaoyang District,  
Beijing 100026, PRC  
Tel: +86-10-6581-6131, Fax: +86-10-6581-5119

**IDEC (SHENZHEN) CORPORATION**  
Unit AB-3B2, Tian Xiang Building, Tian'an Cyber Park,  
Fu Tian District, Shenzhen, Guang Dong 518040, PRC  
Tel: +86-755-8356-2977, Fax: +86-755-8356-2944

**IDEC IZUMI (H.K.) CO., LTD.**  
Unit G & H, 26/F., MG Tower, No. 133 Hoi Bun Road,  
Kwun Tong, Kowloon, Hong Kong  
Tel: +852-2803-8989, Fax: +852-2565-0171  
E-mail: info@hk.idec.com

**IDEC TAIWAN CORPORATION**  
8F-1, No. 79, Hsin Tai Wu Road, Sec. 1,  
Hsi-Chih District, 22101 New Taipei City, Taiwan  
Tel: +886-2-2698-3929, Fax: +886-2-2698-3931  
E-mail: service@tw.idec.com

**IDEC IZUMI ASIA PTE. LTD.**  
No. 31, Tannery Lane #05-01,  
HB Centre 2, Singapore 347788  
Tel: +65-6746-1155, Fax: +65-6844-5995  
E-mail: info@sg.idec.com

**IDEC ASIA (THAILAND) CO., LTD.**  
20th Fl., Sorachai Bldg., No.23/78,  
Soi Sukhumvit 63, Sukhumvit Rd.,  
Klongton-nua, Wattana, Bangkok 10110  
Tel: +662-392-9765, Fax: +662-392-9768  
E-mail: sales@th.idec.com