

HR1S-ATE Safety Relay Modules

New compact safety relay modules. Size is reduced by 50% from conventional models. Plug-in terminal structure enables simple wiring.

- EN ISO 13849-1 performance level e, safety category 4 compliant, and EN 62061 safety integrity level 3.
- Integrated and removable terminal styles available.
- Compact design: 45 mm in width.
- Time delay outputs: 3NO
- Auxiliary output enables power supply monitoring, inputs (2 channels), and a time delay output.
- UL Listed, CSA certified, TÜV NORD approved.

Package Quantity: 1

Part No.	Terminal Style
HR1S-ATE5110	Integrated Terminal Block
HR1S-ATE5110P	Removable Terminal Block

Specifications

Applicable Standards	EN 60204-1: 2006 EN 60947-1: 2007 EN 60947-5-1:2004 EN 61000-6-2: 2005 EN 61000-6-4: 2007 EN 62061: 2005 EN ISO 13849-1: 2008 EN ISO 13849-2: 2008	
Applicable Standards for Use	EN 60204-1: 2006 EN ISO 13850: 2008	
Performance level (PL)	e (EN ISO 13849-1)	
Safety Category	4 (EN ISO 13849-1)	
Safety Integrity Level (SIL)	3 (EN 62061)	
Stop Category	0, 1 (EN 60204-1) (Note)	
Operating Temperature	-10 to +55°C (no freezing)	
Relative Humidity	30 to 85% RH (no condensation)	
Impulse Withstand Voltage	4 kV (IEC 60947-5-1)	
Shock Resistance	150 m/s ² , 11m sec, 3 shocks in each 3 axes	
Vibration Resistance	10 to 60 Hz, amplitude 0.35 mm 60 to 150 Hz, acceleration 50 m/s ²	
Degree of Protection	Terminal: IP20 Enclosure: IP40	
Rated Voltage	24V AC -20% +10% 24V DC -20% +20%	
Power Consumption	24V AC: 8 VA max. 24V DC: 4W max.	
Overcurrent Protection	Built-in, electronic	
Minimal Applicable Load	17V DC / 10 mA (initial value)	
Response Time	ON→OFF: 20 ms max. (Instantaneous output)	
Overvoltage Category	III	
Pollution Degree	2	
Rated Insulation Voltage	300V AC	
No. of Outputs	Safety Circuit	2NO
	Time-delay Circuit	3NO
Auxiliary Circuit	Contact	—
	Transistor	4
Output Contact Ratings	Safety Circuit	AC15 C300 (Ue = 230V AC / Ie = 0.75A) DC13 24V DC / Ie=1A
	Time-delay Circuit	AC15 C300 (Ue = 230V AC / Ie=0.75A)
		DC13 Ue = 24V DC / Ie=1A
	Preset Time	0, 0.5, 1, 2, 4, 6, 8, 10, 15, 20, 25, 30 sec.
	Auxiliary Circuit	24V DC / 20 mA (PNP)
Mechanical Durability	10,000,000 operations	
Electrical Durability	See page 22.	
Rated Current	Total output: 8A max. 1 output 4A max.	

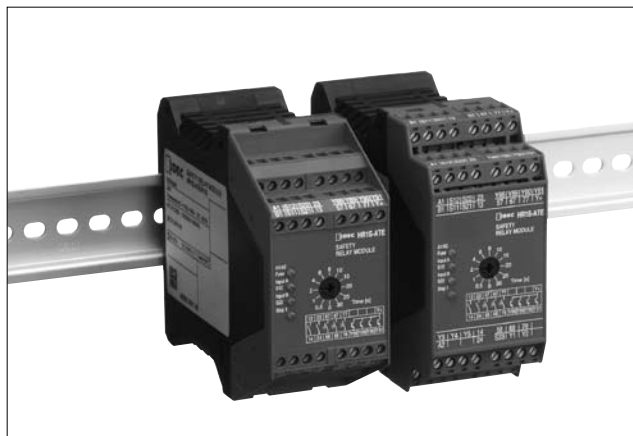

Wire Size	HR1S-ATE5110	Single wire: 0.2 to 2.5 mm ² max. (24–14 AWG) Multiple wires: 0.14 to 0.75 mm ² max.
	HR1S-ATE5110P	Single wire: 0.2 to 2.5 mm ² max. (24–14 AWG) Multiple wires: 0.2 to 1.5 mm ² max.
Weight (approx.)	280g	

Note: Safety output contact Stop category 0
Time-delay output contact Stop category 1

- Use a 4A fuse (Type gG) for power protection. Use a 6A fuse (Type gG) for safety output protection. Use a 4A fuse (Type gG) for time-delay output and auxiliary output protection.

Dimensions

HR1S-ATE5110 Integrated Terminal

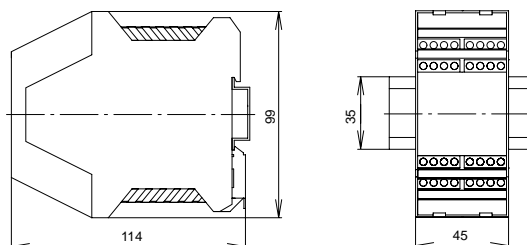

HR1S-ATE5110P Removable Terminal

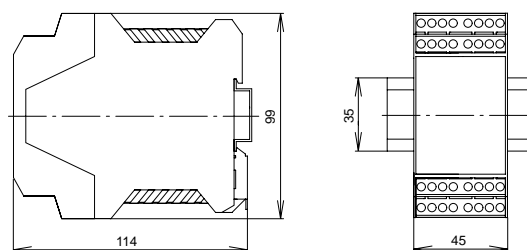

All dimensions in mm.

LED Indicator

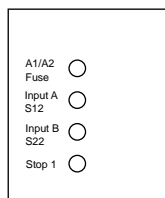

- A1/A2 Fuse: Turns on when power circuit is normal.
- Input A S12: Turns on when S11–S12 is closed.
- Input B S22: Turns on when S21–S22 is closed.
- Stop1: Turns on when the time-delay output circuits 57-58, 67-68, and 77-78 are closed.

HR1S-ATE Safety Relay Modules

Wiring Diagram

Safety Category 4 (3) Circuit (using an emergency stop switch) (Note)

Safety category is achieved by an entire control system. Take the connected safety equipment and wiring into consideration.

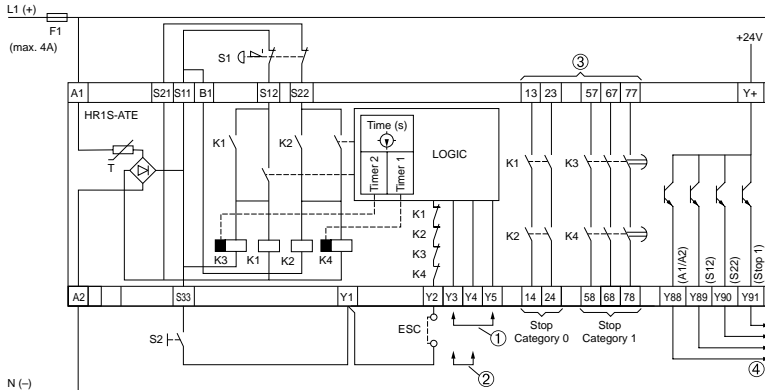

- ① When monitoring the start switch, starts when switched off (default setting/recommended)
 - ② When monitoring the start switch, starts when switched on
 - ③ Outputs must be fused (see the instruction manual for maximum fuse size)
 - ④ To PLC, etc.
- Note: When using off-delay output, safety category becomes 3.

- S1 = Emergency stop switch with 2 NC contacts (recommended)
- S2 = Start switch
- ESC = External start conditions
- Y1 (S33) – Y2 = Feedback loop

When not monitoring the start switch (Y3-Y4 short-circuited) (automatic start when S33-Y2 is short-circuited)

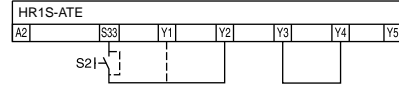

When monitoring the start switch (Y3-Y5 short-circuited)

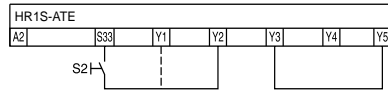

Emergency stop switch - Input 1 channel When not detecting short-circuit (All failures such as short-circuit of emergency stop switch wiring not detected)

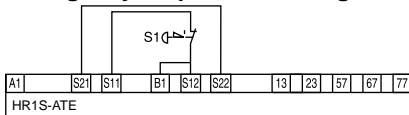

Emergency stop switch - Input 2 channels When not detecting short-circuit (B1-S12 short-circuit not detected)

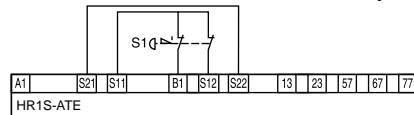

Safety Category 3 Circuit (using multiple emergency stop switches)

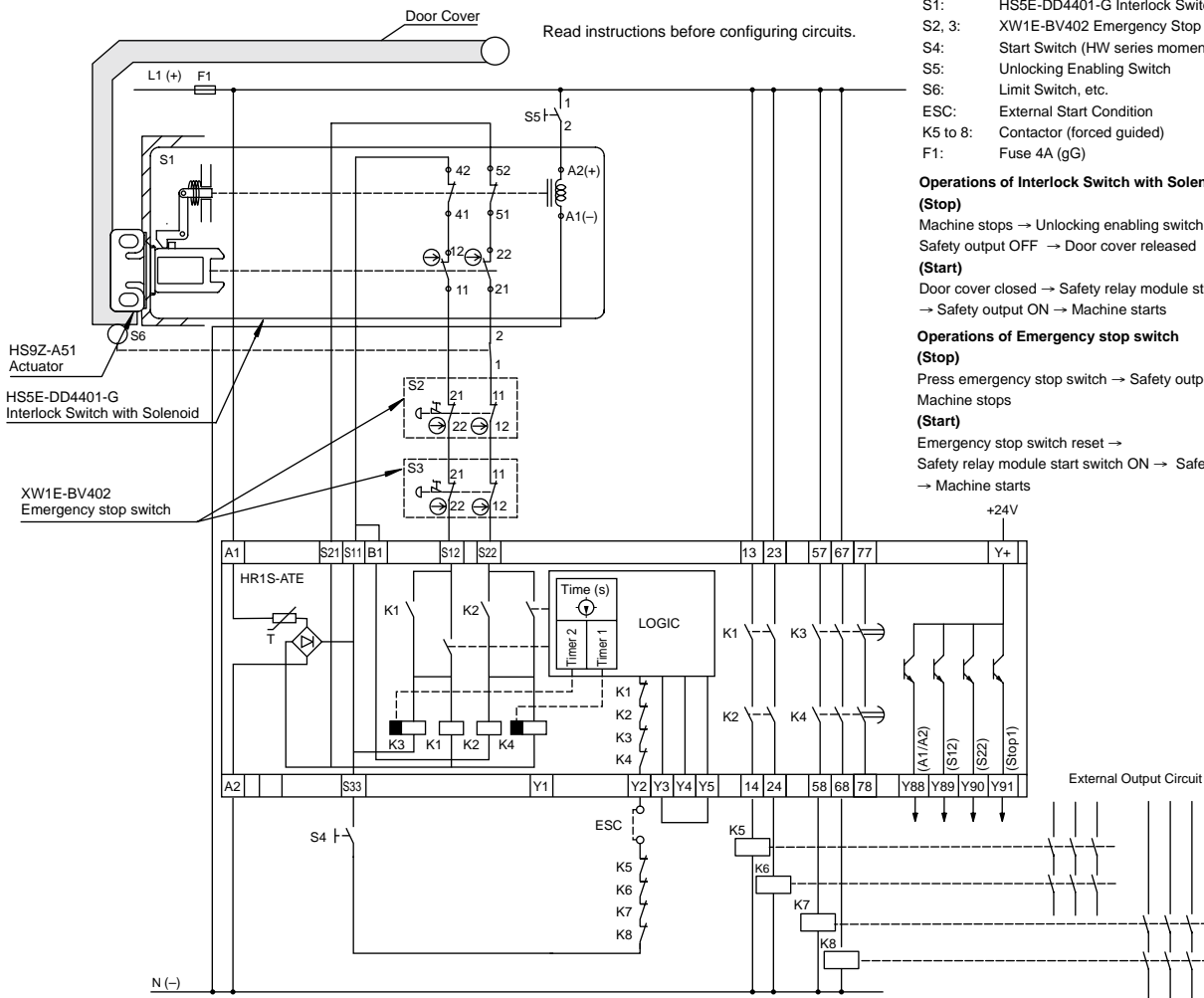

Read instructions before configuring circuits.

- S1: HS5E-DD4401-G Interlock Switch with Solenoid
- S2, 3: XW1E-BV402 Emergency Stop Switch
- S4: Start Switch (HW series momentary)
- S5: Unlocking Enabling Switch
- S6: Limit Switch, etc.
- ESC: External Start Condition
- K5 to 8: Contactor (forced guided)
- F1: Fuse 4A (gG)

Operations of Interlock Switch with Solenoid

(Stop)

Machine stops → Unlocking enabling switch ON → Safety output OFF → Door cover released

(Start)

Door cover closed → Safety relay module start switch ON → Safety output ON → Machine starts

Operations of Emergency stop switch

(Stop)

Press emergency stop switch → Safety output OFF → Machine stops

(Start)

Emergency stop switch reset → Safety relay module start switch ON → Safety output ON → Machine starts

Operation Chart

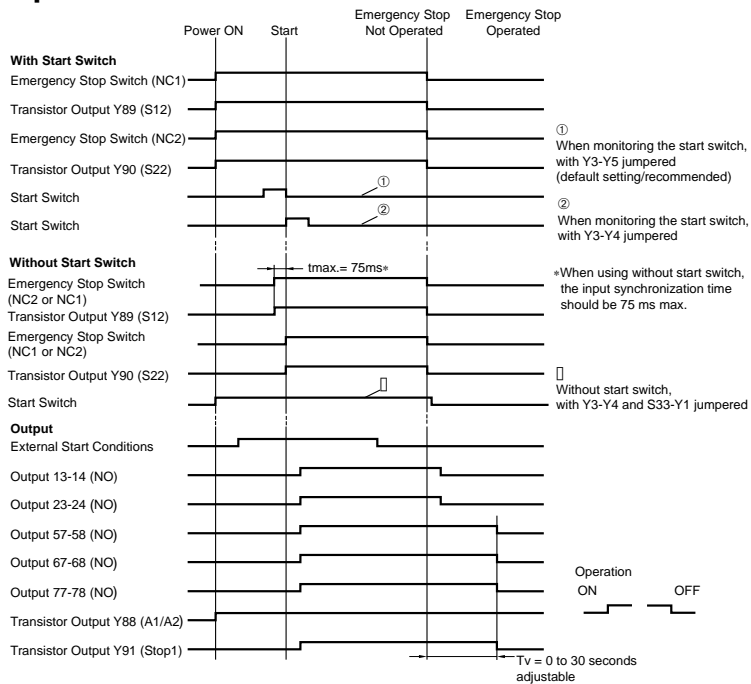

Output Contact Electrical Life

(Safety Circuit, Time-delay Circuit, Auxiliary Circuit)

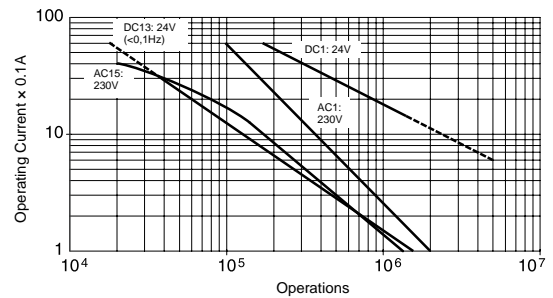

Residual Risk (EN ISO/ISO12100-1)

The wiring diagrams on page 21 have been tested under actual operating conditions. The HR1S-ATE safety relay module can be used in a safety circuit by connecting to safety equipment compliant to applicable standards. Consider residual risk in the following circumstances:

a) When it is necessary to modify the recommended circuit and if added/modified components are not properly integrated into the control circuit.

b) When applicable standards of machine operation are not observed, or when the machine is not adjusted or maintained properly (adhere to a strict maintenance schedule).
c) When the contacts of relays and contactors for connected with safety outputs are not forced guided (compliant with EN 50205).

Instructions

- Only persons with technical expertise may install, startup, modify, or retrofit the HR1S-ATE safety relay module.
- Turn the power off before installation, removal, wiring, maintenance, or inspection of the safety relay module. If an error occurs, line voltage may be present at the control circuit in devices without DC isolation.
- Observe all electrical safety regulations issued by appropriate technical authorities or trade association. The safety function can be lost if the device is not used for its intended purpose.
- Do not open the housing or perform invalid operation, otherwise the warranty will become voided.
- Negligence to observe the following instructions may cause accidents that may result in death or serious injuries.
- Connect the wires according to the wiring diagrams shown on page 21.
- Connect the wires according to applicable standards.
- The contacts of relays and contactors to connected with safety outputs must be forced guided (compliant with EN 50205).
- For external fusing, use an appropriate fuse size and connect according to the wiring diagram on page 21.
- When maintaining or adjusting machines, observe the maintenance schedule.
- If the recommended circuit is modified or if components are added/modified, make sure that they are properly integrated into the control circuit.
- Relays must have mechanically-linked contacts.
- Follow required standards applicable to the operation of the machine. When maintaining or adjusting machines, observe a proper maintenance schedule.

- Do not use the module if it has been subjected to improper or incorrect use. In this case, the warranty will be voided.
- Do not use the HR1S-ATE under stressful conditions such as irregular voltage, current, temperature, or humidity.
- Before starting up your equipment for the first time, be sure to check all safety functions according to regulations and observe the specified test cycles for safety equipment.
- Perform the following precautionary steps prior to installation, assembly, or disassembly of the system.
 1. Disconnect the supply voltage to the equipment / system prior to starting work.
 2. To prevent accidental activation of the module or system, perform lock-out or tag-out.
 3. Make sure that no voltage is applied.
 4. Ground N (–) as shown in the wiring diagram on page 21.
 5. Protect against adjacent operating components using guards or barriers.
 6. The devices must be installed in a cabinet with a protection class of at least IP54.
- Contact Protection
 - Type of protection according to EN/IEC 60529
 - Housing / Terminals: IP40 / IP20
 - Finger-safe protection according to EN 50274
- Connect external fuse according to the wiring diagram on page 21.