











MA/MC Series Control Units





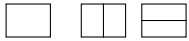

MA Series Selection Guide

Series	MA Series Miniature Control Units		
Unit	Illuminated Pushbutton (including Pilot Light)		
Model	MA2L/MA2P	MA3L/MA3P	MA8L/MA8P
Shape	 Square	 Horizontal Rectangular	 Round
Bezel Size (Button/Lens Size)	18 × 18 mm (13 × 13 mm)	18 × 24 mm (13 × 19 mm)	ø23.8 mm (ø19 mm)
Light Source	LED unit	LED unit	LED unit
No. of Light Sources	1	1	1
Illumination Face Division	Full Illumination 2-color Alternate 	Full Illumination 2-color Alternate  Two-way Split 	Full Illumination 
Illumination Color/ Button Color	Amber, Green, Pure White, Red, Blue, White, Yellow		
Operation	Momentary, maintained, pilot light		
Contact	Contact Specifications	Gold contact or silver contact microswitch (SPDT or DPDT)	
	No. of Contacts	One or two contacts	
	Contact Ratings (Resistive Load)	Gold contact: 30V DC/0.1A, 125V AC/0.1A Silver contact: 125V AC/5A, 250V AC/3A, 30V DC/5A, 125V DC/1.1A	
Life	Mechanical	Momentary: 1,000,000 operations minimum, Maintained: 200,000 operations minimum	
	Electrical	100,000 operations minimum (Switching frequency: 1200 operations/hour)	
Housing Color	Black		
Terminal Style	Solder/tab terminal #110		
Accessories	<ul style="list-style-type: none"> • Switch guard • Guard barrier • Barrier • Dust cover • Socket (Solder terminals/PC board terminals) • Dummy unit 		<ul style="list-style-type: none"> • Socket (Solder terminals) (PC board terminals)
Remarks	<ul style="list-style-type: none"> • Light-touch operation • Super bright LED unit • Built-in current limiting resistor and diode (in LED unit) • Two-way split illumination (MA3 only) 		
Approvals	UL, c-UL, CE, CCC		
See Page	7	8	10

MA Series Selection Guide

MA Series Miniature Control Units			
Pushbuttons			Illuminated Pushbutton/ Pushbutton
MA2B	MA3B	MA8B	MA Combination
			
Square	Horizontal Rectangular	Round	
18 × 18 mm (13 × 13 mm)	18 × 24 mm (13 × 19 mm)	ø23.8 mm (ø19 mm)	
—	—	—	LED unit, or none
—	—	—	—
—	—	—	Full Illumination, or Two-way Split 
Button: black, green, red, blue, white, yellow Lens: amber, green, red, blue, white, yellow			Illuminated pushbutton: amber, green, pure white, red, white, yellow Pushbutton: black, green, red, blue, white, yellow
Momentary, maintained			Momentary, maintained, pilot light
Gold contact or silver contact microswitch (SPDT or DPDT)			
One or two contacts			
Gold contact: 30V DC/0.1A, 125V AC/0.1A Silver contact: 125V AC/5A, 250V AC/3A, 30V DC/5A, 125V DC/1.1A			
Momentary: 1,000,000 operations minimum, Maintained: 200,000 operations minimum			
100,000 operations minimum (Switching frequency: 1200 operations/hour)			
Black			
Solder/tab terminal #110			
<ul style="list-style-type: none"> • Switch guard • Guard barrier • Barrier • Dust cover • Socket (Solder terminals/PC board terminals) • Dummy unit 		<ul style="list-style-type: none"> • Socket (Solder terminals) (PC board terminals) 	<ul style="list-style-type: none"> • Dummy unit
<ul style="list-style-type: none"> • Light-touch operation 		<ul style="list-style-type: none"> • Combination type with several units mounted in special frame • Maximum No. of units MA2: 4 rows × 12 columns MA3: 4 rows × 9 columns 	
UL, c-UL, CE, CCC (except pilot lights)			—
11			21

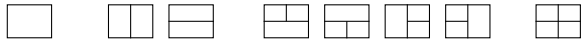
MC Series Selection Guide

Series		MC Series Illuminated Control Units		
Model		MC3D		MC2D
Shape				
	Rectangular Horizontal / Barrier		Rectangular Horizontal / Flange	Square / Flange
Front Size (Button/Lens Size)	25 × 32 mm (18.8 × 26.7 mm)		25 × 32 mm (18.8 × 26.7 mm)	25 × 25 mm (18.8 × 18.8 mm)
Light Source	LED Lamp (IDEC's LFTD) <u>or incandescent lamp (0.5W) (IDEC's LH)</u> with SX6S/8 lamp base			
No. of Lamps	Full illumination: 2 (LED <u>or incandescent</u>) Vertical 2-way split: 2 (LED) Horizontal 2-way, 3-way, 4-way split: 4 (LED)			Full: 1 (LED <u>or incandescent</u>) Horizontal 2-way split: 2 (LED)
Illumination Face Division	<p style="text-align: center;"> Full illumination 2-way split 3-way split 4-way split </p> 			<p style="text-align: center;"> Full illumination 2-way split </p> 
Illumination Color	Amber, Green, Pure White, Red, Blue, White, Yellow			
Operation Type	Momentary (snap action, slow action), maintained, pilot light			
Contact	Contact Specifications	Silver contact or gold contact microswitch (SPDT)		
	No. of Contacts	One to three contacts		One or two contacts
	Contact Ratings (Resistive Load)	Silver contact: 125V AC/5A, 250V AC/3A, 30V DC/5A, 125V DC/1.1A Gold contact: 5V AC/DC, 1 mA (minimum current reference value)		
Life	Mechanical	Momentary: 1,000,000 operations minimum, Maintained: 250,000 operations minimum		
	Electrical	100,000 operations minimum		
Housing Color	Black, gray			
Terminal Style	Solder/tab terminal #110 (compatible with quick-connect receptacles), PC board terminals			
Accessories	<ul style="list-style-type: none"> • Socket (solder terminals/PC board terminals) • Switch guard • Barrier • Guard barrier • Dustproof cover • Terminal cover • Vertical mounting leaf spring 			
Remarks	<ul style="list-style-type: none"> • <u>LED and incandescent lamps can be used (incandescent lamps for full illumination only).</u> • LED lamps contain a current limiting resistor and diode (in LED unit). • Color screens are separately ordered. 			
Approvals	UL, c-UL, TV, CE, CCC (except pilot lights)			
See Page	26		27	28

MA Series Miniature Control Units

Super bright LED for AC/DC

Square-, rectangular-, and round-body, miniature control units

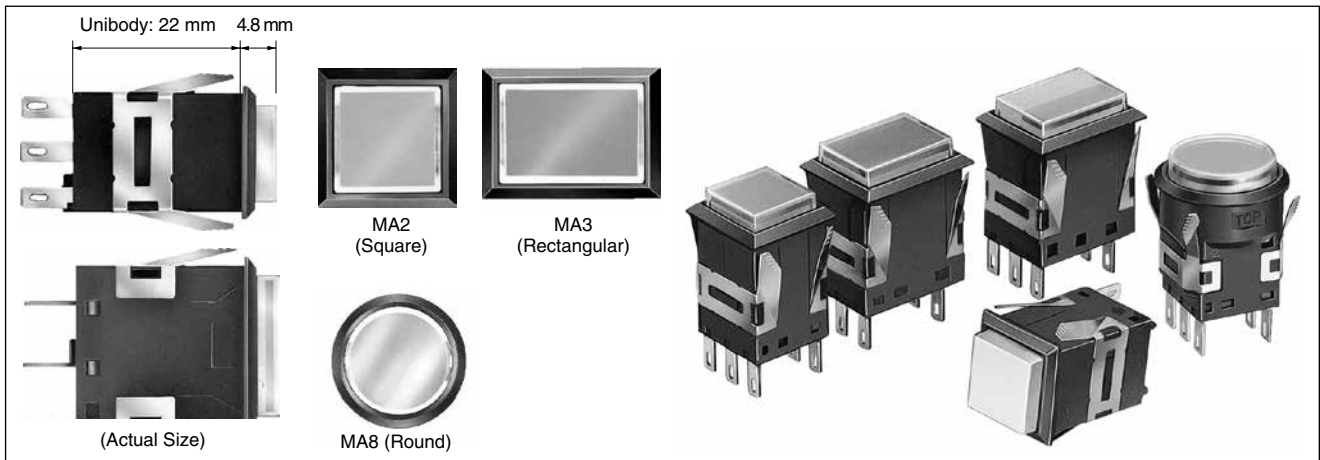

Features

- Compact and space-saving (unibody: 22 mm)
- Super-bright LED unit
- Gold-clad silver cross-bar contacts for low-level signal switching integrity
- Also available with silver contacts
- High-performance contact mechanism
- Light-touch operation
- Built-in current limiting resistor and diode (LED)
- Quick installation into panel (front mounting)
- Optional barrier, switch guard, and socket
- UL/cUL-recognized, EN compliant

Applicable Standards	Mark	File No. or Organization
UL508 CSA C22.2 No.14		UL File No. E55996
EN60947-1 EN60947-5-1		EU Low Voltage Directive
GB14048.5		2006010305180958 (MA2) 2006010305180973 (MA3) 2006010305180950 (MA8) (except pilot lights)

MA Series

Item	MA2 (Square)	MA3 (Rectangular)	MA8 (Round)
Bezel Size	 □18 mm	 18H × 24W mm	 ø23.8 mm
Illumination Face Size	□13 mm	13H × 19W mm	ø19 mm
Light Source	LED		
Illumination Face Division (Note)	One-color Full, Two-way Split, Two-color Full Alternate		
Contact	Microswitch (Gold-clad silver/cross bar contact, Silver contact)		
No. of Contacts	SPDT or DPDT		
Operation Type	Momentary, maintained, pilot light		
Terminal Style	Solder/tab terminal #110		
Housing Color	Black		

Note: Two-way split illumination is available for MA3 (rectangular type) only.
Two-color alternate illumination is available for MA2 and MA3 only.

Illumination Ratings

Item	One-color Full/Two-way Split			Two-color Full Alternate
Operating Voltage	5V DC ±5%	12V AC/DC ±5%	24V AC/DC ±5%	24V AC/DC ±5%
Rated Voltage	5V DC	12V AC/DC	24V AC/DC	24V AC/DC
Rated Current	See the circuit of the LED unit.			
Life (Reference Value)	Approx. 30,000 hours (The luminance reduces to 50% of the initial intensity when used on complete DC.)			

Note: Built-in current limiting resistor and diode are supplied.

Contact Ratings

Gold Contact (Switch Base: Blue)

Rated Insulation Voltage	250V		
Rated Current	3A		
Rated Voltage	30V DC	125V AC	
Rated Operating Current (Resistive Load)	0.1A	0.1A	
Contact Material	Gold-clad silver		

- Minimum applicable load (reference value): 5V AC/DC, 1mA

Silver Contact (switch base: gray)

Rated Insulation Voltage	250V					
Rated Operating Voltage				30V	125V	250V
Rated Operating Current	Specifica-tion 1*	AC 50/60Hz	Resistive load	—	5A	5A
			Inductive load	—	3A	1.5A
		DC	Resistive load	5A	1.1A	—
	Specifica-tion 2*	AC 50/60Hz	Resistive load	—	5A	3A
			Inductive load	—	3A	1.5A
		DC	Resistive load	3A	0.6A	—
		Inductive load	1A	0.22A	—	
Rated Thermal Current	5A					
Contact Material	Silver					

- AC inductive load: PF=0.6 to 0.7 DC inductive load: L/R=7 ms max.
- * See Specifications for electrical life.

Specifications

Operating Temperature	-25 to +55°C (no freezing)	
Storage Temperature	-40 to +80°C (no freezing)	
Relative Humidity	35 to 85% RH (no condensation)	
Contact Resistance	50 mΩ maximum (initial value)	
Insulation Resistance	100 MΩ minimum (500V DC megger)	
Dielectric Strength	Switch	Between live and dead parts: 2000V AC, 1 minute Between terminals of different poles: 2000V AC, 1 minute Between contact terminals of the same pole: 1000V AC, 1 minute Between contact terminal and lamp terminal: 2000V AC, 1 minute
	Illumination Unit	Between live part and ground: 2000V AC, 1 minute
Vibration Resistance	Operating extremes: 10 to 55 Hz, amplitude 0.75 mm	
Shock Resistance	Damage limits: 500 m/s ² Operating extremes: 200 m/s ²	
Mechanical Life	Momentary: 1,000,000 operations minimum Maintained: 200,000 operations minimum	
Electrical Life	50,000 operations minimum (rated operating current: specification 1) 100,000 operations minimum (rated operating current: specification 2) *50,000 operations minimum when using silver contacts at 125V/5A resistance load (UL rating)	
Degree of Protection	IP40 (IEC 60529)	

MA Series Miniature Control Units

One-color Full Illumination Amber, green, red, blue, white, yellow	Two-way Split Illumination Green, red, white (MA3 only)	Two-color Full Alternate Illumination Red ↔ Green		
<p>Lens (Transparent, non-reflective)</p> <p>Color Screen (Amber, green, red, blue, yellow, transparent)</p> <p>Marking Plate (White acrylic plate)</p> <p>Lens Holder</p> <p>LED Unit (Amber, green, red, blue, white, yellow)</p>	<p>Lens (Transparent, non-reflective)</p> <p>Color Screen (Green, red, transparent)</p> <p>Marking Plate (White acrylic plate)</p> <p>Light Barrier</p> <p>Lens Holder</p> <p>LED Unit (Red, green, white)</p>	<p>Lens (Transparent, non-reflective)</p> <p>Marking Plate (White acrylic plate)</p> <p>Lens Holder</p> <p>LED Unit (24V DC) (Red/Green Two-color alternate illumination)</p>		
<p>Note: The above figure shows MA3. MA2 also has the same configuration.</p>	<p>Note: The above figure shows the short two-way split type. The long two-way split type also has the same configuration.</p>	<p>Note: The above figure shows MA3. MA2 also has the same configuration.</p>		
<p>MA2 (Square) MA3 (Rectangular) MA8 (Round)</p>				

Ordering Information

When ordering the MA series, specify the Part No.

1. The color plate, marking plate and LED unit are contained within the MA series.
2. Optional accessories (barrier, switch guard, socket, etc.) are available. When ordering, specify the Part No.
3. Use a PW (pure white) LED unit for yellow illumination.

Part No. Development



MA 3 L - M 1 3 4 1 R

Bezel/Illumination Face Size 2 Square (18 × 18) 13 × 13 3 Rectangular (18 × 24) 13 × 19 8 Round (ø23.8) ø19	Operation M Momentary A Maintained blank Pilot light	Housing (Black) 1 MA2/MA8 3 MA3	Illumination Face Division 1 Full 2 Long Two-way Split 3 Short Two-way Split 4 Two-color Alternate 9 Non-illuminated	Lens/Button Color A Amber B Black G Green PW Pure White R Red S Blue W White Y Yellow
Function L Illuminated pushbutton B Pushbutton P Pilot light	Contacts 1 SPDT (gold) 2 DPDT (gold) 5 SPDT (silver) 6 DPDT (silver) blank No contact	Rated Operating Voltage 1 5V DC 3 12V AC/DC 4 24V AC/DC blank Non-illuminated	<ul style="list-style-type: none"> • MA2 provides "Full Illumination" and "Two-color Alternate" illumination only. • MA8 provides "Full Illumination" only. • Combinations of "Two-way Split" illumination colors are R/G, R/W, G/W and W/W only. • Combination of "Two-color Alternate" illumination colors is R/G only. • "B" applies to pushbuttons only. • "A" applies to illuminated pushbuttons and pilot lights only. • "PW" is for 24V AC/DC only. 	

MA Series Illuminated Pushbuttons / Pilot Lights

MA2 Illuminated Pushbuttons / Pilot Lights

Package Quantity: 1

Shape	Operation	Contact Material	Operating Voltage	Contact	Part No.	Illumination Color Code	
MA2 (Square) One-color Full 	Momentary	Gold	24V AC/DC ±5%	SPDT	MA2L-M1141 *	Specify an illumination color code in place of * in the Part No. A: amber G: green PW: pure white R: red S: blue W: white Y: yellow	
				DPDT	MA2L-M2141 *		
			12V AC/DC ±5%	SPDT	MA2L-M1131 *		
				DPDT	MA2L-M2131 *		
			5V DC ±5%	SPDT	MA2L-M1111 *		
				DPDT	MA2L-M2111 *		
		Silver	24V AC/DC ±5%	SPDT	MA2L-M5141 *		
				DPDT	MA2L-M6141 *		
			12V AC/DC ±5%	SPDT	MA2L-M5131 *		
				DPDT	MA2L-M6131 *		
			5V DC ±5%	SPDT	MA2L-M5111 *		
				DPDT	MA2L-M6111 *		
	Maintained	Gold	24V AC/DC ±5%	SPDT	MA2L-A1141 *		
				DPDT	MA2L-A2141 *		
			12V AC/DC ±5%	SPDT	MA2L-A1131 *		
				DPDT	MA2L-A2131 *		
			5V DC ±5%	SPDT	MA2L-A1111 *		
				DPDT	MA2L-A2111 *		
		Silver	24V AC/DC ±5%	SPDT	MA2L-A5141 *		
				DPDT	MA2L-A6141 *		
			12V AC/DC ±5%	SPDT	MA2L-A5131 *		
DPDT				MA2L-A6131 *			
5V DC ±5%			SPDT	MA2L-A5111 *			
			DPDT	MA2L-A6111 *			
Pilot Light	—	—	—	MA2P-141 *			
			—	MA2P-131 *			
			—	MA2P-111 *			
MA2 (Square) Two-color Alternate 	Momentary	Gold	24V AC/DC ±5%	SPDT	MA2L-M1144RG	Red (R) ↔ Green (G) alternate illumination	
				DPDT	MA2L-M2144RG		
		Silver	24V AC/DC ±5%	SPDT	MA2L-M5144RG		
				DPDT	MA2L-M6144RG		
	Maintained	Gold	24V AC/DC ±5%	SPDT	MA2L-A1144RG		
				DPDT	MA2L-A2144RG		
		Silver	24V AC/DC ±5%	SPDT	MA2L-A5144RG		
				DPDT	MA2L-A6144RG		
	Pilot Light	—	—	24V AC/DC ±5%	—		MA2P-144RG



Dimensions

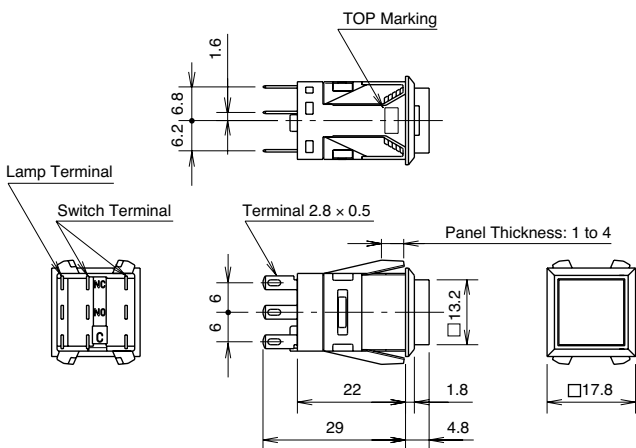

All dimensions in mm.

Terminal Arrangement (Bottom View)

For internal circuit, see page 16.

Full Illumination

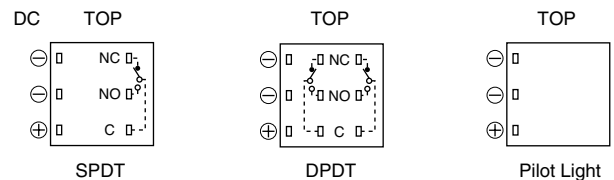



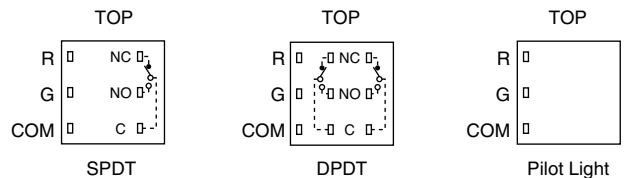

Two-color Alternate Illumination



MA Series Illuminated Pushbuttons / Pilot Lights

MA3 Illuminated Pushbuttons / Pilot Lights

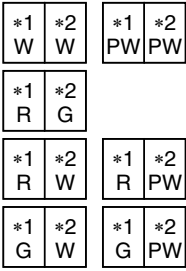
Package Quantity: 1





Shape	Operation	Contact Material	Operating Voltage	Contact	Part No.	Illumination Color Code	
MA3 (Rectangular) One-color Full  	Momentary	Gold	24V AC/DC ±5%	SPDT	MA3L-M1341 *	Specify an illumination color code in place of * in the Part No. A: amber G: green PW: pure white R: red S: blue W: white Y: yellow	
				DPDT	MA3L-M2341 *		
			12V AC/DC ±5%	SPDT	MA3L-M1331 *		
				DPDT	MA3L-M2331 *		
			5V DC ±5%	SPDT	MA3L-M1311 *		
				DPDT	MA3L-M2311 *		
		DPDT	MA3L-M6341 *				
		12V AC/DC ±5%	SPDT	MA3L-M5331 *			
			DPDT	MA3L-M6331 *			
		5V DC ±5%	SPDT	MA3L-M5311 *			
			DPDT	MA3L-M6311 *			
		Maintained	Gold	24V AC/DC ±5%	SPDT		MA3L-A1341 *
	DPDT				MA3L-A2341 *		
	12V AC/DC ±5%			SPDT	MA3L-A1331 *		
				DPDT	MA3L-A2331 *		
	5V DC ±5%			SPDT	MA3L-A1311 *		
				DPDT	MA3L-A2311 *		
	DPDT		MA3L-A6341 *				
	12V AC/DC ±5%		SPDT	MA3L-A5331 *			
			DPDT	MA3L-A6331 *			
	5V DC ±5%		SPDT	MA3L-A5311 *			
			DPDT	MA3L-A6311 *			
	Pilot Light		—	—	24V AC/DC ±5%		—
		12V AC/DC ±5%			—		MA3P-331 *
5V DC ±5%		—			MA3P-311 *		
MA3 (Rectangular) Short Two-way Split  [Standard Color] TOP Marking Side  	Momentary	Gold	24V AC/DC ±5%	SPDT	MA3L-M1343 [*1] [*2]	Specify illumination color codes for left and right sides in place of [*1] and [*2], respectively. G: green PW: pure white R: red W: white Choose the color codes from the standard color arrangement shown below the photo on the left.	
				DPDT	MA3L-M2343 [*1] [*2]		
			12V AC/DC ±5%	SPDT	MA3L-M1333 [*1] [*2]		
				DPDT	MA3L-M2333 [*1] [*2]		
			5V DC ±5%	SPDT	MA3L-M1313 [*1] [*2]		
				DPDT	MA3L-M2313 [*1] [*2]		
		DPDT	MA3L-M6343 [*1] [*2]				
		12V AC/DC ±5%	SPDT	MA3L-M5333 [*1] [*2]			
			DPDT	MA3L-M6333 [*1] [*2]			
		5V DC ±5%	SPDT	MA3L-M5313 [*1] [*2]			
			DPDT	MA3L-M6313 [*1] [*2]			
		Maintained	Gold	24V AC/DC ±5%	SPDT		MA3L-A1343 [*1] [*2]
	DPDT				MA3L-A2343 [*1] [*2]		
	12V AC/DC ±5%			SPDT	MA3L-A1333 [*1] [*2]		
				DPDT	MA3L-A2333 [*1] [*2]		
	5V DC ±5%			SPDT	MA3L-A1313 [*1] [*2]		
				DPDT	MA3L-A2313 [*1] [*2]		
	DPDT		MA3L-A6343 [*1] [*2]				
	12V AC/DC ±5%		SPDT	MA3L-A5333 [*1] [*2]			
			DPDT	MA3L-A6333 [*1] [*2]			
	5V DC ±5%		SPDT	MA3L-A5313 [*1] [*2]			
			DPDT	MA3L-A6313 [*1] [*2]			
	Pilot Light		—	—	24V AC/DC ±5%		—
		12V AC/DC ±5%			—		MA3P-333 [*1] [*2]
5V DC ±5%		—			MA3P-313 [*1] [*2]		

- To mount the horizontal rectangular unit vertically, use the optional vertical leaf spring (MA9Z-T3: 2 pieces). (See page 12 and page 20.)
- For dimensions and terminal arrangement, see page 9. For internal circuit, see page 16.

MA Series Illuminated Pushbuttons / Pilot Lights

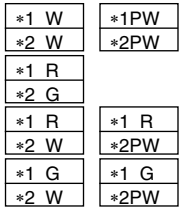
MA3 Illuminated Pushbuttons / Pilot Lights

Package Quantity: 1

Shape	Operation	Contact Material	Operating Voltage	Contact	Part No.	Illumination Color Code	
MA3 (Rectangular) Long Two-way Split  [Standard Color] TOP Marking Side  	Momentary	Gold	24V AC/DC ±5%	SPDT	MA3L-M1342 *1 *2	Specify illumination color codes for left and right sides in place of *1 and *2, respectively. G: green PW: pure white R: red W: white Choose the color codes from the standard color arrangement shown below the photo on the left.	
				DPDT	MA3L-M2342 *1 *2		
			12V AC/DC ±5%	SPDT	MA3L-M1332 *1 *2		
				DPDT	MA3L-M2332 *1 *2		
			5V DC ±5%	SPDT	MA3L-M1312 *1 *2		
				DPDT	MA3L-M2312 *1 *2		
		DPDT	MA3L-M6342 *1 *2				
		12V AC/DC ±5%	SPDT	MA3L-M5332 *1 *2			
			DPDT	MA3L-M6332 *1 *2			
		5V DC ±5%	SPDT	MA3L-M5312 *1 *2			
			DPDT	MA3L-M6312 *1 *2			
		Maintained	Gold	24V AC/DC ±5%	SPDT		MA3L-A1342 *1 *2
	DPDT				MA3L-A2342 *1 *2		
	12V AC/DC ±5%			SPDT	MA3L-A1332 *1 *2		
				DPDT	MA3L-A2332 *1 *2		
	5V DC ±5%			SPDT	MA3L-A1312 *1 *2		
				DPDT	MA3L-A2312 *1 *2		
	DPDT	MA3L-A6342 *1 *2					
12V AC/DC ±5%	SPDT	MA3L-A5332 *1 *2					
	DPDT	MA3L-A6332 *1 *2					
5V DC ±5%	SPDT	MA3L-A5312 *1 *2					
	DPDT	MA3L-A6312 *1 *2					
Pilot Light	—	—	—	MA3P-342 *1 *2			
			—	MA3P-332 *1 *2			
			—	MA3P-312 *1 *2			
MA3 (Rectangular) Two-color Alternate  	Momentary	Gold	24V AC/DC ±5%	SPDT	MA3L-M1344RG	Red (R) ↔ Green (G) alternate illumination	
				DPDT	MA3L-M2344RG		
		Silver	24V AC/DC ±5%	SPDT	MA3L-M5344RG		
				DPDT	MA3L-M6344RG		
	Maintained	Gold	24V AC/DC ±5%	SPDT	MA3L-A1344RG		
				DPDT	MA3L-A2344RG		
		Silver	24V AC/DC ±5%	SPDT	MA3L-A5344RG		
				DPDT	MA3L-A6344RG		
	Pilot Light	—	—	24V AC/DC ±5%	—		MA3P-344RG

• To mount the horizontal rectangular unit vertically, use the optional vertical leaf spring (MA9Z-T3: 2 pieces). (See page 12 and page 20.)

Dimensions

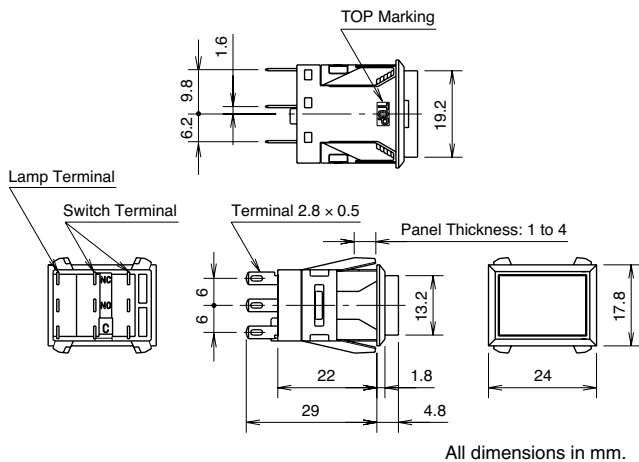

Terminal Arrangement (Bottom View)

For internal circuit, see page 16.
Long Two-way Split Illumination

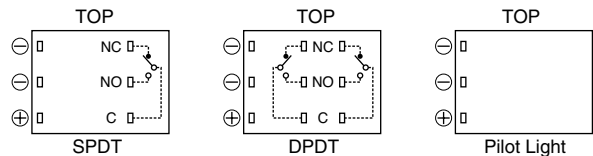

Two-color Alternate Illumination

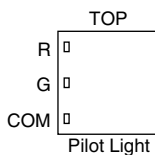

- Two negative (–) terminals are not interconnected inside.
- For “One-color Full” illumination, use the upper negative (–) terminal.
- For division into upper and lower sections, connect the negative (–) terminals for the upper and lower circuits separately.
- The above figure shows the polarities of the 5V DC type. (The 12V AC/DC and 24V AC/DC types have no polarity.)

MA Series Illuminated Pushbuttons / Pilot Lights

MA8 Illuminated Pushbuttons / Pilot Lights

Package Quantity: 1

Shape	Operation	Contact Material	Operating Voltage	Contact	Part No.	Illumination Color Code
MA8 (Round) One-color Full 	Momentary	Gold	24V AC/DC ±5%	SPDT	MA8L-M1141 *	Specify an illumination color code in place of * in the Part No. A: amber G: green PW: pure white R: red S: blue W: white Y: yellow
				DPDT	MA8L-M2141 *	
			12V AC/DC ±5%	SPDT	MA8L-M1131 *	
				DPDT	MA8L-M2131 *	
			5V DC ±5%	SPDT	MA8L-M1111 *	
				DPDT	MA8L-M2111 *	
		Silver	24V AC/DC ±5%	SPDT	MA8L-M5141 *	
				DPDT	MA8L-M6141 *	
			12V AC/DC ±5%	SPDT	MA8L-M5131 *	
				DPDT	MA8L-M6131 *	
			5V DC ±5%	SPDT	MA8L-M5111 *	
				DPDT	MA8L-M6111 *	
	Maintained	Gold	24V AC/DC ±5%	SPDT	MA8L-A1141 *	
				DPDT	MA8L-A2141 *	
			12V AC/DC ±5%	SPDT	MA8L-A1131 *	
				DPDT	MA8L-A2131 *	
			5V DC ±5%	SPDT	MA8L-A1111 *	
				DPDT	MA8L-A2111 *	
		Silver	24V AC/DC ±5%	SPDT	MA8L-A5141 *	
				DPDT	MA8L-A6141 *	
			12V AC/DC ±5%	SPDT	MA8L-A5131 *	
DPDT				MA8L-A6131 *		
5V DC ±5%			SPDT	MA8L-A5111 *		
			DPDT	MA8L-A6111 *		
Pilot Light	—	—	24V AC/DC ±5%	—	MA8P-141 *	
			12V AC/DC ±5%	—	MA8P-131 *	
			5V DC ±5%	—	MA8P-111 *	



Dimensions

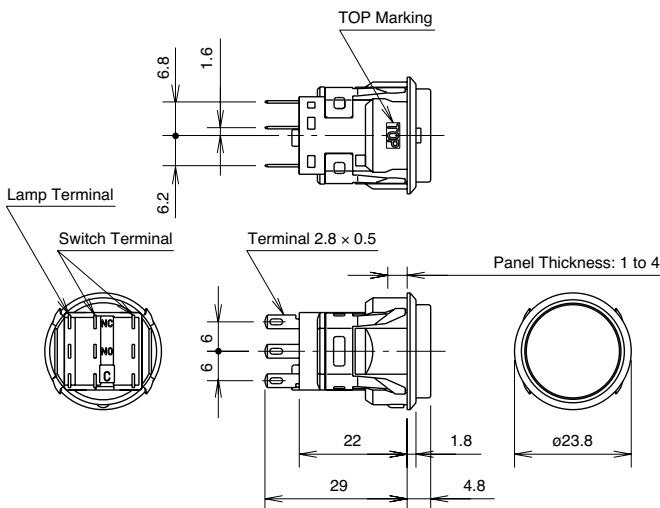

All dimensions in mm.

Terminal Arrangement (Bottom View)



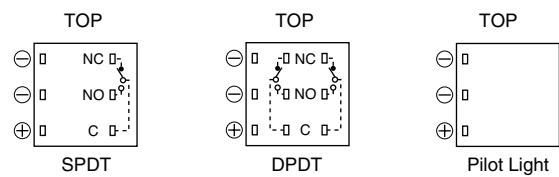



- For internal circuit, see page 16.
- The following figure shows the polarities of the 5V DC type. (The 12V DC and 24V DC types have no polarity.)



MA Series Pushbuttons

MA2/MA3/MA8 Pushbuttons

Package Quantity: 1

Shape	Operation	Contact Material	Contact	Part No.	Button Color Code			
					Button	Lens		
MA2 (Square)  	Momentary	Gold	SPDT	MA2B-M119 *	Specify an opaque button color code in place of * in the Part No.	Specify a transparent lens color code in place of * in the Part No.		
			DPDT	MA2B-M219 *				
		Silver	SPDT	MA2B-M519 *				
			DPDT	MA2B-M619 *				
	Maintained	Gold	SPDT	MA2B-A119 *				
			DPDT	MA2B-A219 *				
		Silver	SPDT	MA2B-A519 *				
			DPDT	MA2B-A619 *				
		MA3 (Rectangular)  	Momentary	Gold	SPDT	MA3B-M139 *	B: black G: green R: red S: blue W: white Y: yellow	LA: amber LG: green LR: red LS: blue LW: white LY: yellow
					DPDT	MA3B-M239 *		
Silver	SPDT			MA3B-M539 *				
	DPDT			MA3B-M639 *				
Maintained	Gold		SPDT	MA3B-A139 *				
			DPDT	MA3B-A239 *				
	Silver		SPDT	MA3B-A539 *				
			DPDT	MA3B-A639 *				
	MA8 (Round) Pushbuttons  		Momentary	Gold	SPDT	MA8B-M119 *		
					DPDT	MA8B-M219 *		
Silver		SPDT		MA8B-M519 *				
		DPDT		MA8B-M619 *				
Maintained		Gold	SPDT	MA8B-A119 *				
			DPDT	MA8B-A219 *				
		Silver	SPDT	MA8B-A519 *				
			DPDT	MA8B-A619 *				

Note: The button is opaque. Color screen and a marking plate are not included. Apply marking directly on the button front surface, if required. Color screen and marking plates are included with lens style buttons.

• To mount the horizontal unit vertically, use the optional vertical leaf spring (MA9Z-T3: 2 pieces). (See page 12 and page 20.)

Dimensions

MA2 (Square)

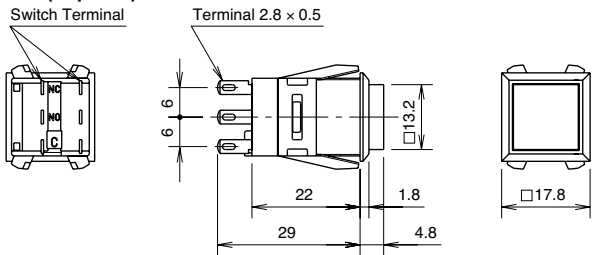

Terminal Arrangement (Bottom View)

For internal circuit, see page 16.

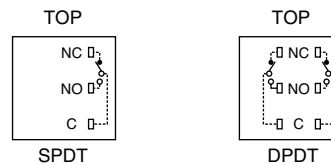

MA3 (Rectangular)

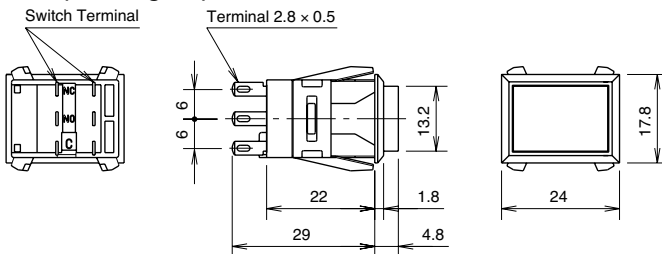



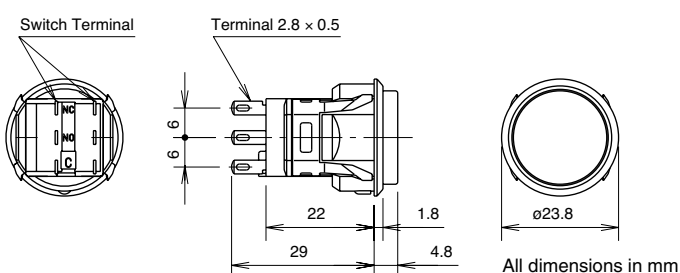



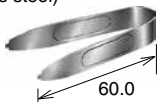

MA8 (Round)



All dimensions in mm.

MA Series Accessories

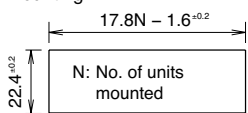
Accessories						
Name & Shape	Specifications	Part No.	Ordering No.	Package Quantity	Remarks	Dimension Page
Lens Removal Tool (Stainless steel) 	—	MT-101	MT-101	1	<ul style="list-style-type: none"> Used to remove the lens from the housing. (Compatible with IDEC's A series Miniature Control Units) 	—
Socket (Polyamide) 	For MA2 Square For MA8 Round For MA3 Rectangular	Solder Terminals MA9Z-C2 PC Board Terminals MA9Z-C2V Solder Terminals MA9Z-C3 PC Board Terminals MA9Z-C3V	MA9Z-C2 MA9Z-C2V MA9Z-C3 MA9Z-C3V	1 1 1 1	<ul style="list-style-type: none"> Snaps onto the rear of MA units. 	13
Barrier (Polycarbonate) 	For MA2 Square For MA3 Rectangular	End Barrier (Black) MA9Z-BF1B Spacer Barrier (Black) MA9Z-BF2B	MA9Z-BF1BPN10 MA9Z-BF2BPN10	10 10	<ul style="list-style-type: none"> Used to prevent inadvertent operation and improve panel appearance. Note: For panel cut-out dimensions, see page 17. 	14
Guard Barrier (Polycarbonate) 	For MA2 Square For MA3 Rectangular	Black MA9Z-G2B Black MA9Z-GF3B	MA9Z-G2BPN10 MA9Z-GF3BPN10	10 10	<ul style="list-style-type: none"> For panel cut-out dimensions, see page 17. Cannot be used in combination with barriers. 	14
Switch Guard (Polycarbonate) 	For MA2 Square For MA3 Rectangular	MA9Z-K2 MA9Z-KF3	MA9Z-K2 MA9Z-KF3	1 1	<ul style="list-style-type: none"> 180° opening spring return type Note: For panel cut-out dimensions, see page 18. Cannot be used in combination with barriers. 	13
Switch Guard with Lens (Polycarbonate) 	For MA3 Rectangular	MA9Z-KR3	MA9Z-KR3	1	<ul style="list-style-type: none"> Not compatible with Maintained. For mounting procedure, see Mounting/Removing the Lens and Marking Plate on page 19. Cannot be used in combination with barriers. 	13
Dust Cover (Base: Polypropylene, Cover: Vinyl chloride elastomer) 	For MA2 Square For MA3 Rectangular	MA9Z-D2 MA9Z-D3	MA9Z-D2 MA9Z-D3	1 1	<ul style="list-style-type: none"> Non-waterproof type For panel cut-out dimensions, see page 18. 	14
Dummy Unit (Polycarbonate) 	For MA2 Square For MA3 Rectangular	MA9Z-E2B MA9Z-E3FB	MA9Z-E2B MA9Z-E3FB	1 1	<ul style="list-style-type: none"> Housing color: Black 	14
MA3 Vertical Leaf Spring (Stainless steel) 	Panel cut-out of vertical mounting 	MA9Z-T3	MA9Z-T3PN10	10	<ul style="list-style-type: none"> By using the optional vertical leaf springs, MA3 can be vertically mounted in a horizontal row. For the mounting and removing procedures, see page 20. 	—

Accessory Dimensions

Socket

For MA2 Square
For MA8 Round

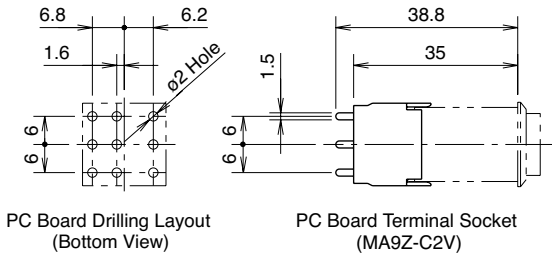
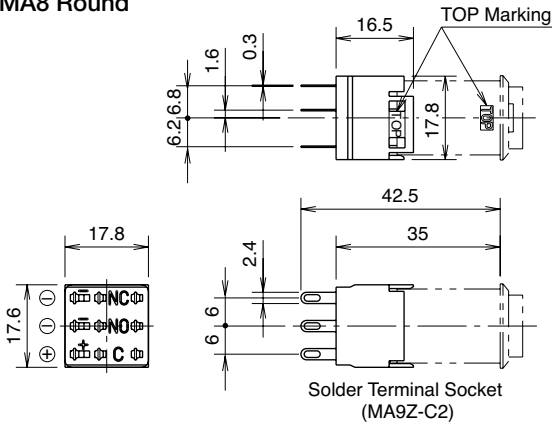

For MA3 Rectangular

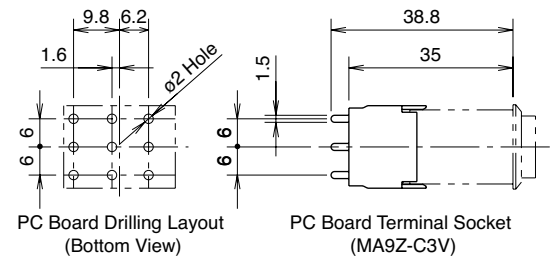
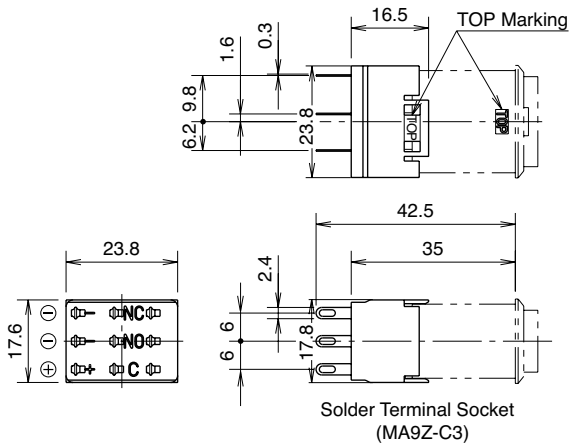

Switch Guard

For MA2 Square (MA9Z-K2)

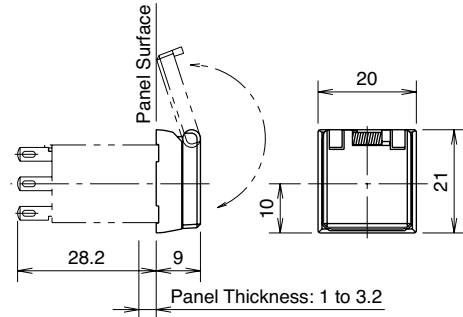

For MA3 Rectangular (MA9Z-KF3)

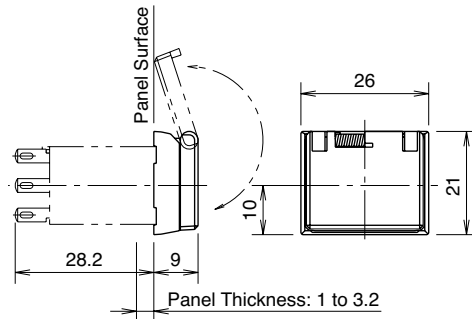

Note: For panel cut-out dimensions, see page 18.

Switch Guard with Lens

For MA3 Rectangular (MA9Z-KR3)

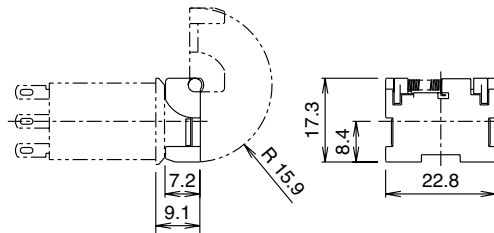

Note: The panel cut-out dimensions for the switch guard with lens are the same as those for the MA3 rectangular type.

All dimensions in mm.

MA Series Accessories

Accessory Dimensions

Guard Barrier

For MA2 Square (MA9Z-G2B)

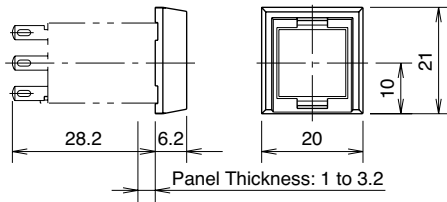

For MA3 Rectangular (MA9Z-GF3B)

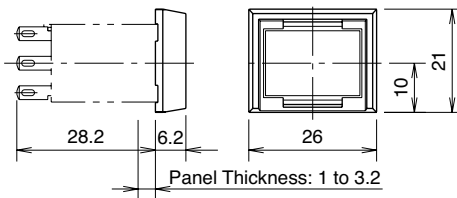

Note: For panel cut-out dimensions, see page 17.

Barrier

For MA2 Square
For MA3 Rectangular

End Barrier (MA9Z-BF1B)

Spacer Barrier (MA9Z-BF2B)

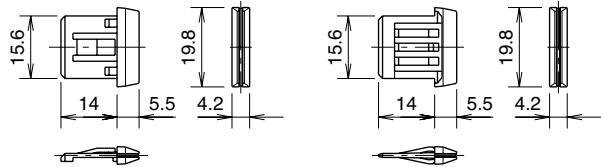

Note: For installation of the unit, see the panel cut-out dimensions on page 17.

Dummy Unit

For MA2 Square (MA9Z-E2B)

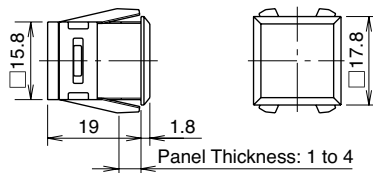

Note: For panel cut-out dimensions, see page 17 (same as guard barrier MA2 Square).

For MA3 Rectangular (MA9Z-E3FB)

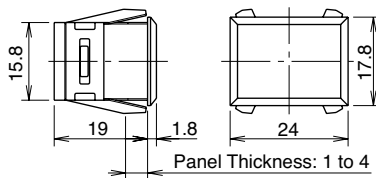

Note: For panel cut-out dimensions, see page 17 (same as guard barrier MA3 Rectangular).

Dust Cover

For MA2 Square (MA9Z-D2)

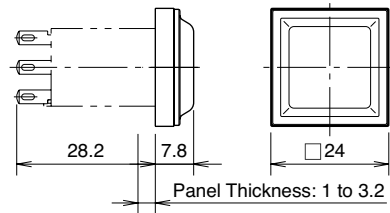

For MA3 Rectangular (MA9Z-D3)

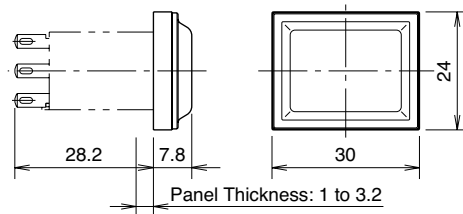





Note: For panel cut-out dimensions, see page 18.

All dimensions in mm.

MA Series Maintenance Parts

Maintenance Parts

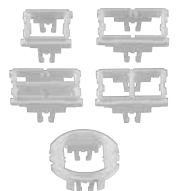
Name & Shape	Specifications		Part No.	Ordering No.	Package Quantity	Remarks
Color Screen (Acrylic) 	For MA2 Square	Full (11.5H × 11.5W × 1.1t)	MA9Z-P21 *	MA9Z-P21 * PN05	5	<ul style="list-style-type: none"> Specify a color code in place of * in the Ordering No. A (Amber), C (Clear), R (Red), S (Blue)
	For MA3 Rectangular	Full (11.5H × 17.5W × 1.1t)	MA9Z-P31 *	MA9Z-P31 * PN05	5	
		Long Two-way Split (5.7H × 17.5W × 1.1t)	MA9Z-P32 *	MA9Z-P32 * PN05	5	<ul style="list-style-type: none"> Only C (Clear), G (Green), and R (Red) are available.
		Short Two-way Split (11.5H × 8.7W × 1.1t)	MA9Z-P33 *	MA9Z-P33 * PN05	5	
	For MA8 Round	Full (ϕ 17.2 × 1.1t)	MA9Z-P81 *	MA9Z-P81 * PN05	5	<ul style="list-style-type: none"> A (Amber), C (Clear), G (Green), R (Red), S (Blue), Y (Yellow)
Marking Plate (Acrylic) 	For MA2 Square	11.5H × 11.5W × 1.1t	MA9Z-P21W	MA9Z-P21WPN05	5	<ul style="list-style-type: none"> No difference between both sides of the marking plate.
	For MA3 Rectangular	11.5H × 17.5W × 1.1t	MA9Z-P31W	MA9Z-P31WPN05	5	
	For MA8 Round	ϕ 17.2 × 1.1t	MA9Z-P81W	MA9Z-P81WPN05	5	
Lens (Polycarbonate) 	For MA2 Square		MA9Z-L2	MA9Z-L2PN05	5	<ul style="list-style-type: none"> The lens is transparent.
	For MA3 Rectangular		MA9Z-L3	MA9Z-L3PN05	5	
	For MA8 Round		MA9Z-L8	MA9Z-L8PN05	5	
Button (Polyarylate) 	For MA2 Square		MA9Z-B2 *	MA9Z-B2 * PN05	5	<ul style="list-style-type: none"> Specify a color code in place of * in the Ordering No. B (Black), G (Green), R (Red), S (Blue), W (White), Y (Yellow)
	For MA3 Rectangular		MA9Z-B3 *	MA9Z-B3 * PN05	5	
	For MA8 Round		MA9Z-B8 *	MA9Z-B8 * PN05	5	
Lens Holder (Polyarylate) 	For MA2 Square	Full	MA9Z-LH21	MA9Z-LH21PN05	5	
	For MA3 Rectangular	Full	MA9Z-LH31	MA9Z-LH31PN05	5	
		Long Two-way Split (with light barrier)	MA9Z-LH32	MA9Z-LH32PN05	5	
		Short Two-way Split (with light barrier)	MA9Z-LH33	MA9Z-LH33PN05	5	
	For MA8 Round	Full	MA9Z-LH81	MA9Z-LH81PN05	5	

Maintenance Parts (LED Unit)

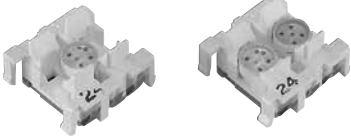
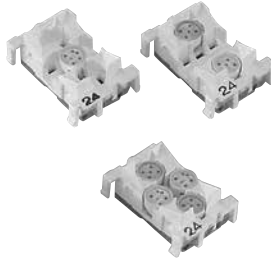
Name & Shape	Specifications	Operational Voltage	Part No.	Remarks	
MA2 Square / MA8 Round 	One-color	24V AC/DC \pm 5%	MA9Z-2D41N- *	<ul style="list-style-type: none"> Specify a color code in place of * in the Ordering No. A (Amber), G (Green), PW (Pure White), R (Red), S (Blue), W (White) Use a PW (pure white) LED unit for yellow illumination. 	
		12V AC/DC \pm 5%	MA9Z-2D31N- *		
		5V DC \pm 5%	MA9Z-2D11N- *		
MA3 Rectangular 	Two-color Alternate (Except for MA8)	24V AC/DC \pm 5%	MA9Z-2D44N-RG	<ul style="list-style-type: none"> Blue (S) is for One-color only. For color codes of Two-way Split type, WW, RG, RW and GW are available. Package quantity: 1 	
		One-color	24V AC/DC \pm 5%		MA9Z-3D41N- *
			12V AC/DC \pm 5%		MA9Z-3D31N- *
	5V DC \pm 5%		MA9Z-3D11N- *		
	Short Two-way Split	24V AC/DC \pm 5%	MA9Z-3D43N- **		
		12V AC/DC \pm 5%	MA9Z-3D33N- **		
		5V DC \pm 5%	MA9Z-3D13N- **		
	Long Two-way Split	24V AC/DC \pm 5%	MA9Z-3D42N- **		
		12V AC/DC \pm 5%	MA9Z-3D32N- **		
5V DC \pm 5%		MA9Z-3D12N- **			
Two-color Alternate	24V AC/DC \pm 5%	MA9Z-3D44N-RG			

MA Series Internal Circuit

Internal Circuit

MA2 (Square) / MA8 (Round)

MA2 (Square) MA8 (Round)	One-color	5V DC 	12V AC/DC · 24V AC/DC
	Two-color Alternate (MA2)	24V AC/DC 	

Note: (A), (B): LED modules (For details of the LED modules, see the LED module internal circuit below.)

MA3 (Rectangular)

MA3 (Rectangular)	One-color	5V DC 	12V AC/DC
		24V AC/DC 	
	Short Two-way Split	5V DC 	12V AC/DC · 24V AC/DC
		24V AC/DC 	
Long Two-way Split	5V DC 	12V AC/DC · 24V AC/DC 	
	24V AC/DC 		
Two-color Alternate	24V AC/DC 		

Note: (A), (B): LED modules (For details of the LED modules, see the LED module internal circuit below.)

LED Module Internal Circuit

(A)	(B)

MA Series Panel Cut-Out

Panel Cut-out

Item	Front View (mm)	Panel Cut-out Dimensions (mm)	Remarks	
MA2 Square			<p>N: No. of MA units mounted</p> <p>MA2 collective mounting Vertical: 4 rows max. Horizontal: 12 columns max.</p> <p>MA3 collective mounting Vertical: 4 rows max. Horizontal: 9 columns max.</p>	
MA3 Rectangular			<p>* Consider the strength of panel thickness. Panel thickness: 1 to 4 mm</p>	
MA8 Round				
With Barrier	MA2 Square			<p>N: No. of MA units mounted</p> <p>MA2 collective mounting Vertical: 4 rows max. Horizontal: 12 columns max.</p> <p>MA3 collective mounting Vertical: 4 rows max. Horizontal: 9 columns max.</p>
	MA3 Rectangular			<p>* Consider the strength of panel thickness. Panel thickness: 1 to 4 mm</p> <p>Note: When the barrier is mounted, the guard barrier, switch guard or dust cover cannot be mounted together.</p>
With Guard Barrier	MA2 Square			<p>N: No. of MA units mounted</p> <p>MA2 collective mounting Vertical: 4 rows max. Horizontal: 12 columns max.</p> <p>MA3 collective mounting Vertical: 4 rows max. Horizontal: 9 columns max.</p>
	MA3 Rectangular			<p>* Consider the strength of panel thickness. Panel thickness: 1 to 3.2 mm</p> <p>• The panel cut-out are the same as those required for switch guard. Therefore, the guard barrier and switch guard can be used together for collective mounting.</p>

MA Series Panel Cut-Out

Panel Cut-out			
Item	Front View (mm)	Panel Cut-out Dimensions (mm)	Remarks
With Switch Guard	MA2 Square 		N: No. of MA units mounted MA2 collective mounting Vertical: 4 rows max. Horizontal: 12 columns max. MA3 collective mounting Vertical: 4 rows max. Horizontal: 9 columns max.
	MA3 Rectangular 		<ul style="list-style-type: none"> * Consider the strength of panel thickness. Panel thickness: 1 to 3.2 mm • The panel cut-out are the same as those required for guard barrier. Therefore, the switch guard and guard barrier can be used together for collective mounting.
With Dust Cover	MA2 Square 		N: No. of MA units mounted MA2 collective mounting Vertical: 4 rows max. Horizontal: 12 columns max. MA3 collective mounting Vertical: 4 rows max. Horizontal: 9 columns max.
	MA3 Rectangular 		<ul style="list-style-type: none"> * Consider the strength of panel thickness. Panel thickness: 1 to 3.2 mm

Safety Precautions

- Turn off power to the MA unit before installation, removal, wiring, maintenance, and inspection. Failure to turn power off may cause electrical shocks or fire hazard.
- When replacing LED units, use the optional lens removal tool (MT-101) to prevent burning your hand.
- Use the MA unit within the rated values, otherwise electrical shocks or fire hazard may occur.
- For wiring, use wires of proper size to meet the voltage and current requirements.
- Improper soldering or failure to tighten the terminal screw may cause overheating and fire.
- Use the optional locking ring wrench to mount the unit onto a panel.

Instructions

Mounting/Removal of the Lens and Marking Plate

Removal

Pull out the lens unit (lens, color screen, marking plate and lens holder) while pinching the recesses of the lens using the lens removal tool. (See photo 1)
The marking plate can be removed by unlatching the lens from the lens holder. (See photo 2)

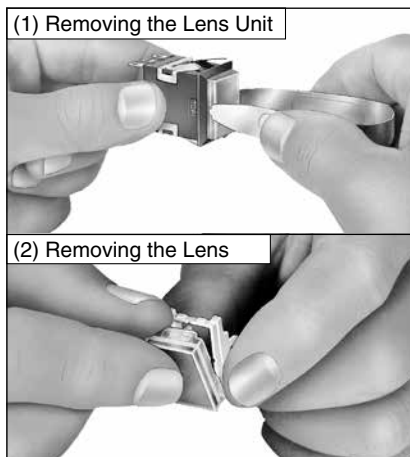
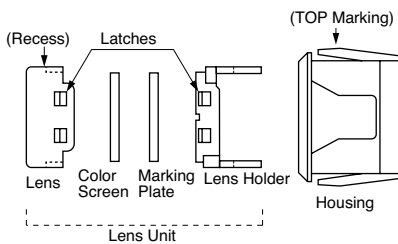

Installation

Put the color screen and marking plate into the lens, then press the lens holder into the lens. Make sure to install the lens unit into the housing in the correct direction.

Mounting Order of Color Screen and Marking Plate

Insert the color screen and the marking plate in the following order, depending on the application.

Display Color (Lamp OFF)	Insertion Order
Color [Initial condition]	A Lens ↓ Color Screen ↓ Marking Plate ↓ Housing
White	B Lens ↓ Marking Plate ↓ Color Screen ↓ Housing

Notes:

1. For white illumination, the display color in OFF status is white, regardless of the mounting order of A or B.
2. Both marking plate and color screen can be engraved.
3. The Two-color Alternate (Red ↔ Green) illumination type uses two marking plates, without using a color screen.

LED Unit

Mounting/Removal of the LED Unit

Remove the LED unit from the housing using the lens removal tool.
To mount the LED unit, insert the LED unit into the housing first, and then insert the lens unit into the housing. In this step, be careful about orientation of each unit. When inserting the LED unit, align the TOP marking on the LED unit with the TOP marking on the housing. Inserting the LED unit in an incorrect orientation may cause damage to the contacts on the LED unit.

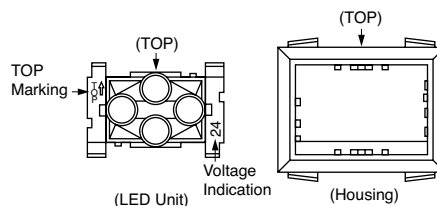

When handling the LED unit for the Long Two-way Split type using G (green) LED or of the Two-color (red/green) Alternate

illumination type, be careful not to touch the metal frame cut part of the LED unit with your hand (see the figure below) to prevent application of static electricity to this part. If static electricity is applied to this part, the LED element may be damaged.

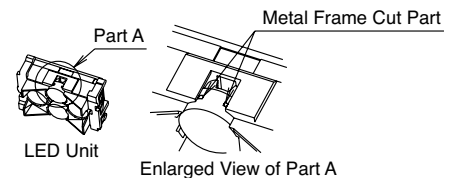

A protective seal is attached to spare LED units to prevent static electricity from being applied to the metal frame cut part. Remove the protective seal immediately before replacing LED units.

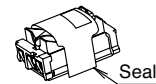

LED Unit Voltage Marking

When mounting or removing the LED unit, make sure that the operational voltage is correct. The operational voltage is indicated by a number on the LED unit, and identified by color of the contact base as follows:

Voltage Indication		LED Unit Operational Voltage
Number	Base Color	
5	Blue	5V DC
12	Yellow	12V AC/DC
14	Red	24V AC/DC

Installation of Accessories

Installing the Barrier

Single mounting

Put end barriers on both sides of the MA unit, insert it from the front of the panel.



MA Series Instructions

Instructions

Collective mounting

Insert end barriers at both ends of MA units, insert them into the panel cut-out. After mounting the MA units into the panel, insert the spacer barrier between the MA units.

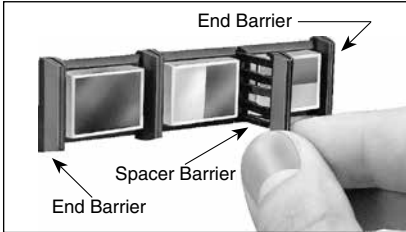

Installing the Switch Guard

Install the switch guard before mounting into a panel cut-out. To install switch guard, place the hinge of the switch guard upward, and depress the switch guard onto the flange of the MA unit.

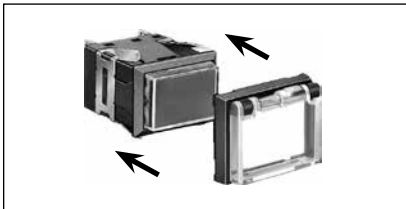

Installing the Socket

Align the TOP marking of the MA unit with that of the socket, and press the socket onto the MA unit.

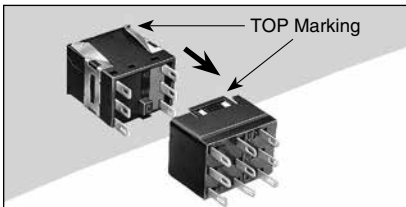

Installation of the Guard Barrier

Install the guard barrier before mounting into a panel cut-out. To install the guard barrier, orientate the notch of guard barrier downward, and depress the guard barrier onto the bezel of the MA unit.

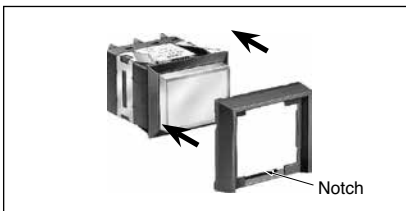

Installation of the Dustproof Cover

Separate the cap (translucent rubber) and the base (black plastic). (See Photo 1) Install the base from the MA unit terminal side onto the bezel. (See Photo 2) In this step, make sure that the base is placed between the bezel and the leaf springs. Then, mount the MA unit into the panel cut-out, and mount the cap onto the base. Make sure that the cap is fitted to the base.

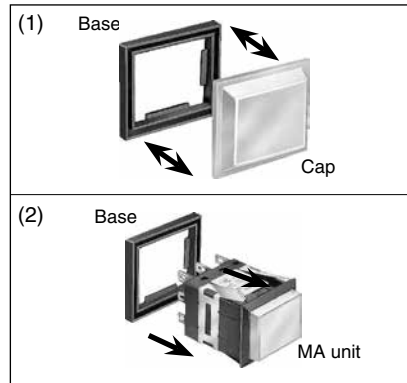

Installation of Leaf Springs for Vertical Mounting

First, insert a small flat-blade screwdriver under the leaf spring on the MA unit, and remove the leaf spring for horizontal mounting.

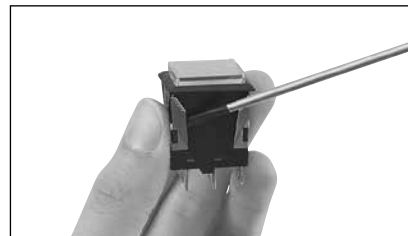

Place the vertical leaf spring on the MA unit temporarily, and then press the spring until it is secured on the MA unit.



Wiring Precautions

- Solder the terminals at 350°C within 3 seconds, using a 60W soldering iron. Sn-Ag-Cu solder is recommended. While soldering, keep the soldering iron as far from the plastic part of the switch as possible. Do not apply external force to the switch unit. Do not bend the terminals, pull the cable, etc. To use a soldering iron, check your actual operating conditions.
- Use a non-corrosive, liquid rosin soldering flux.
- Among the LED terminals, the center terminal on a one-color full illuminated unit is a dummy.
- A current limiting resistor is incorporated in all LED units.

Operating Instructions

LED Operating Voltage (5V DC)

The rated operating voltage is based on a pure direct current source. To use the LED under rectified DC, make sure that the peak voltage does not exceed the rated DC operating voltage. If the peak voltage exceeds the rated DC operating voltage, the LED life may be shortened.

Microswitch Contacts

When using both the NO and NC contacts of the same microswitch, avoid connections of different voltages, or connections of different power supply types. Failure to observe this instruction may cause a short-circuit.

Operating and Storage Conditions

Use the MA unit in an environment within the rated operating temperature and humidity range. Do not use the MA unit in a place where it is subjected to oil or water splashes, or in a place with dust accumulation.

New Super Bright LED Units

To accommodate the new super bright LED unit, the MA2 unit has no protrusion inside. If your MA unit has a protrusion inside, it is an older type and the new LED unit cannot be used. If the new LED unit is used with the old MA unit, the LED may fail to light.

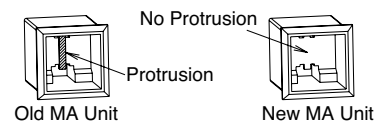

MA Series Combination Control Units

**Save labor and cost for installation [Custom-made]
Choose any MA Series (MA2/MA3) Control Units**

IDEC's MA series Miniature Control Units can be combined in a frame and supplied as a complete assembly.

- Combination type with several MA series units mounted in a frame
- Maximum number of units mounted: 4 rows x 12 columns (MA2)
- Small size (unibody: 22 mm behind the panel) and space-saving
- Super bright LED

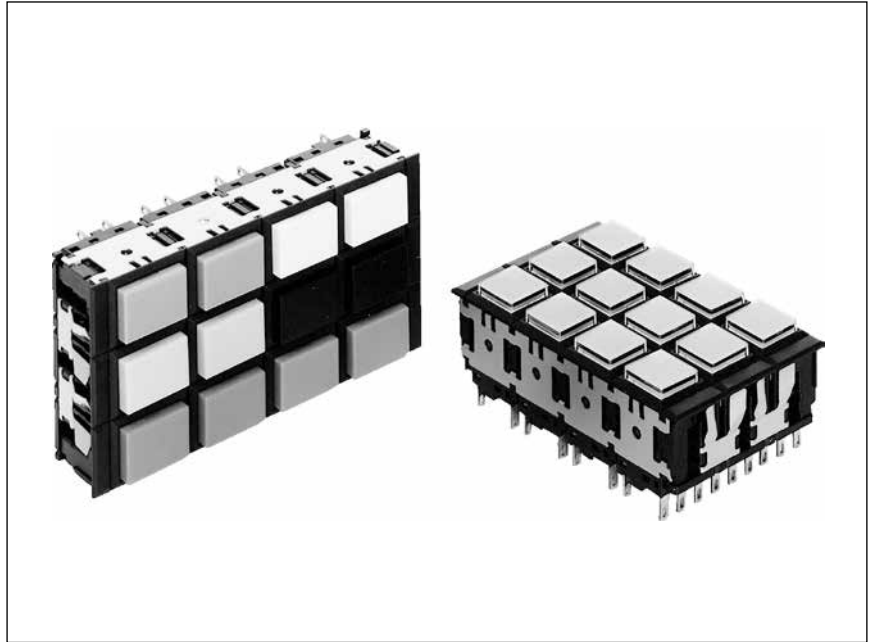

Specifications

Applicable MA Series Units (Note)	MA2/MA3 illuminated pushbuttons and pushbuttons (All models)
Maximum No. of Units Mounted	MA2: 4 rows x 12 columns MA3: 4 rows x 9 columns Mounting in only one row, and mixture of MA2 and MA3 units are not available.
Panel Thickness	1.0 to 4.0 mm
Frame Material	Stainless steel
Operating Temperature	-25 to +55°C (no freezing)
Storage Temperature	-40 to +80°C (no freezing)

Note: For details of the MA series control units, see the preceding pages.

Mounting Clip

Mounting clips are used to secure the MA series combination control units to the rear of the panel. The mounting clips are supplied with the MA units.

Mounting Positions and Quantities of Mounting Clips

No. of Rows	No. of Mounting Clips	Mounting Positions
2	2	
3	4	
4	4	

Note: The screw tightening torque for the mounting clips should be 0.39 N·m maximum.

Mounting Procedure

To mount the MA series units into a panel cut-out, insert the assembly from the front of the panel first, and then fit the mounting clips into the mounting grooves from the rear of the panel. Then, tighten the screws as shown below. After tightening the screws, apply loctite to the screws.

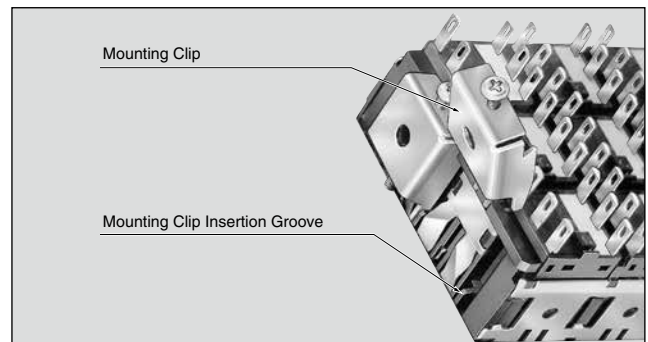

Note: Insert the mounting clip into the groove up to the nail.

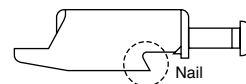

The mounting clip is supplied with the housing.

Terminal Arrangement (Bottom View)

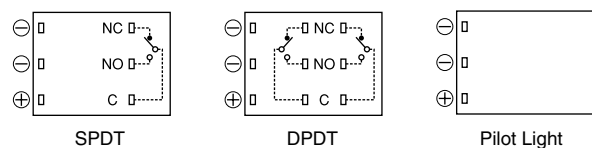

MA Series Combination Control Units

Dimensions

Combination of MA2 Units (Square)

All dimensions in mm.

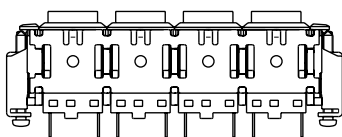
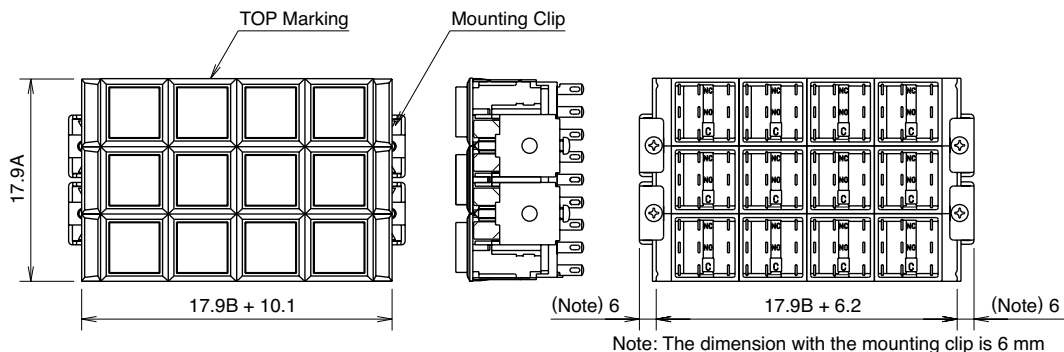

A: Rows
B: Columns

Panel Cut-out (Panel Thickness: 1.0 to 4.0)

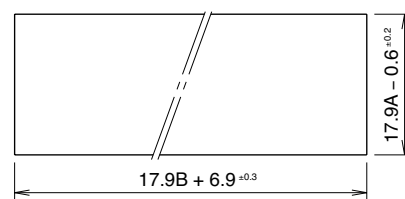

Combination of MA3 Units (Rectangular)

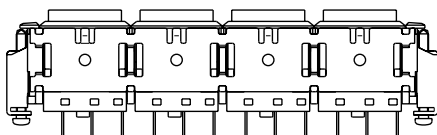
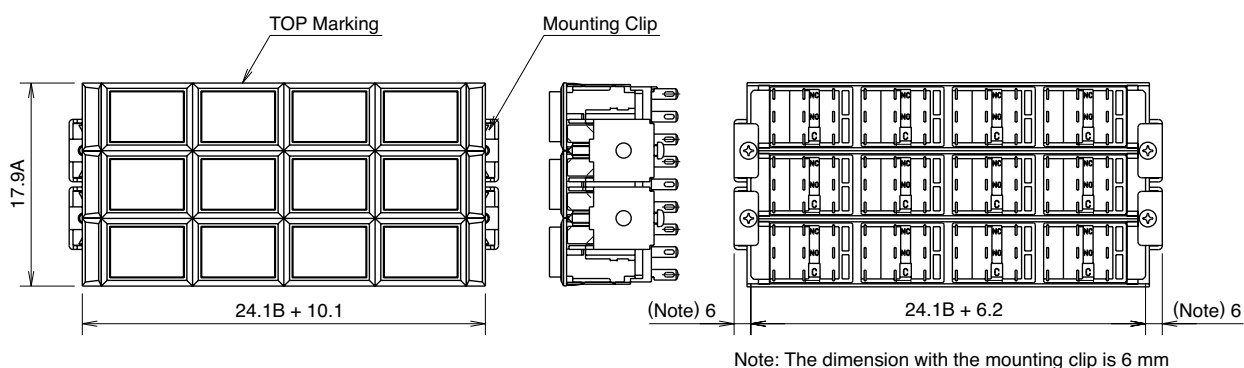

A: Rows
B: Columns

Panel Cut-out (Panel Thickness: 1.0 to 4.0)

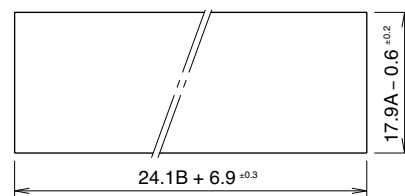

Instructions

Lens and marking plate mounting/removing procedures, LED unit handling precaution, and wiring precaution are the same as those of the single mounting of the MA series miniature control unit. For details, see page 19 and page 20.

Ordering Information

Contact IDEC for information on the ordering method, price and delivery.

MC Series Illuminated Control Units

Super bright LED lamp **or incandescent lamp** illumination

Rectangular and square body control units

• Compatible with both LED and incandescent lamps.

- Super LED improves visibility and saves energy.
- Removable contact blocks promote easy PC board mounting.
- Snap-action switching contacts.
- Slow-action and maintained types are also available.
- The solder terminal accepts quick connect receptacles enhancing safety and enabling easy wiring.
- Illumination face division: Full to 4-way split (MC3D) or 2-way split (MC2D)
- Lens and color screens can be changed easily without the need for removal of power, because contacts are not operated when the lens is first inserted into the housing.
- UL and c-UL recognized, EN compliant



Applicable Standards	Mark	File No. or Organization
UL508 CSA C22.2 No.14		UL File No. E55996
EN60947-1 EN60947-5-1		TÜV Rheinland J9550803
EN60947-1 EN60947-1		EU Low Voltage Directive
GB14048.5		CCC2006010305180952 (MC2D) 2006010305180954 (MC3D) (except pilot lights)

MC Series

Item	MC3D (Rectangular)		MC2D (Square)
	Horizontal Barrier	Horizontal Flange	Flange
Illumination Face Size	18.8 × 26.6 mm		18.8 × 18.8 mm
Face Division	LED: Full to 4-way split Incandescent: Full only		LED: Full or horizontal 2-way split Incandescent: Full only
No. of Lamps	Full illumination: 2 (LED or incandescent) Vertical 2-way split: 2 (LED) Horizontal 2-way, 3-way, 4-way split: 4 (LED)		Full: 1 (LED or incandescent) Horizontal 2-way split: 2 (LED)
Illumination Color	Amber, Green, Pure White, Red, Blue, White, Yellow		
Contact Material	Silver or gold contact microswitch		
No. of Contacts	SPDT, DPDT, 3PDT		SPDT, DPDT
Operation	Momentary (snap action or slow action), maintained, pilot light		
Terminal Style	Solder tab terminal #110 (compatible with quick connect receptacles), PC board terminal		
Housing Color	Black, gray		

Specifications

Operating Temperature	-25 to +40°C (no freezing)
Storage Temperature	-30 to +60°C (no freezing)
Operating Humidity	35 to 90% RH (no condensation)
Insulation Resistance	Between live and dead metal parts: 100 MΩ (500V DC megger) Between terminals of different poles: 100 MΩ (500V DC megger)
Dielectric Strength	Between live and dead metal parts: 2000V, 1 minute Between live parts of different poles: 2000V, 1 minute Between terminals of the same pole: 1000V, 1 minute
Contact Resistance	50 mΩ maximum (initial value)
Vibration Resistance	Operating extremes: 5 to 55 Hz, amplitude 0.5 mm Damage limits: 5 to 55 Hz, amplitude 0.5 mm (2 hours each in 3 axes)
Shock Resistance	Operating extremes: 200 m/s ² Damage limits: 500 m/s ²
Mechanical Life	Momentary: 1,000,000 operations minimum Maintained: 250,000 operations minimum Slow action: 1,000,000 operations minimum
Electrical Life	50,000 operations minimum (rated operating current: specification 1) 100,000 operations minimum (rated operating current: specification 2) * 50,000 operations minimum when using silver contacts at 125V/5A resistance load (UL rating)
Operating Frequency	Momentary: 1,800 operations/hour Maintained: 900 operations/hour Slow action: 1,800 operations/hour
Degree of Protection	IP40 (operator) (IEC 60529)

Contact Ratings

Silver Contact (switch base: gray)

Rated Insulation Voltage			250V			
Rated Operating Voltage			30V	125V	250V	
Rated Operating Current	Specifi- cation 1*	AC 50/60Hz	Resistive load	—	5A	5A
		Inductive load	—	3A	1.5A	
	DC	Resistive load	5A	1.1A	—	
		Inductive load	2.5A	0.55A	—	
Specifi- cation 2*	AC 50/60Hz	Resistive load	—	5A	3A	
		Inductive load	—	3A	1.5A	
	DC	Resistive load	3A	0.6A	—	
		Inductive load	1A	0.22A	—	
Rated Thermal Current			5A			
Contact Material			Silver			

* AC inductive load: PF=0.6 to 0.7 DC inductive load: L/R=7 ms max.
* See Specifications for electrical life.

Gold Contact (Switch Base: Blue)

Rated Insulation Voltage		250V	
Rated Operating Voltage		30V DC	125V AC
Rated Operating Current (resistive load)		0.1A	0.1A
Rated Thermal Current		3A	
Contact Material		Gold-clad silver cross-bar contact	

Minimum applicable load (reference value): 5V AC/DC, 1 mA

MC Series Illuminated Control Units

LED / Incandescent Lamps

LFTD LED Lamp

Part No.	LFTD-5*	LFTD-6*	LFTD-1*	LFTD-2*
Lamp Base	SX6S/8x5.4			
Operating Voltage	5V DC±5%	6V AC/DC±10%	12V AC/DC±10%	24V AC/DC±10%
Rated Voltage	5V DC	6V AC/DC	12V AC/DC	24V AC/DC
Current Draw	A, G, PW, R, S, W	A, R, W	G, PW, S	A, G, PW, R, S, W
	AC	9 mA	10 mA	9 mA
DC	8 mA	7 mA	7 mA	8 mA
Lamp Base Color	Same as illumination color			
Voltage Marking	Die stamped on the lamp base			
Life (reference value)	Approx. 50,000 hours (When used on complete DC, the luminance is reduced to 50% of the initial intensity.)			
Internal Circuit				

- Specify a color code in place of * in the Part No. A (amber), G (green), PW (pure white), R (red), S (blue), W (white)
Use a PW (pure white) LED lamp for yellow illumination.
- Required Quantity of LED Lamps
MC3D — Full and horizontal 2-way split: 2 lamps; Horizontal 2-way, 3-way, and 4-way split: 4 lamps
MC2D — Full: 1 lamp; Horizontal 2-way split: 2 lamps

LH Incandescent Lamp (0.5W)

Part No.	LH-06	LH-14	LH-28
Lamp Base	SX6S/8x5.4		
Operating Voltage	5V AC/DC	12V AC/DC	24V AC/DC
Rated Voltage	6V AC/DC	14V AC/DC	28V AC/DC
Rated Current	0.1A	0.05A	0.025A
Life (reference value)	Approx. 2,000 hours (average at the rated value)		

- Required Quantity of Incandescent Lamps
MC3D — Full: 2 lamps
MC2D — Full: 1 lamp

Illumination Faces for LED and Incandescent Lamps

Series	Face Type	LED	Incandescent
MC3	A, C	2	2
	B, D, E, F	4	—
MC2	A	1	1
	B	2	—

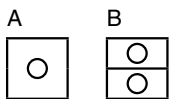
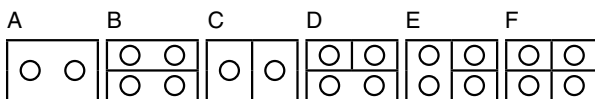

Face Division

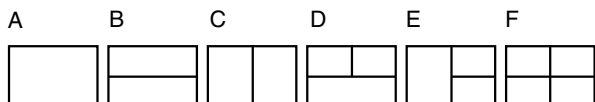

MC3

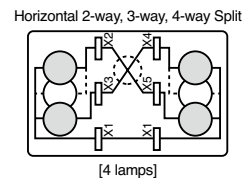
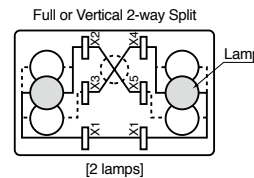

MC2

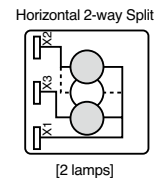
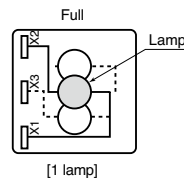

MC Series Illuminated Control Units

Illumination Unit Structure

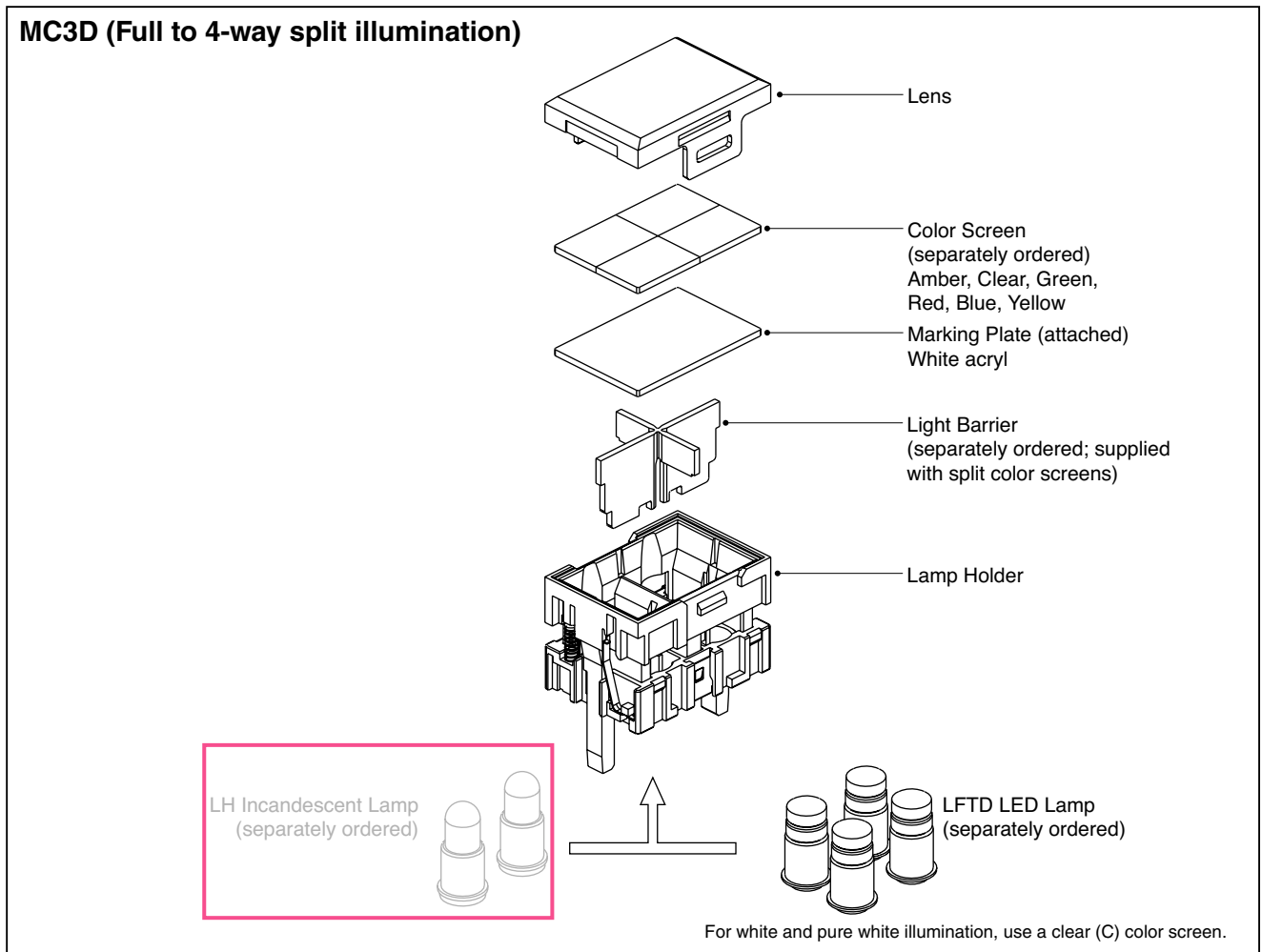

Illumination Face Division & Illumination Color

Used For	MC3D						MC2D	
Part No.	MC9Z-PA3*PN05	MC9Z-3DB	MC9Z-3DC	MC9Z-3DD	MC9Z-3DE	MC9Z-3DF	MC9Z-PA2*PN05	MC9Z-2DB
Face Division								
Illumination Color and Size		 	 	 	 	 		
	*: Color Code	Light Barrier	Light Barrier	Light Barrier	Light Barrier	Light Barrier	*: Color Code	Light Barrier
Quantity	Same color 5 pcs/set	6 pcs/set	6 pcs/set	12 pcs/set	12 pcs/set	12 pcs/set	Same color 5 pcs/set	6 pcs/set

* Color Code: A (amber), C (clear), GD (green for LED), **GL (green for incandescent)**, R (red), S (blue), Y (yellow)

* Use clear (C) color screen for white and pure white illumination.

MC Series Illuminated Pushbuttons / Pilot Lights

MC3D-**0R (Rectangular Horizontal / Barrier)

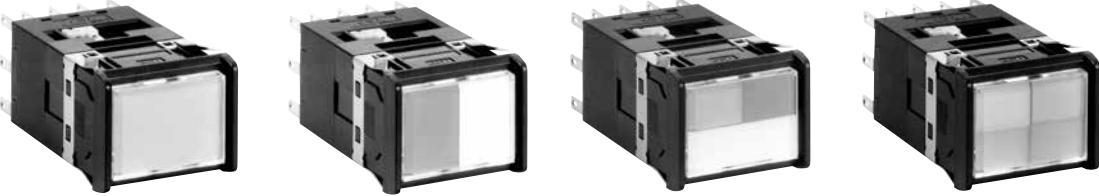

(except pilot light)

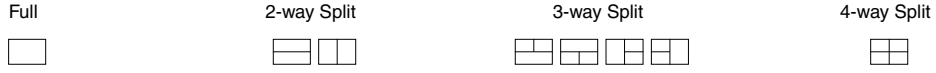

Package Quantity: 1

Operation	Contact	Part No.				Marking Plate	Color Screen	Light Source		
		Solder/Tab Terminal		PC Board Terminal						
		Housing Color: Black	Housing Color: Gray	Housing Color: Black	Housing Color: Gray					
Momentary (Snap Action)	Silver	SPDT	MC3D-M10RB	MC3D-M10RN	—	—	White Size: 24.8 x 17 x 1 mm Material: Acrylic	Applicable LED Lamp 24V AC/DC: LFTD-2* 12V AC/DC: LFTD-1* 6V AC/DC: LFTD-6* 5V DC: LFTD-5*		
		DPDT	MC3D-M20RB	MC3D-M20RN	—	—				
		3PDT	MC3D-M30RB	MC3D-M30RN	—	—				
	Gold	SPDT	MC3D-M50RB	MC3D-M50RN	MC3D-M50VRB	MC3D-M50VRN				
		DPDT	MC3D-M60RB	MC3D-M60RN	MC3D-M60VRB	MC3D-M60VRN				
		3PDT	MC3D-M70RB	MC3D-M70RN	MC3D-M70VRB	MC3D-M70VRN				
Momentary (Slow Action)	Silver	SPDT	MC3D-S10RB	MC3D-S10RN	—	—			Material: Acrylic	Applicable Incandescent Lamp 28V: LH-28 14V: LH-14 6V: LH-06
		DPDT	MC3D-S20RB	MC3D-S20RN	—	—				
		3PDT	MC3D-S30RB	MC3D-S30RN	—	—				
	Gold	SPDT	MC3D-S50RB	MC3D-S50RN	MC3D-S50VRB	MC3D-S50VRN				
		DPDT	MC3D-S60RB	MC3D-S60RN	MC3D-S60VRB	MC3D-S60VRN				
		3PDT	MC3D-S70RB	MC3D-S70RN	MC3D-S70VRB	MC3D-S70VRN				
Maintained	Silver	SPDT	MC3D-A10RB	MC3D-A10RN	—	—	Supplied	Order Separately		
		DPDT	MC3D-A20RB	MC3D-A20RN	—	—				
		3PDT	MC3D-A30RB	MC3D-A30RN	—	—				
	Gold	SPDT	MC3D-A50RB	MC3D-A50RN	MC3D-A50VRB	MC3D-A50VRN				
		DPDT	MC3D-A60RB	MC3D-A60RN	MC3D-A60VRB	MC3D-A60VRN				
		3PDT	MC3D-A70RB	MC3D-A70RN	MC3D-A70VRB	MC3D-A70VRN				
Pilot Light	—	—	MC3D-P00RB	MC3D-P00RN	MC3D-P00VRB	MC3D-P00VRN			Order Separately	

Note 1: Specify a color code in place of * in the LED lamp Part No.: A (amber), G (green), PW (pure white), R (red), S (blue), W (white), Y (yellow)
 Note 2: For white and pure white illumination, use a clear (C) color screen.

Dimensions

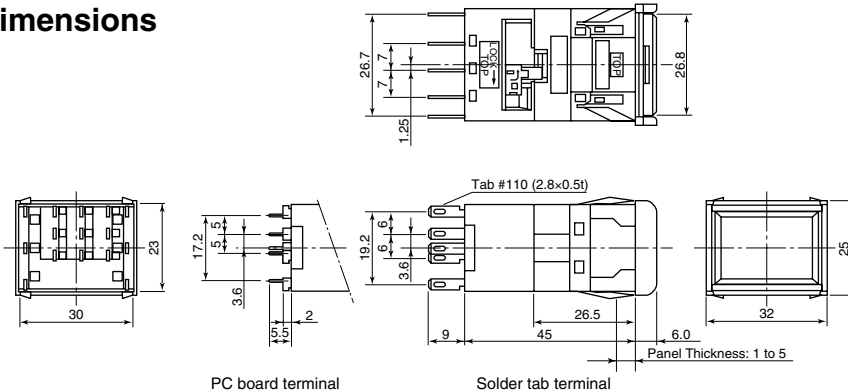

PC Board Drilling Layout (PC Board Terminal)

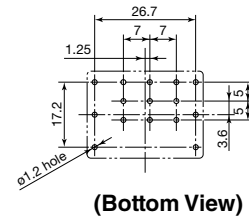

(Bottom View)

• See Single Board Mounting on page 37 for details about PC boards.

All dimensions in mm.

• For panel cut-out, see page 33.

Internal Connection (Bottom View)

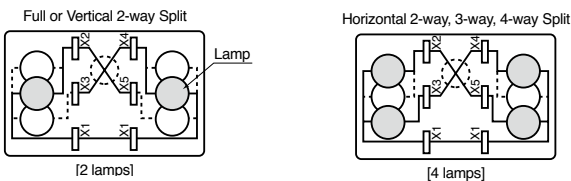

- Because terminals X2 through X5 are connected together internally, external jumper wiring is not needed for full illumination.
- When using split illumination, cut out the internal jumper using the jumper cutter (MC9Z-J1). See page 36.
- LED or incandescent lamps are not supplied and must be ordered separately.

- For incandescent illumination (full only), use only 2 lamps.
- For split illumination, use LED lamps.

Internal Connection (Bottom View)

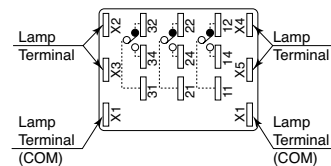

When using LFTD-5
 X1 (COM): Negative
 X2 to X5: Positive

- SPDT contact type has lamp terminals and contact terminals in the middle only.
- DPDT contact type has lamp terminals and contact terminals on both sides (not in the middle).
- Pilot light has lamp terminals only.

MC Series Illuminated Pushbuttons / Pilot Lights

MC3D-**0F (Rectangular Horizontal / Flange)

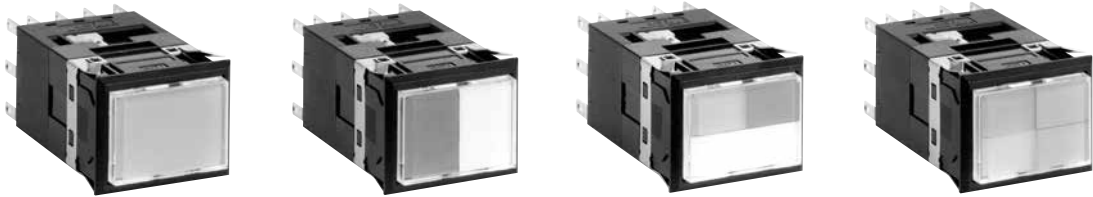

(except pilot light)

Full



2-way Split



3-way Split



4-way Split



Package Quantity: 1

Operation	Contact	Part No.				Marking Plate	Color Screen	Light Source	
		Solder/Tab Terminal		PC Board Terminal					
		Housing Color: Black	Housing Color: Gray	Housing Color: Black	Housing Color: Gray				
Momentary (Snap Action)	Silver	SPDT	MC3D-M10FB	MC3D-M10FN	—	—	White Size: 24.8 x 17 x 1 mm Material: Acrylic	Amber Clear Green Red Blue Yellow	Applicable LED Lamp 24V AC/DC: LFTD-2* 12V AC/DC: LFTD-1* 6V AC/DC: LFTD-6* 5V DC: LFTD-5*
		DPDT	MC3D-M20FB	MC3D-M20FN	—	—			
		3PDT	MC3D-M30FB	MC3D-M30FN	—	—			
	Gold	SPDT	MC3D-M50FB	MC3D-M50FN	MC3D-M50VFB	MC3D-M50VFN			
		DPDT	MC3D-M60FB	MC3D-M60FN	MC3D-M60VFB	MC3D-M60VFN			
		3PDT	MC3D-M70FB	MC3D-M70FN	MC3D-M70VFB	MC3D-M70VFN			
Momentary (Slow Action)	Silver	SPDT	MC3D-S10FB	MC3D-S10FN	—	—	Material: Acrylic	Material: Acrylic	Applicable Incandescent Lamp 28V: LH-28 14V: LH-14 6V: LH-06
		DPDT	MC3D-S20FB	MC3D-S20FN	—	—			
		3PDT	MC3D-S30FB	MC3D-S30FN	—	—			
	Gold	SPDT	MC3D-S50FB	MC3D-S50FN	MC3D-S50VFB	MC3D-S50VFN			
		DPDT	MC3D-S60FB	MC3D-S60FN	MC3D-S60VFB	MC3D-S60VFN			
		3PDT	MC3D-S70FB	MC3D-S70FN	MC3D-S70VFB	MC3D-S70VFN			
Maintained	Silver	SPDT	MC3D-A10FB	MC3D-A10FN	—	—	Supplied	Order Separately	Order Separately
		DPDT	MC3D-A20FB	MC3D-A20FN	—	—			
		3PDT	MC3D-A30FB	MC3D-A30FN	—	—			
	Gold	SPDT	MC3D-A50FB	MC3D-A50FN	MC3D-A50VFB	MC3D-A50VFN			
		DPDT	MC3D-A60FB	MC3D-A60FN	MC3D-A60VFB	MC3D-A60VFN			
		3PDT	MC3D-A70FB	MC3D-A70FN	MC3D-A70VFB	MC3D-A70VFN			
Pilot Light	—	MC3D-P00FB	MC3D-P00FN	MC3D-P00VFB	MC3D-P00VFN				

Note 1: Specify a color code in place of * in the LED lamp Part No.: A (amber), G (green), PW (pure white), R (red), S (blue), W (white), Y (yellow)
 Note 2: For white and pure white illumination, use a clear (C) color screen.
 • The rectangular flange unit can be mounted vertically. Replace the leaf springs with optional vertical mounting leaf springs (MC9Z-T3).

Dimensions

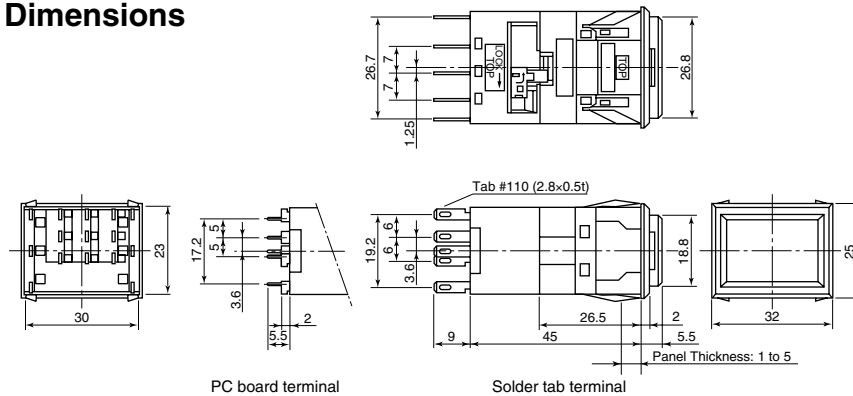

PC Board Drilling Layout (PC Board Terminal)

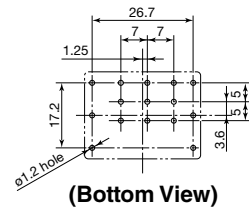

• See Single Board Mounting on page 37 for details about PC boards.

All dimensions in mm.

• For panel cut-out, see page 33.

Internal Connection (Bottom View)

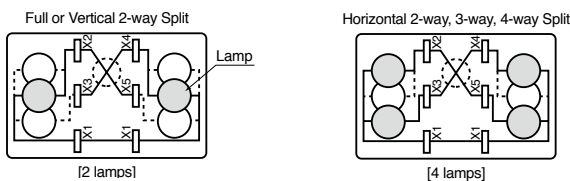

- Because terminals X2 through X5 are connected together internally, external jumper wiring is not needed for full illumination.
- When using split illumination, cut out the internal jumper using the jumper cutter (MC9Z-J1). See page 36.
- LED or incandescent lamps are not supplied and must be ordered separately.

- For incandescent illumination (full only), use only 2 lamps.
- For split illumination, use LED lamps.

Terminal Arrangement (Bottom View)

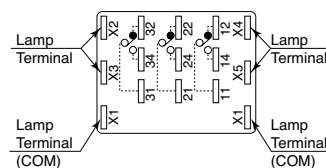

When using LFTD-5
 X1 (COM): Negative
 X2 to X5: Positive

- SPDT contact type has lamp terminals and contact terminals in the middle only.
- DPDT contact type has lamp terminals and contact terminals on both sides (not in the middle).
- Pilot light has lamp terminals only.

MC Series Illuminated Pushbuttons / Pilot Lights

MC2D-**0 (Square / Flange)



Full
□



2-way Split
□



(except pilot light)

Package Quantity: 1

Operation	Contact	Part No.				Marking Plate	Color Screen	Light Source	
		Solder/Tab Terminal		PC Board Terminal					
		Housing Color: Black	Housing Color: Gray	Housing Color: Black	Housing Color: Gray				
Momentary (Snap Action)	Silver	SPDT	MC2D-M10B	MC2D-M10N	—	—	White Size: 17 x 17 x 1 mm Material: Acrylic	Applicable LED Lamp 24V AC/DC: LFTD-2* 12V AC/DC: LFTD-1* 6V AC/DC: LFTD-6* 5V DC: LFTD-5*	
	DPDT	MC2D-M20B	MC2D-M20N	—	—				
Momentary (Slow Action)	Gold	SPDT	MC2D-M50B	MC2D-M50N	MC2D-M50VB	MC2D-M50VN			
	DPDT	MC2D-M60B	MC2D-M60N	MC2D-M60VB	MC2D-M60VN				
Momentary (Slow Action)	Silver	SPDT	MC2D-S10B	MC2D-S10N	—	—			
	DPDT	MC2D-S20B	MC2D-S20N	—	—				
Momentary (Slow Action)	Gold	SPDT	MC2D-S50B	MC2D-S50N	MC2D-S50VB	MC2D-S50VN			
	DPDT	MC2D-S60B	MC2D-S60N	MC2D-S60VB	MC2D-S60VN				
Maintained	Silver	SPDT	MC2D-A10B	MC2D-A10N	—	—			
	DPDT	MC2D-A20B	MC2D-A20N	—	—				
Maintained	Gold	SPDT	MC2D-A50B	MC2D-A50N	MC2D-A50VB	MC2D-A50VN			
	DPDT	MC2D-A60B	MC2D-A60N	MC2D-A60VB	MC2D-A60VN				
Pilot Light	—	—	MC2D-P00B	MC2D-P00N	MC2D-P00VB	MC2D-P00VN	Supplied	Order Separately	Order Separately

Note 1: Specify a color code in place of * in the LED lamp Part No.: A (amber), G (green), PW (pure white), R (red), S (blue), W (white), Y (yellow)
 Note 2: For white and pure white illumination, use a clear (C) color screen.

- 2-way split unit can be mounted vertically. Replace the leaf springs with optional vertical mounting leaf springs (MC9Z-T3).

Dimensions

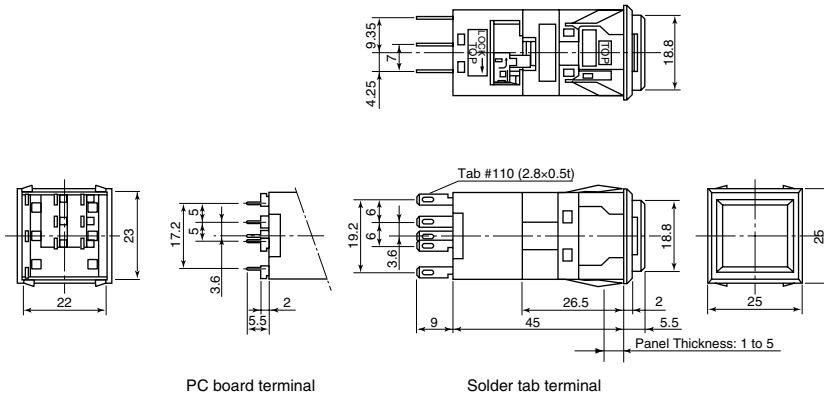

PC Board Drilling Layout (PC Board Terminal)

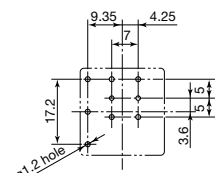

(Bottom View)

- See Single Board Mounting on page 37 for details about PC boards.

All dimensions in mm.

- For panel cut-out, see page 33.

Internal Connection (Bottom View)

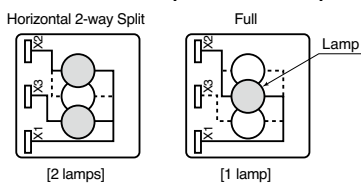

Terminal Arrangement (Bottom View)

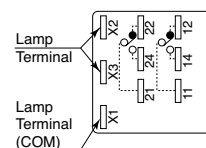









When using LFTD-5
 X1 (COM): Negative
 X2 to X5: Positive

- LED or incandescent lamps are not supplied and must be ordered separately.
 • For incandescent illumination (full only), use only 1 lamp.
 • For horizontal 2-way split illumination, use LED lamps.

- SPDT contact has lamp terminals and contact terminals on the right only.
 • Pilot light has lamp terminals only.

MC Series Accessories

Accessories

Name & Shape	For Use On	Specifications	Part No.	Ordering No.	Package Quantity	Remarks	
Lamp Holder Removal Tool 	All Series	—	MCM-T001	MCM-T001	1	<ul style="list-style-type: none"> Used to remove the lamp holder from the housing. Material: Stainless Steel 	
Jumper Cutter 	MC3D	—	MC9Z-J1	MC9Z-J1	1	<ul style="list-style-type: none"> Used to cut the built-in jumper when changing the MC3D for 2-way, 3-way, or 4-way split illumination. See page 36. Material: Metal 	
Switch Guard with Lens 	MC3D	Horizontal type	MC9Z-KF3	MC9Z-KF3	1	<ul style="list-style-type: none"> Used in place of the standard lens to protect the operator, and can be installed in the same manner as the standard lens. When guard barriers are installed, the lens switch cut-out cannot be used. Material: Polycarbonate 	
		Vertical type	MC9Z-KT3	MC9Z-KT3	1		
	MC2D	Horizontal type	MC9Z-KF2	MC9Z-KF2	1		
Barrier  End Barrier Spacer Barrier	MC3D Horizontal Flange MC2D	End barrier	Black	MC9Z-BF1B	MC9Z-BF1BPN10	10	<ul style="list-style-type: none"> The barrier is used to separate adjoining operators of flange type MC3D/2D units to prevent inadvertent operation and to improve panel appearance. See page 33 for panel cut-out. Material: Polycarbonate
			Gray	MC9Z-BF1N	MC9Z-BF1NPN10		
	MC3D Vertical Flange	Spacer barrier	Black	MC9Z-BF2B	MC9Z-BF2BPN10	10	
			Gray	MC9Z-BF2N	MC9Z-BF2NPN10		
		End barrier	Black	MC9Z-BT1B	MC9Z-BT1BPN10	10	
			Gray	MC9Z-BT1N	MC9Z-BT1NPN10		
Spacer barrier	Black	MC9Z-BT2B	MC9Z-BT2BPN10	10			
	Gray	MC9Z-BT2N	MC9Z-BT2NPN10				
Guard Barrier  End Guard Barrier Spacer Guard Barrier	MC3D Horizontal Flange MC2D Horizontal	End guard barrier	Black	MCM-BF3B	MCM-BF3BPN10	10	<ul style="list-style-type: none"> The guard barrier is used to surround the operator of flange type MC3D/2D units for preventing inadvertent operation. The guard barrier cannot be used on barrier type or vertical flange type MC3D units. See page 33 for panel cut-out. Material: Polyamide
			Gray	MCM-BF3N	MCM-BF3NPN10		
	Spacer guard barrier	Black	MCM-BF4B	MCM-BF4BPN10	10		
		Gray	MCM-BF4N	MCM-BF4NPN10			
Terminal Socket 	MC3D	With solder terminals	MC9Z-C3	MC9Z-C3	1	<ul style="list-style-type: none"> Material: Polyamide 	
		With PC board terminals	MC9Z-C3V	MC9Z-C3V	1		
	MC2D	With solder terminals	MC9Z-C2	MC9Z-C2	1		
		With PC board terminals	MC9Z-C2V	MC9Z-C2V	1		
Terminal Cover 	MC3D	—	MC9Z-VL23	MC9Z-VL23	5	<ul style="list-style-type: none"> When wiring, insert lead wires through terminal cover holes before soldering the lead wires to the MC3D/2D terminals. White Material: PBT 	
	MC2D	—	MC9Z-VL22	MC9Z-VL22	5		
Dustproof Cover 	MC3D	Flange (horizontal/vertical)	MCM-D3	MCM-D3	1	<ul style="list-style-type: none"> The dustproof cover is not waterproof. See page 33 for panel cut-out. Material: Base: Polypropylene, Cover: PVC elastomer 	
	MC2D	Flange	MCM-D2	MCM-D2	1		
Vertical Mounting Leaf Spring 	MC3D MC2D	—	MC9Z-T3	MC9Z-T3PN10	10	<ul style="list-style-type: none"> Leaf springs for mounting the flange type MC3D vertically. When using the vertical mounting leaf springs, remove the existing leaf springs from the MC3D and install the vertical mounting leaf springs. See page 35. Material: Stainless Steel 	

MC Series Accessories

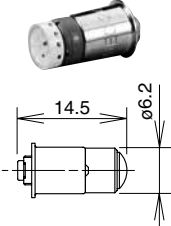
Accessories							
Name & Shape	Operating Voltage	Rated Current	Part No.	Ordering No.	Illumination Color Code	Package Quantity	Base
LFTD LED Lamp 	5V DC±5%	8 mA	LFTD-5*	LFTD-5*	Specify a color code in place of * in the Ordering Part No.	1	SX6S/8x5.4
				LFTD-5*PN10		10	
	6V AC/DC±5%	7 mA	LFTD-6*	LFTD-6*	A: amber G: green PW: pure white R: red S: blue W: white	1	
				LFTD-6*PN10		10	
	12V AC/DC±10%	8 mA	LFTD-1*	LFTD-1*	Use a PW (pure white) LED lamp for yellow illumination.	1	
				LFTD-1*PN10		10	
	24V AC/DC±10%	8 mA	LFTD-2*	LFTD-2*	1		
				LFTD-2*PN10	10		

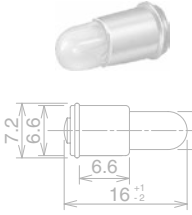
Name & Shape	Operating Voltage	Rated Voltage	Rated Current	Part No.	Ordering No.	Package Quantity
LH Incandescent Lamp 	5V AC/DC	6V	0.1A	LH-06	LH-06	1
	12V AC/DC	14V	0.05A	LH-14	LH-14	1
	24V AC/DC	28V	0.025A	LH-26	LH-26	1

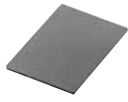
Name & Shape	For Use On	Specifications	Part No.	Ordering No.	Package Quantity	Remarks
Color Screen 	MC3D	Full illumination	MC9Z-PA3*	MC9Z-PA3*PN05	1 set (5 pcs)	Specify a color code in place of * in the Ordering No. A: amber C: clear GD: green for LED GL: green for incandescent lamps R: red S: blue Y: yellow
		Horizontal 2-way split	MC9Z-3DB	MC9Z-3DB	1 set	
		Vertical 2-way split	MC9Z-3DC	MC9Z-3DC	1 set	
		Horizontal 3-way split	MC9Z-3DD	MC9Z-3DD	1 set	
		Vertical 3-way split	MC9Z-3DE	MC9Z-3DE	1 set	
		4-way split	MC9Z-3DF	MC9Z-3DF	1 set	
	MC2D	Full illumination	MC9Z-PA2*	MC9Z-PA2*PN05	1 set (5 pcs)	Use a clear (C) screen for white or pure white illumination.
		Horizontal 2-way split	MC9Z-2DB	MC9Z-2DB	1 set	

Accessories (Dimensions)

Lens Switch Guard

For MC3D Horizontal (MC9Z-KF3)

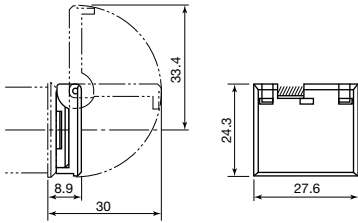

For MC3D Vertical (MC9Z-KT3)

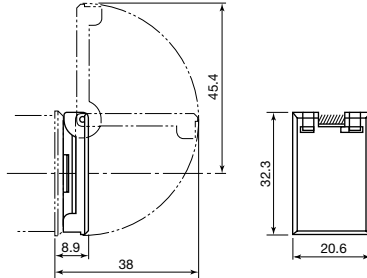

For MC2D (MC9Z-KF2)

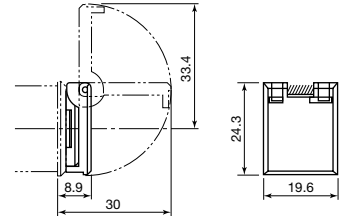

Barrier

When using on MC3D Horizontal Flange

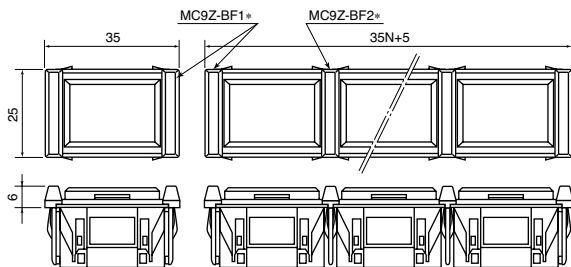

When using on MC3D Vertical Flange

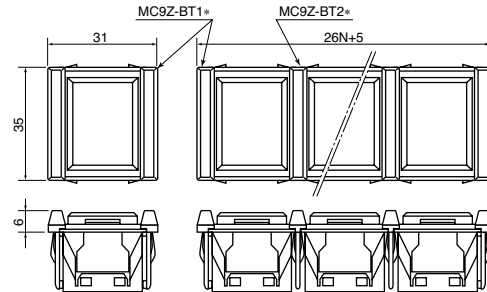

When using on MC2D

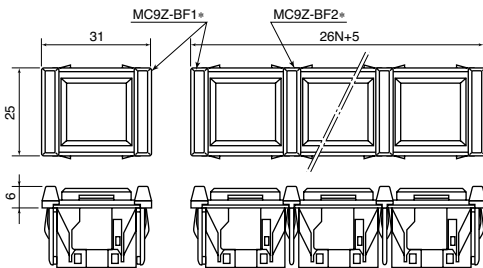

Guard Barrier

When using on MC3D Horizontal Flange

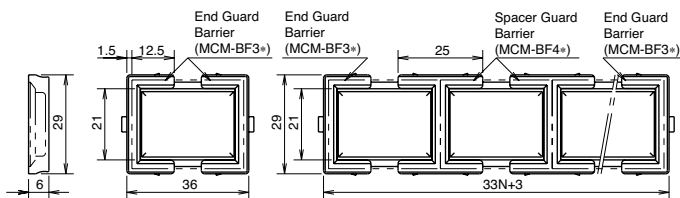

When using on MC2D

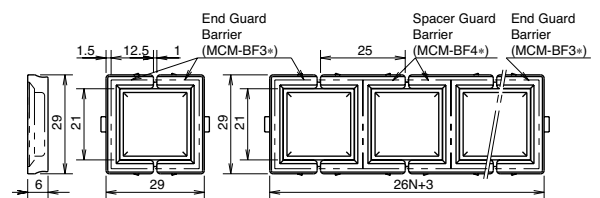

Terminal Cover

For MC3D (MC9Z-VL23)

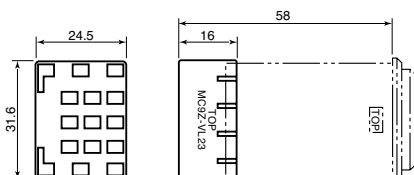

For MC2D (MC9Z-VL22)

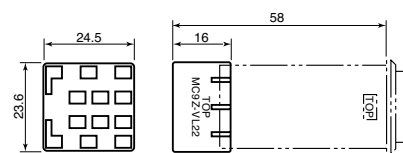

All dimensions in mm.

MC Series Accessories / Maintenance Parts

Accessories (Dimensions)

Socket

For MC3D

With solder terminals (MC9Z-C3)

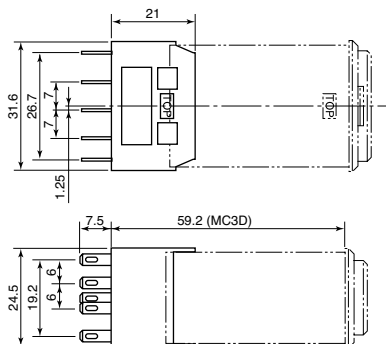

With PC board terminals (MC9Z-C3V)

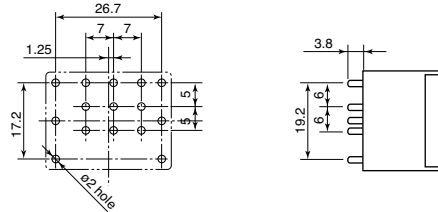

PC Board Drilling Layout (Bottom View)

For MC2D

With solder terminals (MC9Z-C2)

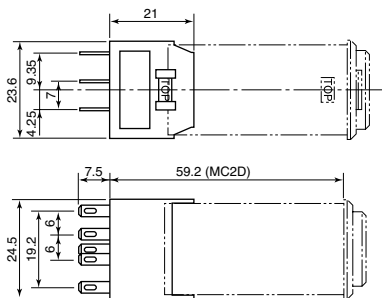

With PC board terminals (MC9Z-C2V)

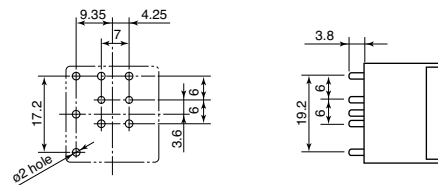

PC Board Drilling Layout (Bottom View)

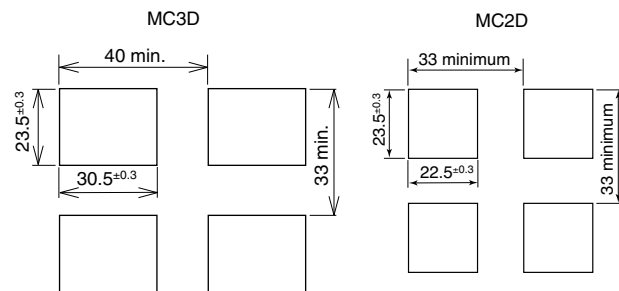
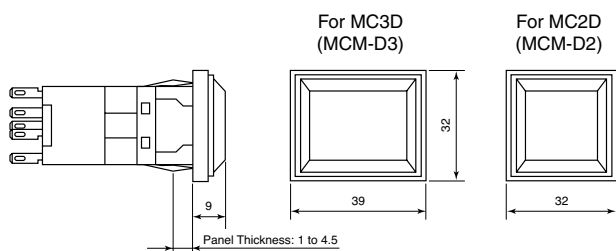

Dustproof Cover

Panel Cut-out



All dimensions in mm.

Maintenance Parts

Name & Shape	For Use On	Specifications	Part No.	Ordering No.	Package Quantity	Remarks
	MC3D	17 × 24.8 × 1 mm	MC9Z-P3W	MC9Z-P3WPN05	5	<ul style="list-style-type: none"> Color: white One marking plate is supplied with each MC3D/2D unit. Material: Acryl
	MC2D	17 × 17 × 1 mm	MC9Z-P2W	MC9Z-P2WPN05	5	
	MC3D	4-way split	MC9Z-S3	MC9Z-S3PN05	5	<ul style="list-style-type: none"> Supplied with split color screens. Material: PBT
	MC2D	2-way split	MC9Z-S2	MC9Z-S2PN05	5	
	MC3D	—	MC9Z-L3	MC9Z-L3PN05	5	<ul style="list-style-type: none"> Material: Polycarbonate
	MC2D	—	MC9Z-L2	MC9Z-L2PN05	5	

MC Series Panel Cut-Out

Panel Cut-Out

Model		Front View	Panel Cut-Out		Remarks
Barrier	MC3D Horizontal				<p>N: No. of MC units mounted</p> <p>Notes:</p> <ul style="list-style-type: none"> When all four LED lamps are lit continuously, the maximum number of MC3D units that can be mounted is 3 rows by 10 columns. When both LED lamps are lit continuously, the maximum number of MC2D units that can be mounted is 10 rows by 10 columns. The panel cut-out dimensions are identical whether the MC3D/MC2D is mounted with or without a dustproof cover. See page 32. The applicable panel thickness is 1 to 5 mm. The strength of the panel must be taken into consideration for collective mounting.
	MC3D Horizontal				
Flange	MC3D Vertical				
	MC2D Horizontal				
Flange with Barriers	MC3D Horizontal				
	MC3D Vertical				
	MC2D				
Flange with Guard Barriers	MC3D Horizontal				
	MC2D				

All dimensions in mm.

MC Series Instructions

Ordering Information

Notes for Ordering

- MC3D/2D units are not supplied with LED lamps, **incandescent lamps** and color screens. Order these accessories separately. When ordering, specify the Ordering No. and quantity. **[Example]**
- MC3D Horizontal Barrier, Momentary Operation (snap action), Silver Contact, SPDT, Black Housing, Full Illumination
Part No.: MC3D-M10RB 5 pcs
- LED Lamp (6V AC/DC, Red)
Part No.: LFTD-6RPN10 1 pack (10 pcs/pack)

- Color Screen (Full, Red)
Part No.: MC9Z-PA3RPN05 1 pack (5 pcs of the same color)

Other Notes

- Sockets, lens switch guard, barriers, and guard barriers are ordered separately. When ordering these accessories, specify the Ordering Part No. and quantity.
- When using MC3D flange in vertical alignment, order vertical mounting leaf springs (MC9Z-T3) separately, and replace the existing leaf springs on the MC3D vertical flange. See page 35.

Safety Precautions

- Turn power off to the MC series before installation, removal, wiring, maintenance, or inspection. Failure to turn power off may cause electrical shocks or fire hazard.
- Use the MC series within the specification values. Exceeding the specification values may cause electrical shocks or fire hazard.
- Use wires of proper size to meet the voltage and current requirements. Solder the wires correctly to the terminals. Incomplete soldering will cause excessive heating and fire hazard.

Instructions

Illumination Unit

Removing the Illumination Unit

Use the lamp holder removal tool (MCM-T001) to pull out the illumination unit, nipping the slots on the sides of the lens. If the cover of the lens with switch guard is pulled, the hinge of the cover may be damaged. Pull out the illumination unit, nipping the lens.

Installation and Replacement of LED **Incandescent** Lamps

Insert the LED **or incandescent** lamp into the lamp receptacle from the rear of the lamp holder, bulb first. Push the lamp in completely.

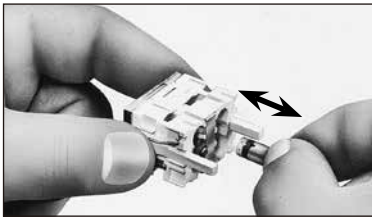

Replacing the Lens (Removal)

Remove the illumination unit as described above. Insert a flat screwdriver into the latch between the lens and lens holder, and remove the lens.



(Installation)

Put the latches on both sides of the lens onto the latches on the lens holder, and depress the lens surface lightly.

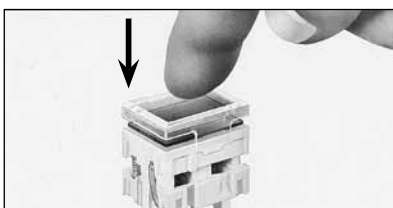

Mounting Order of Color Screen and Marking Plate

Insert the color screen and marking plate in the order described below.

Illumination Color (Lamp On)	Display Color (Lamp Off)	Order Insertion
Amber, Green, Red	Color	B
Blue, Yellow	White	A
Pure White, White	White	A or B

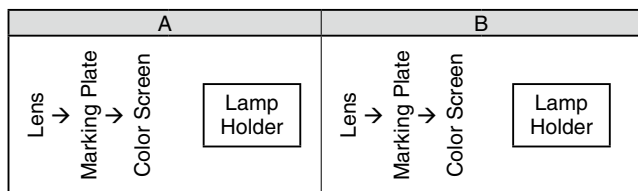

Illumination Color and LED Lamp

Insert the color screen and marking plate in the proper order as described below.

Illumination Color	Color Screen	LED Lamp
Amber	Amber	Amber
Red	Red	Red
Green	Green	Green
Blue	Blue	Blue
White	Clear	White
Yellow	Yellow	Yellow
Pure White	Clear	Pure White

- Note:
- Marking plates are identical in material and thickness.
 - Engraving is possible on both marking plates and screens.

Using the Light Barrier

A light barrier is supplied with color plates for split illumination. Use the light barrier according to the required split color illumination.

MC3D (Rectangular)

[Full Illumination] Light barrier is not needed.

[2- or 3-way Split] Cut off the unnecessary part using cutting pliers.

[4-way Split] Use the light barrier for 4-way split illumination as it is.

MC2D (Square)

[Full Illumination] Light barrier is not needed.

[2-way Split] Install the light barrier for 2-way horizontal split illumination correctly.

Instructions

Handling the Light Barrier (Replacing the Light Barrier)

When inserting, note the orientation of the light barrier, illumination unit, and housing.

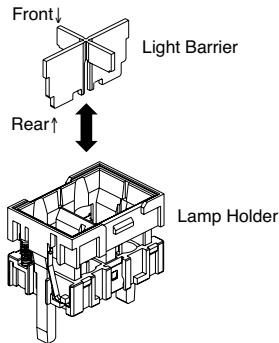

(Cutting the Light Barrier)

Cut off the unnecessary part using cutting pliers.

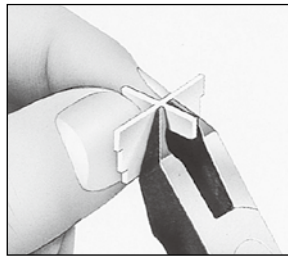

Installing the Illumination Unit into the Housing

The illumination unit has an orientation for insertion into the MC3D/2D housing.

[MC3D]

Place the ▲ mark on the lamp holder in the same direction as the TOP marking on the housing, and insert the illumination unit.

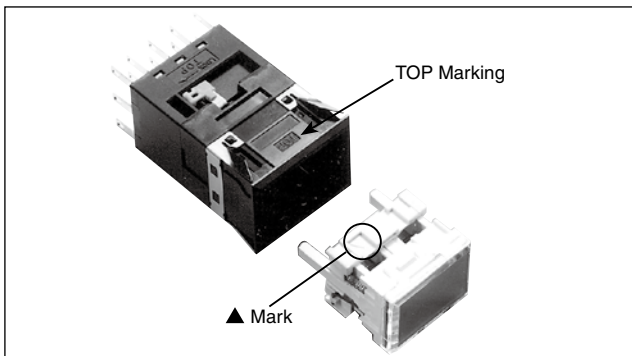

Vertical Mounting

First, insert a small flat-blade screwdriver under the leaf spring on the MC unit, and remove the leaf spring for horizontal mounting.

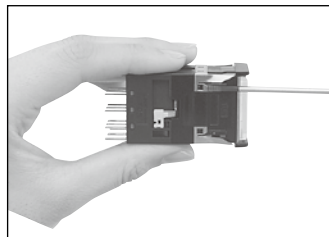

Place the vertical leaf spring on the MC unit temporarily, and then press the spring until it is secured on the MC unit.

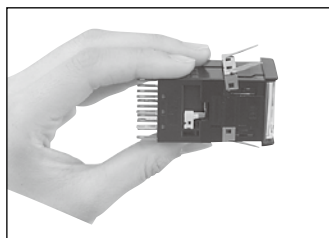

Removing the Contact Block

Removal

Push the yellow lever latch on the top surface of the housing in the direction of arrow using a small screwdriver. The yellow lever latch will rise up. Then turn the lever in the opposite direction indicated with Lock →. The contact block is unlocked and can be removed from the operator housing.

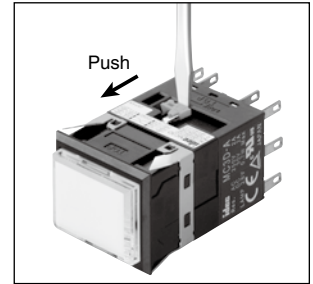

Installation

Open the lever as described above, and align the TOP markings on the operator housing and contact block in the same direction. Insert the contact block into the operator housing, and turn the lever in the direction indicated with Lock →. The contact block is locked to the operator housing.

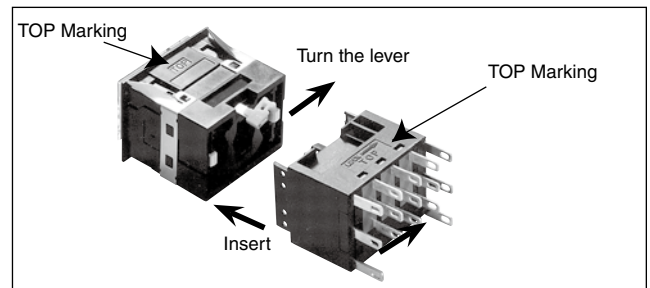

Installing Accessories

Installing the Socket or Terminal Cover

Align the TOP markings on the operator housing and socket or terminal cover in the same direction, and press the socket or terminal cover toward the housing.

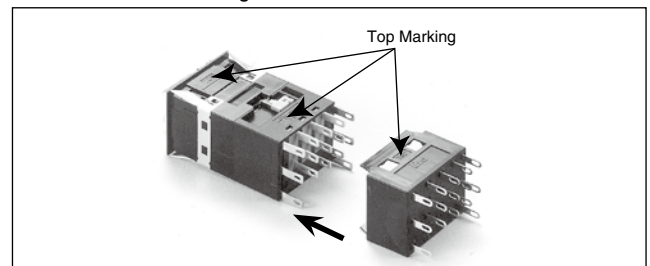

Installing the Lens with Switch Guard

The lens with switch guard can be installed and removed as with the standard lens. See Installation and Replacement of LED/[incandescent](#) Lamps on page 34.

[Single Mounting]

Put end barriers on both sides of the housing and insert it into the panel cut-out from the front.

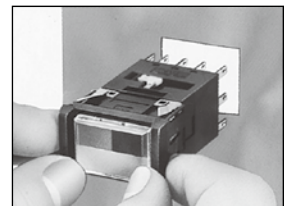

[Row Mounting]

Insert an end barrier at one end of the panel cutout, then a unit, a spacer barrier, another unit, and so forth up to the other end of the row. With another end barrier in place, insert the last unit before inserting the last spacer barrier.

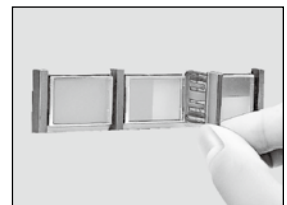

MC Series Instructions

Instructions

Cutting the Built-in Jumper

The MC3D has a built-in jumper for full illumination. When using the MC3D for split illumination, cut out the jumper ⊗ in the housing, using the jumper cutter (MC9Z-J1). When cutting the built-in jumper, remove the contact block and illumination unit. Place the operator housing upright, insert the jumper cutter, and turn the jumper cutter to cut out the jumper. Remove the cut jumper from the housing. Always use the MC9Z-J1 jumper cutter, otherwise the internal elements may be damaged. Do not touch the lamp contacts, which are easily deformed.

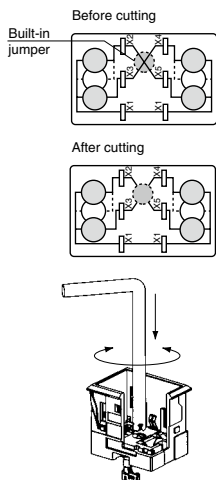

Wiring Precautions

Run the LED illumination wiring away from other motor lines. Solder the terminals at 350°C within 3 seconds, using a 60W soldering iron. Sn-Ag-Cu solder is recommended. While soldering, keep the soldering iron as far from the plastic part of the switch as possible. Do not apply excessive force while soldering the terminal.

Notes for Operation

When Using LED Lamps

When using the MC series for full illumination, make sure of correct number of lamps.

(Number of Lamps)

MC3D: 2 LED lamps

MC2D: 1 LED lamp

(Leage Current)

The LED lamp may light dimly due to a leakage current or induction current from the solid-state switch or contact protection circuit used for the LED lamp. Take a measure, if necessary.

(Installation Location)

Do not install the LED illuminated MC series where the LED lamps are subjected to infrared rays.

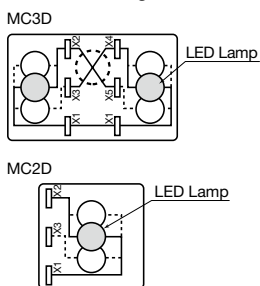

When Using Incandescent Lamps

Use IDEC LH series 0.5W incandescent lamps. Use two incandescent lamps for the MC3D although the MC3D has four lamp receptacles. Use one incandescent lamp for the MC2D.

Microswitch Contacts

When inductive loads are switched, arcing will increase contact resistance, so it is recommended to connect a contact protection circuit for higher contact reliability.

Slow Action Type

On the momentary slow action 3PDT type, the three microswitches may operate at a slightly different timing.

Connection

Positive-lock connector and easy-lock connectors are applicable to tab terminals.

Item	Positive-lock Connector (Tyco Electronics)	Easy-lock Connector (Nichifu Co., Ltd)	
Terminal	0.2 to 0.5 mm ²	0.2 to 0.3 mm ²	OSS-62852F3
	0.2 to 1.25 mm ²	0.5 to 1.25 mm ²	OSS-62815F3
Housing	174779-1	NET1-28-1P	

Note: Positive-lock is a registered trademark of Tyco Electronics.

Single Board Mounting

Mounting MC series illuminated control units on a PC board offers the following features.



Features

- Reduced installation labor, easy wiring, space saving, and standardization.
- Because the contact blocks on the PC board can be removed easily using a locking lever, the MC series control units are easy to maintain.
- Because the MC series control units require no studs for fastening the control unit to a PC board, special preparation of the control panel is not needed.

Notes for Designing PC Board and Circuit

- Use 1.6-mm-thick glass epoxy PC board with drilled holes.
- Design a circuit so that the MC series control unit can operate within the rated voltage and current range. Make sure that inrush current and voltage do not exceed the rating.
- Minimum applicable load is 5V AC/DC, 1 mA on gold contacts. Applicable range is subject to the operating condition and load.
- Because the 2.8-mm wide terminal touches the PC board as shown on the right, short circuit may occur with pattern lines. Design a circuit carefully to prevent short circuit.

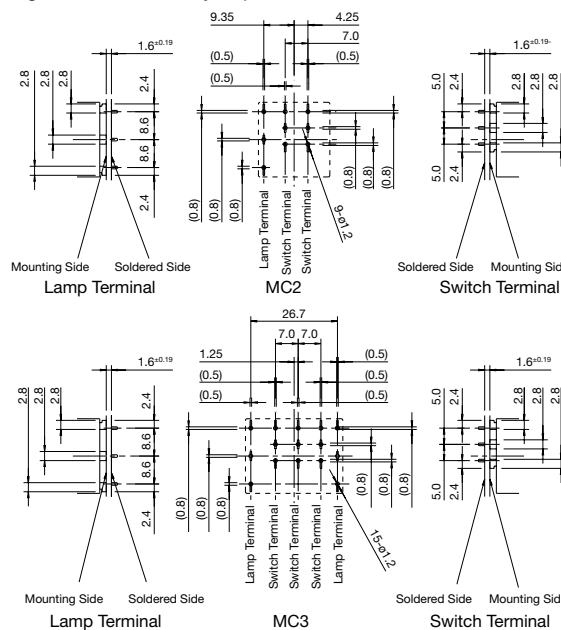

PC Board Drilling Layout (Bottom View)

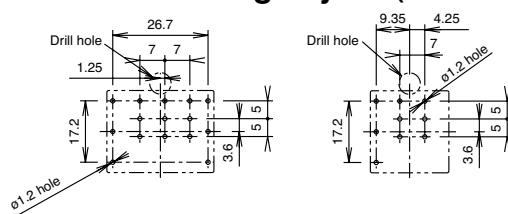

- Note 1: When designing, note the alignment of center lines of the contact blocks and center lines of the operators.
 Note 2: The diameter of the terminal hole is 1.2 mm. Drill hole will enable easy operation of the locking lever.

Specifications and other descriptions in this brochure are subject to change without notice.



IDEC CORPORATION

IDEC CORPORATION (USA)
 Tel: +1-408-747-0550 / (800) 262-IDEC (4332)
 E-mail: opencontact@idec.com
 IDEC CANADA LIMITED
 Tel: +1-905-890-8561, Toll Free: (888) 262-IDEC (4332)
 E-mail: sales@ca.idec.com
 IDEC AUSTRALIA PTY. LTD.
 Tel: +61-3-8523-5900, Toll Free: 1800-68-4332
 E-mail: sales@au.idec.com

IDEC ELEKTROTECHNIK GmbH
 Tel: +49-40-25 30 54 - 0 E-mail: service@eu.idec.com
 IDEC (SHANGHAI) CORPORATION
 Tel: +86-21-6135-1515 E-mail: idec@cn.idec.com
 IDEC (BEIJING) CORPORATION
 Tel: +86-10-6581-6131
 IDEC (SHENZHEN) CORPORATION
 Tel: +86-755-8356-2977

IDEC IZUMI (H.K.) CO., LTD.
 Tel: +852-2803-8989 E-mail: info@hk.idec.com
 IDEC TAIWAN CORPORATION
 Tel: +886-2-2698-3929 E-mail: service@tw.idec.com
 IDEC IZUMI ASIA PTE. LTD.
 Tel: +65-6746-1155 E-mail: info@sg.idec.com
 IDEC ASIA (THAILAND) CO.,LTD.
 Tel: +662-392-9765, E-mail: sales@th.idec.com